





Large-Size Rolling Bearings



Technical Information	Page No. A7	Tech. Info.
Deep Groove Ball Brgs.	B4	
Angular Contact Ball Brgs.	B20	
Cylindrical Roller Brgs.	B44	
Full-Complement Cylindrical Roller Brgs.	B78	
Tapered Roller Brgs.	B96	
Spherical Roller Brgs.	B286	
Thrust Brgs.	B308	
Rolling Bearings For Steel Mills	B334	Steel Mills
Triple-Ring Brgs.	B436	Triple
Crossed Roller Brgs.	B440	Crossed
Special NSK Bearings And Related Equipment	C2	Special
Application Drawings	C14	Appl.
Appendices	C32	Appendices
Index of Inch Design Tapered Roller Brgs.	C50	Index

Introduction to NSK Large-Size Rolling Bearing Catalog (CAT. No. E125f)

We want to thank you for your interest in this edition of our Large-Size Rolling Bearing Catalog.

Recently, operating requirements for machines and other equipment that use rolling bearings have become increasingly severe and diversified. Accordingly, rolling bearings, which are highly important machine elements, must be designed to satisfy more and more stringent requirements for higher speeds, greater precision, higher reliability, and other challenging demands.

We edited this Large-Size Rolling Bearing Catalog to reflect the growing number of NSK products, new developments, and technical progress. In it, you will find a wide range of bearings that will satisfy almost any requirement; however, special bearings not listed here are available by contacting NSK.

The first part (A pages) contains general information about rolling bearings to facilitate selection of the most appropriate type. Next, supplementary technical information is provided peculiar to each bearing type at the beginning of the section devoted to each type (B pages). Also, there is an explanation about special-purpose bearings, mostly for steel mill roll necks.

In the dimensional tables, bearings are listed in the order of increasing bore size. The data shown for each bearing includes the boundary dimensions, bearing load ratings, abutment and fillet dimensions, and mass.

At the end, NSK products and certain applications specially designed to meet particular conditions are shown. These may be helpful regarding bearing selection and the design of surrounding parts.

Data in this catalog are given in both the International Unit System (SI) and Engineering Unit System (Gravitational System of Units).

We hope this catalog will allow you to select the optimum bearing for your application. However, if assistance is required, please contact NSK, and the company's engineers and computer programs can quickly supply the information you need.

CONTENTS

TECHNICAL INFORMATION

	Page No.
1 SELECTION OF BEARING SIZE	A 7
1.1 Bearing Life	A 7
1.2 Basic Dynamic Load Rating and Fatigue Life	A 7
1.3 Calculation of Bearing Loads	A10
1.4 Dynamic Equivalent Load	A11
1.5 Basic Static Load Ratings and Static Equivalent Loads	A12
2 BEARING TOLERANCES	A13
2.1 Bearing Tolerance Standards	A13
3 FITS AND INTERNAL CLEARANCES	A33
3.1 Fits	A33
3.2 Bearing Internal Clearances	A39
4 LUBRICATION	A46
4.1 Purposes of Lubrication	A46
4.2 Lubricating Methods	A46
4.3 Lubricants	A50
5 BEARING MATERIALS	A54
5.1 Materials for Bearing Rings and Rolling Elements	A54
5.2 Cage Materials	A55

BEARING TABLES

	Page No.
SINGLE-ROW DEEP GROOVE BALL BEARINGS	B 4
ANGULAR CONTACT BALL BEARINGS	B 20
CYLINDRICAL ROLLER BEARINGS	B 44
FULL-COMPLEMENT CYLINDRICAL ROLLER BEARINGS	B 78
TAPERED ROLLER BEARINGS	B 96
SPHERICAL ROLLER BEARINGS	B286
THRUST BEARINGS	B308
ROLLING BEARINGS FOR STEEL MILLS	B334
TRIPLE-RING BEARINGS FOR PAPER MAKING MACHINES	B436
CROSSED-ROLLER BEARINGS FOR INDUSTRIAL ROBOTS	B440
SPECIAL NSK BEARINGS AND RELATED EQUIPMENT	C 2
APPLICATION DRAWINGS	C 14
APPENDICES	C 32
INDEX OF INCH DESIGN TAPERED ROLLER BEARINGS	C 50

1. SELECTION OF BEARING SIZE

1.1 Bearing Life

The various functions required of rolling bearings vary according to the bearing application. These functions must be performed for a prolonged period. Even if bearings are properly mounted and correctly operated, they will eventually fail to perform satisfactorily due to an increase in noise and vibration, loss of running accuracy, deterioration of grease, or fatigue flaking of the rolling surfaces.

Bearing life, in the broad sense of the term, is the period during which bearings continue to operate and to satisfy their required functions. This bearing life may be defined as noise life, abrasion life, grease life, or rolling fatigue life, depending on which one causes loss of bearing service.

Aside from the failure of bearings to function due to natural deterioration, bearings may fail when conditions such as heat-seizure, fracture, scoring of the rings, wear of the seals, or other damage occurs.

Conditions such as these should not be interpreted as normal bearing failure since they often occur as a result of errors in bearing selection, improper design or manufacture of the bearing surroundings, incorrect mounting, or insufficient maintenance.

1.1.1 Rolling Fatigue Life and Rating Fatigue Life

When rolling bearings are operated under load, the raceways of their inner and outer rings and rolling elements are subjected to repeated cyclic stress. Because of metal fatigue of the rolling contact surfaces of the raceways and rolling elements, scaly particles may separate from the bearing material. This phenomenon is called "flaking". Rolling fatigue life is represented by the total number of revolutions at which time the bearing surface will start flaking due to stress. This is called fatigue life.

Even for seemingly identical bearings, which are of the same type, size, and material and receive the same heat treatment and other processing, the rolling fatigue life varies greatly even under identical operating conditions. This is because the flaking of materials due to fatigue is subject to many other variables. Consequently, "rating fatigue life", in which rolling fatigue life is treated as a statistical phenomenon, is used in preference to actual rolling fatigue life.

Suppose a number of bearings of the same type are operated individually under the same conditions. After a certain period of time, 10% of them fail as a result of flaking caused by rolling fatigue. In this case, the total number of revolutions is defined as the rating fatigue life or, if the speed is constant, the rating fatigue life is often expressed by the total number of operating hours completed when 10% of the bearings become inoperable due to flaking.

1.2 Basic Dynamic Load Rating and Fatigue Life

1.2.1 Basic Dynamic Load Rating

The basic dynamic load rating is defined as the constant load applied on bearings with stationary outer rings that the inner rings can endure for a rating life of one million revolutions (10^6 rev). The basic dynamic load rating of radial bearings is defined as a central radial load of constant direction and magnitude, while the basic dynamic load rating of thrust bearings is defined as an axial load of constant magnitude in the same direction as the central axis. The load ratings are listed under C_r for radial bearings and C_a for thrust bearings in the dimension tables.

1.2.2 Selection of Bearing Size Based on Basic Dynamic Load Rating

The following relation exists between bearing load and rating fatigue life:

For ball bearings
$$L = \left(\frac{C}{P}\right)^3 \dots\dots\dots (1.1)$$

For roller bearings
$$L = \left(\frac{C}{P}\right)^{10} \dots\dots\dots (1.2)$$

- where L : Rating fatigue life (10^6 rev)
 P : Bearing load (equivalent load) (N), {kgf}
 (Refer to Page A11)
 C : Basic dynamic load rating (N), {kgf}
 For radial bearings, C is written C_r
 For thrust bearings, C is written C_a

In the case of bearings that run at a constant speed, it is convenient to express the fatigue life in terms of hours. In general, the fatigue life of bearings used in automobiles and other vehicles is given in terms of mileage.

By designating the rating fatigue life as L_h (h), bearing speed as n (rpm), fatigue life factor as f_h , and speed factor as f_n , the relations shown in Table 1.1 are obtained:

Table 1.1 Rating Fatigue Life, Fatigue Life Factor and Speed Factor

Life Parameters	Ball Bearings	Roller Bearings
Rating Fatigue Life	$L_h = \frac{10^6}{60n} \left(\frac{C}{P}\right)^3 = 500f_h^3$	$L_h = \frac{10^6}{60n} \left(\frac{C}{P}\right)^{10} = 500f_h^{10}$
Fatigue Life Factor	$f_h = f_n \frac{C}{P}$	$f_h = f_n \frac{C}{P}$
Speed Factor	$f_n = \left(\frac{10^6}{500 \times 60n}\right)^{\frac{1}{3}}$ $= (0.03n)^{-\frac{1}{3}}$	$f_n = \left(\frac{10^6}{500 \times 60n}\right)^{\frac{3}{10}}$ $= (0.03n)^{-\frac{3}{10}}$

n, f_n Fig. 1.1, Appendix Table 12 (See Page C50)

L_h, f_h Fig. 1.2, Appendix Table 13 (See Page C51)

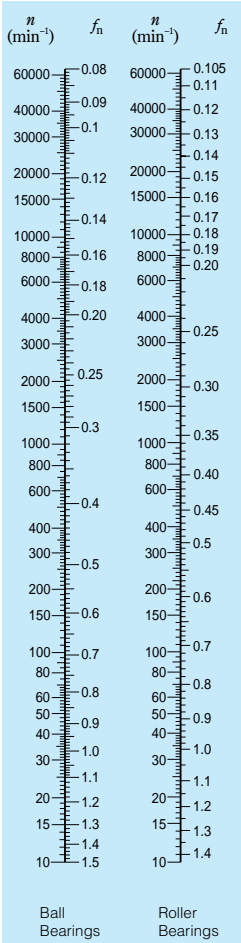

Fig. 1.1 Bearing Speed and Speed Factor

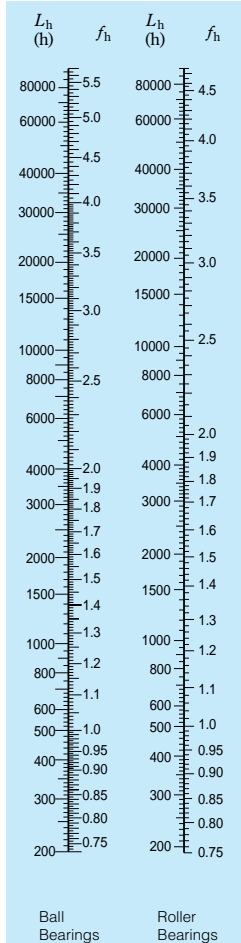

Fig. 1.2 Fatigue Life Factor and Fatigue Life

If the bearing load P and speed n are known, determine a fatigue life factor f_h appropriate for the projected life of the machine and then calculate the basic dynamic load rating C by means of the following equation.

$$C = \frac{f_h \cdot P}{f_n} \dots\dots\dots (1.3)$$

A bearing which satisfies this value of C should then be selected from the bearing tables.

1.2.3 Temperature Adjustment for Basic Dynamic Load Rating

If rolling bearings are used at high temperature, the hardness of the bearing steel decreases. Consequently, the basic dynamic load rating, which depends on the physical properties of the material, also decreases. Therefore, the basic dynamic load rating should be adjusted for the higher temperature using the following equation:

$$C_t = f_t \cdot C \dots\dots\dots (1.4)$$

where C_t : Basic dynamic load rating after temperature adjustment (N), {kgf}
 f_t : Temperature factor (See Table 1.2.)
 C : Basic dynamic load rating before temperature adjustment (N), {kgf}

If large bearings are used at high temperatures, they must be given special dimensional stability heat treatment to prevent excessive dimensional changes. The basic dynamic load rating of bearings given such special dimensional stability heat treatment may become lower than the basic dynamic load rating listed in the bearing tables.

Table 1.2 Temperature Factor f_t

Bearing Temperature °C	125	150	175	200	250
Temperature Factor f_t	1.00	1.00	0.95	0.90	0.75

1.2.4 Adjustment of Rating Fatigue Life

As described previously, the basic equations for calculating the rating fatigue life are as follows:

For ball bearings $L_{10} = \left(\frac{C}{P}\right)^3 \dots\dots\dots (1.5)$

For roller bearings $L_{10} = \left(\frac{C}{P}\right)^{\frac{10}{3}} \dots\dots\dots (1.6)$

The L_{10} life is defined as the rating fatigue life with a statistical reliability of 90%. Depending on the machines in which the bearings are used, sometimes a reliability higher than 90% may be required.

However, recent improvements in bearing material have greatly extended the fatigue life. In addition, the development of the Elasto-Hydrodynamic Theory of Lubrication proves that the thickness of the lubricating film in the contact zone between rings and rolling elements greatly influences bearing life. To reflect such improvements in the calculation of fatigue life, the rating fatigue life is adjusted using the following adjustment factors:

$L_{na} = a_1 a_2 a_3 L_{10} \dots\dots\dots (1.7)$

- where L_{na} : Adjusted rating life in which reliability, material improvements, lubricating condition, etc. are considered
 L_{10} : Rating fatigue life with a reliability of 90%
 a_1 : Life adjustment factor for reliability
 a_2 : Life adjustment factor for special bearing property
 a_3 : Life adjustment factor for operating conditions

The life adjustment factor for reliability a_1 is listed in Table 1.3 for reliabilities higher than 90%.

The life adjustment factor for special bearing property a_2 is greater than one because of improvements in bearing steel. **NSK** now uses vacuum degassed bearing steel, and the results of tests by **NSK** show that life is greatly improved when compared with earlier materials. The basic dynamic load ratings C_r and C_a listed in the bearing tables were calculated considering the extended life achieved by improvements in materials and manufacturing techniques. Consequently, when estimating life using Equation (1.7), it is sufficient to assume $a_2=1$.

The life adjustment factor for operating conditions a_3 is used to adjust for various factors, particularly lubrication. If there is no misalignment between the inner and outer rings and the thickness of the lubricating film in the contact zones of the bearing is sufficient, it is possible for a_3 to be greater than one; however, a_3 is less than one in the following cases:

- When the viscosity of the lubricant in the contact zones between the raceways and rolling elements is low.
- When the circumferential speed of the rolling elements is very slow.
- When the bearing temperature is high.
- When the lubricant is contaminated by water or foreign particles.
- When misalignment of the inner and outer rings is excessive.

It is difficult to determine the proper value for a_3 for specific operating conditions because there are still many unknowns. Since the special bearing property factor a_2 is also influenced by the operating conditions, there is a proposal to combine a_2 and a_3 into one quantity ($a_2 \times a_3$), and not consider them independently. In this case, under normal lubricating and operating conditions, the product ($a_2 \times a_3$) should be assumed equal to one. However, if the viscosity of the lubricant is too low, the value drops to as low as 0.2.

If there is no misalignment and a lubricant with high viscosity is used so sufficient fluid-film thickness is secured, the product of ($a_2 \times a_3$) may be about two.

When selecting a bearing based on the basic dynamic load rating, it is best to choose a reliability factor a_1 appropriate for the projected use and an empirically determined C/P or f_h value derived from past results for lubrication, temperature, mounting conditions, etc. in similar machines.

The rating fatigue life equations (1.1), (1.2), (1.5), and (1.6) give satisfactory results for a broad range of bearing loads. However, extra heavy loads may cause detrimental plastic deformation at ball/raceway contact points. When P_r exceeds C_{0r} (Basic static load rating) or $0.5 C_r$, whichever is smaller, for radial bearings or P_a exceeds $0.5 C_a$ for thrust bearings, please consult **NSK** to establish the applicability of the rating fatigue life equations.

Table 1.3 Reliability Factor a_1

Reliability (%)	90	95	96	97	98	99
a_1	1.00	0.62	0.53	0.44	0.33	0.21

1.3 Calculation of Bearing Loads

The loads applied on bearings generally include the weight of the body to be supported by the bearings, the weight of the revolving elements themselves, the transmission power of gears and belting, the load produced by the operation of the machine in which the bearings are used, etc. These loads can be theoretically calculated, but some of them are difficult to estimate. Therefore, it become necessary to correct the estimates using empirically derived data.

1.3.1 Load Factor

When a radial or axial load has been mathematically calculated, the actual load on the bearing may be greater than the calculated load because of vibration and shock present during operation of the machine. The actual load may be calculated using the following equation:

$$\left. \begin{aligned} F_r &= f_w \cdot F_{rc} \\ F_a &= f_w \cdot F_{ac} \end{aligned} \right\} \dots\dots\dots (1.8)$$

where F_r, F_a : Loads applied on bearing (N), {kgf}

F_{rc}, F_{ac} : Theoretically calculated load (N), {kgf}

f_w : Load factor

The values given in Table 1.4 are usually used for the load factor f_w .

1.3.2 Average of Fluctuating Load

When the load applied on bearings fluctuates, an average load which will yield the same bearing life as the fluctuating load should be calculated.

(1) When the relation between load and rotating speed is divided into the following steps (Fig. 1.3).

Load F_1 : Speed n_1 ; Operating time t_1

Load F_2 : Speed n_2 ; Operating time t_2

⋮ ⋮ ⋮

Load F_n : Speed n_n ; Operating time t_n

Then, the average load F_m may be calculated using the following equation:

$$F_m = \sqrt[p]{\frac{F_1^p n_1 t_1 + F_2^p n_2 t_2 + \dots + F_n^p n_n t_n}{n_1 t_1 + n_2 t_2 + \dots + n_n t_n}} \dots\dots\dots (1.9)$$

where F_m : Average fluctuating load (N), {kgf}

$p=3$ for ball bearings

$p=10/3$ for roller bearings

The average speed n_m may be calculated as follows:

$$n_m = \frac{n_1 t_1 + n_2 t_2 + \dots + n_n t_n}{t_1 + t_2 + \dots + t_n} \dots\dots\dots (1.10)$$

Table 1.4 Values of Load Factor f_w

Operating Conditions	Typical Applications	f_w
Smooth operation free from shock	Electric motors, Machine tools, Air conditioners	1 to 1.2
Normal operation	Air blowers, Compressors, Elevators, Cranes, Paper making machines	1.2 to 1.5
Operation accompanied by shock and vibration	Construction equipment, Crushers, Vibrating screens, Rolling mills	1.5 to 3

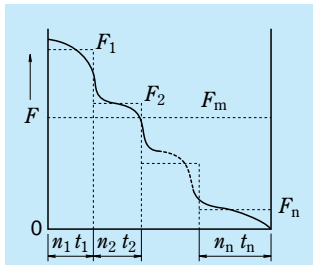

Fig. 1.3 Incremental Load Variation

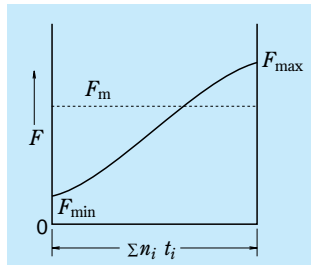

Fig. 1.4 Simple Load Fluctuation

(2) When the load fluctuates almost linearly (Fig. 1.4), the average load may be calculated as follows:

$$F_m = \frac{1}{3} (F_{\min} + 2F_{\max}) \dots\dots\dots(1.11)$$

where F_{\min} : Minimum value of fluctuating load (N), {kgf}

F_{\max} : Maximum value of fluctuating load (N), {kgf}

(3) When the load fluctuation is similar to a sine wave (Fig. 1.5), an approximate value for the average load F_m may be calculated from the following equation:

In the case of Fig. 1.5(a)

$$F_m \doteq 0.65 F_{\max} \dots\dots\dots(1.12)$$

In the case of Fig. 1.5(b)

$$F_m \doteq 0.75 F_{\max} \dots\dots\dots(1.13)$$

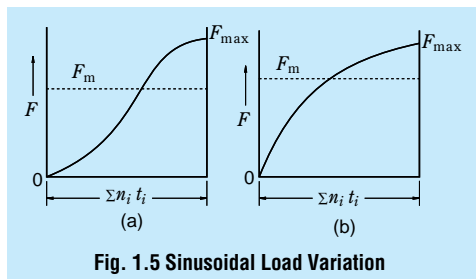

Fig. 1.5 Sinusoidal Load Variation

1.4 Dynamic Equivalent Load

In some cases, the loads applied on bearings are purely radial or axial loads; however, in most cases, the loads are a combination of both. In addition, such loads usually fluctuate in both magnitude and direction. In such cases, the loads actually applied on bearings cannot be used for bearing life calculations; therefore, a hypothetical load that has a constant magnitude and passes through the center of the bearing, and will give the same bearing life that the bearing would attain under actual conditions of load and rotation should be estimated. Such a hypothetical load is called the dynamic equivalent load.

1.4.1 Calculation of Dynamic Equivalent Loads

The dynamic equivalent load on radial bearings may be calculated using the following equation:

$$P = X F_r + Y F_a \dots\dots\dots(1.14)$$

where P : Dynamic equivalent load (N), {kgf}

F_r : Radial load (N), {kgf}

F_a : Axial load (N), {kgf}

X : Radial load factor

Y : Axial load factor

The values of X and Y are listed in the bearing tables. The equivalent radial load for radial roller bearings with $\alpha=0^\circ$ is

$$P = F_r$$

In general, thrust ball bearings cannot take radial loads, but spherical thrust roller bearings can take some radial loads. In this case, the dynamic equivalent load may be calculated using the following equation:

$$P = F_a + 1.2 F_r \dots\dots\dots(1.15)$$

where $\frac{F_r}{F_a} \leq 0.55$

1.5 Basic Static Load Ratings and Static Equivalent Loads

1.5.1 Basic Static Load Ratings

When subjected to an excessive load or a strong shock load, rolling bearings may incur a local permanent deformation of the rolling elements and raceway surface if the elastic limit is exceeded. The nonelastic deformation increases in area and depth as the load increases, and when the load exceeds a certain limit, the smooth running of the bearing is impeded.

The basic static load rating is defined as that static load which produces the following calculated contact stress at the center of the contact area between the rolling element subjected to the maximum stress and the raceway surface.

For ball bearings $4\ 200\text{MPa}$
 $\{428\text{kgf/mm}^2\}$

For roller bearings $4\ 000\text{MPa}$
 $\{408\text{kgf/mm}^2\}$

In this most heavily stressed contact area, the sum of the permanent deformation of the rolling element and that of the raceway is nearly 0.0001 times the rolling element's diameter. The basic static load rating C_0 is written C_{0r} for radial bearings and C_{0a} for thrust bearings in the bearing tables.

In addition, following the modification of the criteria for basic static load rating by ISO, the new C_0 values for NSK's ball bearings became about 0.8 to 1.3 times the past values and those for roller bearings about 1.5 to 1.9 times. Consequently, the values of permissible static load factor f_s have also changed, so please pay attention to this.

1.5.2 Static Equivalent Loads

The static equivalent load is a hypothetical load that produces a contact stress equal to the above maximum stress under actual conditions, while the bearing is stationary (including very slow rotation or oscillation), in the area of contact between the most heavily stressed rolling element and bearing raceway. The static radial load passing through the bearing center is taken as the static equivalent load for radial bearings, while the static axial load in the direction coinciding with the central axis is taken as the static equivalent load for thrust bearings.

(a) Static equivalent load on radial bearings

The greater of the two values calculated from the following equations should be adopted as the static equivalent load on radial bearings.

$$P_0 = X_0 F_r + Y_0 F_a \dots\dots\dots (1.16)$$

$$P_0 = F_r \dots\dots\dots (1.17)$$

where P_0 : Static equivalent load (N), {kgf}
 F_r : Radial load (N), {kgf}
 F_a : Axial load (N), {kgf}
 X_0 : Static radial load factor
 Y_0 : Static axial load factor

(b) Static equivalent load on thrust bearings

$$P_0 = X_0 F_r + F_a \quad \alpha \neq 90^\circ \dots\dots\dots (1.18)$$

where P_0 : Static equivalent load (N), {kgf}
 α : Contact angle

When $F_a < X_0 F_r$, this equation becomes less accurate. The values of X_0 and Y_0 for Equations (1.16) and (1.18) are listed in the bearing tables.

The static equivalent load for thrust roller bearings with $\alpha = 90^\circ$ is

$$P_0 = F_a$$

1.5.3 Permissible Static Load Factor

The permissible static equivalent load on bearings varies depending on the basic static load rating and also their application and operating conditions.

The permissible static load factor f_s is a safety factor that is applied to the basic static load rating, and it is defined by the ratio in Equation (1.19). The generally recommended values of f_s are listed in Table 1.5. Conforming to the modification of the static load rating, the values of f_s were revised, especially for bearings for which the values of C_0 were increased, please keep this in mind when selecting bearings.

$$f_s = \frac{C_0}{P_0} \dots\dots\dots (1.19)$$

where C_0 : Basic static load rating (N), {kgf}
 P_0 : Static equivalent load (N), {kgf}

For spherical thrust roller bearings, the value of f_s should be greater than 4.

Table 1.5 Values of Permissible Static Load Factor f_s

Operating Conditions	Lower Limit of f_s	
	Ball Bearings	Roller Bearings
Low-noise applications	2	3
Bearings subjected to vibration and shock loads	1.5	2
Standard operating conditions	1	1.5

2. BEARING TOLERANCES

2.1 Bearing Tolerance Standards

The tolerances for the boundary dimensions and running accuracy of rolling bearings are specified by ISO 492/199/582 (Accuracies of Rolling Bearings). Tolerances are specified for the following items:

Regarding bearing accuracy classes, besides ISO normal accuracy, as the accuracy improves there are Class 6X (for tapered roller bearings), Class 6, Class 5, and Class 4. The applicable accuracy classes for each bearing type and the correspondence of these classes are shown in Table 2.1.

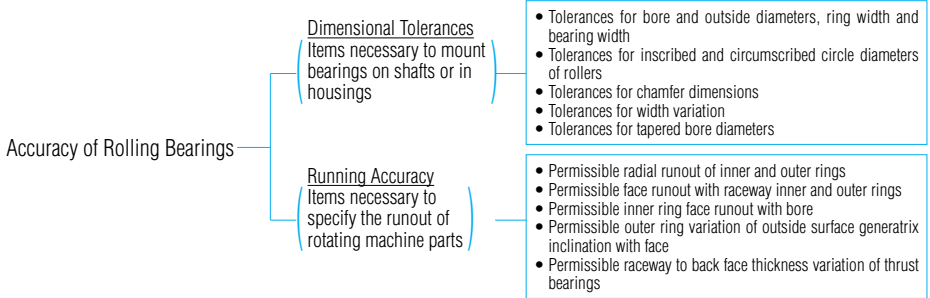

Table 2.1 Bearing Types and Tolerance Classes

Bearing Types		Applicable Tolerance Classes				Applicable Tables	Reference Pages	
Deep Groove Ball Bearings		Normal	Class 6	Class 5	Class 4	Table 2.2	A16 to A19	
Angular Contact Ball Bearings		Normal	Class 6	Class 5	Class 4			
Cylindrical Roller Bearings		Normal	Class 6	Class 5	Class 4			
Spherical Roller Bearings		Normal	Class 6 equivalent	Class 5 equivalent	—			
Tapered Roller Bearings	Metric Design	Normal Class 6X	—	Class 5	Class 4	Table 2.3	A20 to A23	
	Inch Design	ABMA CLASS 4	ABMA CLASS 2	ABMA CLASS 3	ABMA CLASS 0	Table 2.4	A24 to A25	
Thrust Ball Bearings		Normal	Class 6	Class 5	Class 4	Table 2.5	A26 to A27	
Tapered Roller Thrust Bearings		Normal	—	—	—	Table 2.6	A28	
Spherical Thrust Roller Bearings		Normal	—	—	—	Table 2.7	A29	
Equivalent standards (Reference)	JIS ⁽¹⁾		Class 0	Class 6	Class 5	Class 4	—	—
	DIN ⁽²⁾		P 0	P 6	P 5	P 4	—	—
	ANSI/ABMA ⁽³⁾	Ball Bearings	ABEC 1	ABEC 3	ABEC 5	ABEC 7	Table 2.2	A16 to A19
		Roller Bearings	RBEC 1	RBEC 3	RBEC 5	—		
	Tapered Roller Bearings	CLASS 4	CLASS 2	CLASS 3	CLASS 0	(Table 2.4)	(A24 to A25)	

Notes ⁽¹⁾ JIS : Japanese Industrial Standards ⁽²⁾ DIN : Deutch Industrie Norm

⁽³⁾ ANSI/ABMA : The American Bearing Manufactures Association

Remarks The permissible limit of chamfer dimensions shall conform to Table 2.7 (Page A29), and the tolerances and permissible tapered bore diameters shall conform to Table 2.9 (Page A32).

(Reference) Rough definitions of the items listed for Running Accuracy and their measuring methods are shown in Fig. 2.1, and they are described in detail in ISO 5593 (Rolling Bearings-Vocabulary) and JIS B 1515 (Rolling Bearings-Tolerances) and elsewhere.

Supplementary Table

Running Accuracy	Inner Ring	Outer Ring	Dial Gauge
K_{ia}	Rotating	Stationary	A
K_{ea}	Stationary	Rotating	A
S_{ia}	Rotating	Stationary	B_1
S_{ea}	Stationary	Rotating	B_2
S_d	Rotating	Stationary	C
S_D	–	Rotating	D
S_i, S_e	Only the shaft or housing or central washer is to be rotated.		E

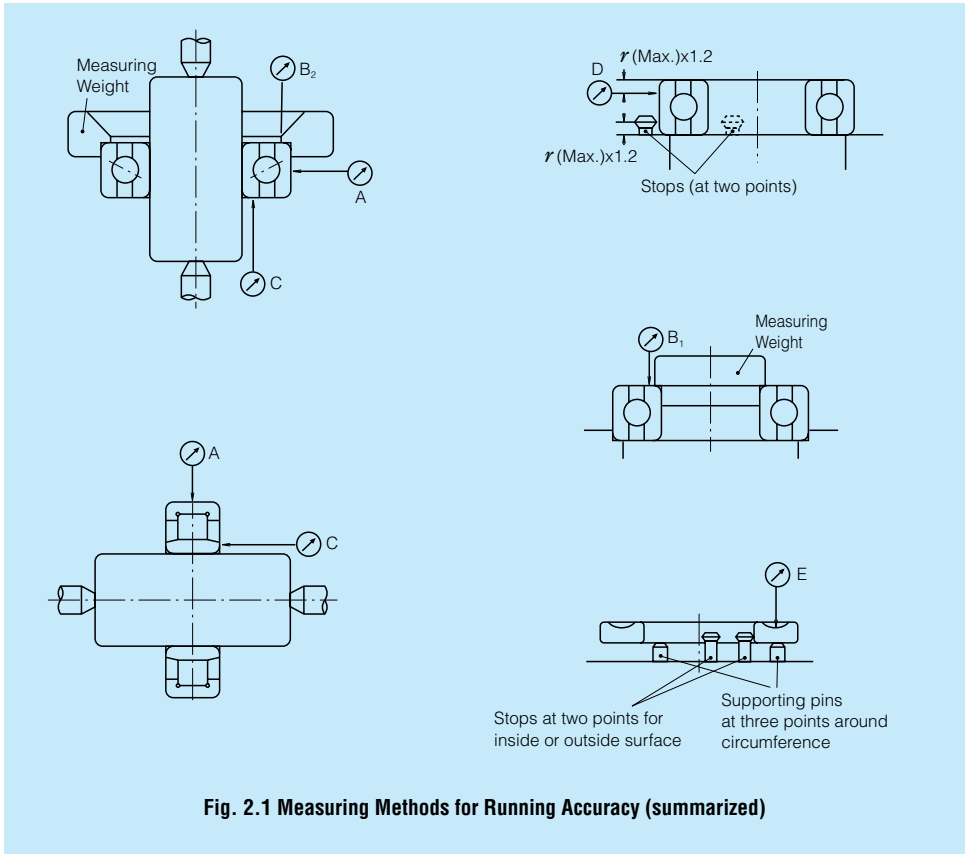

Fig. 2.1 Measuring Methods for Running Accuracy (summarized)

Symbols for Boundary Dimensions and Running Accuracy

d	Nominal bore diameter	D	Nominal outside diameter
Δd_s	Deviation of a single bore diameter	ΔD_s	Deviation of a single outside diameter
Δd_{mp}	Single plane mean bore diameter deviation	ΔD_{mp}	Single plane mean outside diameter deviation
V_{dp}	Bore diameter variation in a single radial plane	V_{Dp}	Outside diameter variation in a single radial plane
V_{dmp}	Mean bore diameter variation	V_{Dmp}	Mean outside diameter variation
B	Nominal inner ring width	C	Nominal outer ring width
ΔB_s	Deviation of a single inner ring width	ΔC_s	Deviation of a single outer ring width
V_{Bs}	Inner ring width variation	V_{Cs}	Outer ring width variation
K_{ia}	Radial runout of assembled bearing inner ring	K_{ea}	Radial runout of assembled bearing outer ring
S_d	Inner ring reference face (back face, where applicable) runout with bore	S_D	Variation of bearing outside surface generatrix inclination with outer ring reference face (back face)
S_{ia}	Assembled bearing inner ring face (back face) runout with raceway	S_{ea}	Assembled bearing outer ring face (back face) runout with raceway
S_i, S_e	Raceway to back face thickness variation of thrust bearing		
T	Nominal bearing width		
ΔT_s	Deviation of the actual bearing width		

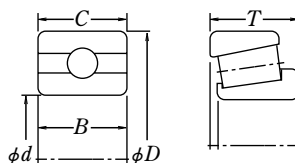

Table 2.2 Tolerances for Radial Bearings
Table 2.2.1 Tolerances for Inner Rings and

Nominal Bore Diameter <i>d</i> (mm)		$\Delta d_{mp} \text{ (}^1\text{)}$								$\Delta d_s \text{ (}^1\text{)}$	
		Normal		Class 6		Class 5		Class 4		Class 4	
										Diameter Series	
over	incl	high	low	high	low	high	low	high	low	0, 1, 2, 3, 4	
80	120	0	-20	0	-15	0	-10	0	-8	0	-8
120	150	0	-25	0	-18	0	-13	0	-10	0	-10
150	180	0	-25	0	-18	0	-13	0	-10	0	-10
180	250	0	-30	0	-22	0	-15	0	-12	0	-12
250	315	0	-35	0	-25	0	-18	—	—	—	—
315	400	0	-40	0	-30	0	-23	—	—	—	—
400	500	0	-45	0	-35	—	—	—	—	—	—
500	630	0	-50	0	-40	—	—	—	—	—	—
630	800	0	-75	—	—	—	—	—	—	—	—
800	1 000	0	-100	—	—	—	—	—	—	—	—
1 000	1 250	0	-125	—	—	—	—	—	—	—	—
1 250	1 600	0	-160	—	—	—	—	—	—	—	—
1 600	2 000	0	-200	—	—	—	—	—	—	—	—

		$\Delta B_s \text{ (or } \Delta C_s \text{) (}^2\text{)}$						$V_{Bs} \text{ (or } V_{Cs} \text{)}$					
		Single Bearing				Combined Bearings (}^3\text{)}				Inner Ring (or Outer Ring) (}^4\text{)}		Inner Ring	
		Normal Class 6		Class 5 Class 4		Normal Class 6		Class 5 Class 4		Normal	Class 6	Class 5	Class 4
high	low	high	low	high	low	high	low	max.	max.	max.	max.		
0	-200	0	-200	0	-380	0	-380	25	25	7	4		
0	-250	0	-250	0	-500	0	-380	30	30	8	5		
0	-250	0	-250	0	-500	0	-380	30	30	8	5		
0	-300	0	-300	0	-500	0	-500	30	30	10	6		
0	-350	0	-350	0	-500	0	-500	35	35	13	—		
0	-400	0	-400	0	-630	0	-630	40	40	15	—		
0	-450	—	—	—	—	—	—	50	45	—	—		
0	-500	—	—	—	—	—	—	60	50	—	—		
0	-750	—	—	—	—	—	—	70	—	—	—		
0	-1 000	—	—	—	—	—	—	80	—	—	—		
0	-1 250	—	—	—	—	—	—	100	—	—	—		
0	-1 600	—	—	—	—	—	—	120	—	—	—		
0	-2 000	—	—	—	—	—	—	140	—	—	—		

- Notes** (1) Applicable to bearings with cylindrical bores.
 (2) Tolerance for width deviation and tolerance limits for the width variation of the outer ring should be the same bearing. Tolerances for the width variation of the outer ring of Classes 5 and 4, are shown in Table 2.2.2.
 (3) Applicable to individual rings manufactured for combined bearings.
 (4) Applicable to ball bearings such as deep groove ball bearings, angular contact ball bearings, etc.

(Excluding Tapered Roller Bearings)

Widths of Outer Rings

$V_{dp} (^{\circ})$										$V_{dmp} (^{\circ})$			
Normal			Class 6			Class 5		Class 4		Normal	Class 6	Class 5	Class 4
Diameter Series			Diameter Series			Diameter Series		Diameter Series					
9	0, 1	2, 3, 4	9	0, 1	2, 3, 4	9	0,1,2,3,4	9	0,1,2,3,4				
max.			max.			max.		max.		max.	max.	max.	max.
25	25	15	19	19	11	10	8	8	6	15	11	5	4
31	31	19	23	23	14	13	10	10	8	19	14	7	5
31	31	19	23	23	14	13	10	10	8	19	14	7	5
38	38	23	28	28	17	15	12	12	9	23	17	8	6
44	44	26	31	31	19	18	14	—	—	26	19	9	—
50	50	30	38	38	23	23	18	—	—	30	23	12	—
56	56	34	44	44	26	—	—	—	—	34	26	—	—
63	63	38	50	50	30	—	—	—	—	38	30	—	—
—	—	—	—	—	—	—	—	—	—	—	—	—	—
—	—	—	—	—	—	—	—	—	—	—	—	—	—
—	—	—	—	—	—	—	—	—	—	—	—	—	—
—	—	—	—	—	—	—	—	—	—	—	—	—	—

Units:μm

K_{ia}				S_d		$S_{ia} (^{\circ})$		Nominal Bore Diameter d (mm)	
Normal	Class 6	Class 5	Class 4	Class 5	Class 4	Class 5	Class 4	over	incl
max.	max.	max.	max.	max.	max.	max.	max.		
25	13	6	5	9	5	9	5	80	120
30	18	8	6	10	6	10	7	120	150
30	18	8	6	10	6	10	7	150	180
40	20	10	8	11	7	13	8	180	250
50	25	13	—	13	—	15	—	250	315
60	30	15	—	15	—	20	—	315	400
65	35	—	—	—	—	—	—	400	500
70	40	—	—	—	—	—	—	500	630
80	—	—	—	—	—	—	—	630	800
90	—	—	—	—	—	—	—	800	1 000
100	—	—	—	—	—	—	—	1 000	1 250
120	—	—	—	—	—	—	—	1 250	1 600
140	—	—	—	—	—	—	—	1 600	2 000

- Remarks**
- The cylindrical bore diameter “no-go side” tolerance limit (high) specified in this table does not necessarily apply within a distance of 1.2 times the chamfer dimension r (max.) from the ring face.
 - ANSI/ABMA Std 20-1996 : ABEC1 • RBEC1, ABEC3 • RBEC3, ABEC5 • RBEC5, and ABEC7 • RBEC7 are equivalent to Classes Normal, 6, 5, and 4 respectively.

Table 2. 2 Tolerances for Radial Bearings

Table 2. 2. 2 Tolerances

Nominal Outside Diameter <i>D</i> (mm)		ΔD_{mp}								ΔD_s	
		Normal		Class 6		Class 5		Class 4		Class 4	
										Diameter Series	
		0, 1, 2, 3, 4									
over	incl	high	low	high	low	high	low	high	low	high	low
80	120	0	-15	0	-13	0	-10	0	-8	0	-8
120	150	0	-18	0	-15	0	-11	0	-9	0	-9
150	180	0	-25	0	-18	0	-13	0	-10	0	-10
180	250	0	-30	0	-20	0	-15	0	-11	0	-11
250	315	0	-35	0	-25	0	-18	0	-13	0	-13
315	400	0	-40	0	-28	0	-20	0	-15	0	-15
400	500	0	-45	0	-33	0	-23	—	—	—	—
500	630	0	-50	0	-38	0	-28	—	—	—	—
630	800	0	-75	0	-45	0	-35	—	—	—	—
800	1 000	0	-100	0	-60	—	—	—	—	—	—
1 000	1 250	0	-125	—	—	—	—	—	—	—	—
1 250	1 600	0	-160	—	—	—	—	—	—	—	—
1 600	2 000	0	-200	—	—	—	—	—	—	—	—
2 000	2 500	0	-250	—	—	—	—	—	—	—	—

- Notes** (1) Applicable only when a locating snap ring is not used.
 (2) Applicable to ball bearings such as deep groove ball bearings and angular contact ball bearings.
 (3) The tolerances for outer ring width variation of bearings of Classes Normal and 6 are shown in Table 2.2.1.

- Remarks** 1. The outside diameter “no-go side” tolerances (low) specified in this table do not necessarily apply within a distance of 1.2 times the chamfer dimension r (max.) from the ring face.
 2. ANSI/ABMA Std 20-1996 : ABEC1 • RBEC1, ABEC3 • RBEC3, ABEC5 • RBEC5, and ABEC7 • RBEC7 are equivalent to Classes Normal, 6, 5, and 4 respectively.

**(Excluding Tapered Roller Bearings)
for Outer Rings**

$V_{Dp} (^{\circ})$												$V_{Dmp} (^{\circ})$			
Normal				Class 6				Class 5		Class 4		Normal	Class 6	Class 5	Class 4
Open Type			Shielded Sealed	Open Type			Shielded Sealed	Open Type		Open Type					
Diameter Series				Diameter Series				Diameter Series		Diameter Series					
9	0, 1	2, 3, 4	2, 3, 4	9	0, 1	2, 3, 4	0,1,2,3,4	9	0,1,2,3,4	9	0,1,2,3,4				
max.				max.				max.		max.		max.	max.	max.	max.
19	19	11	26	16	16	10	20	10	8	8	6	11	10	5	4
23	23	14	30	19	19	11	25	11	8	9	7	14	11	6	5
31	31	19	38	23	23	14	30	13	10	10	8	19	14	7	5
38	38	23	—	25	25	15	—	15	11	11	8	23	15	8	6
44	44	26	—	31	31	19	—	18	14	13	10	26	19	9	7
50	50	30	—	35	35	21	—	20	15	15	11	30	21	10	8
56	56	34	—	41	41	25	—	23	17	—	—	34	25	12	—
63	63	38	—	48	48	29	—	28	21	—	—	38	29	14	—
94	94	55	—	56	56	34	—	35	26	—	—	55	34	18	—
125	125	75	—	75	75	45	—	—	—	—	—	75	45	—	—
—	—	—	—	—	—	—	—	—	—	—	—	—	—	—	—
—	—	—	—	—	—	—	—	—	—	—	—	—	—	—	—
—	—	—	—	—	—	—	—	—	—	—	—	—	—	—	—

Units:µm

K_{ea}				S_D		$S_{ea} (^{\circ})$		$V_{Cs} (^{\circ})$		Nominal Outside Diameter D (mm)	
Normal	Class 6	Class 5	Class 4	Class 5	Class 4	Class 5	Class 4	Class 5	Class 4		
max.	max.	max.	max.	max.	max.	max.	max.	max.	max.		
35	18	10	6	9	5	11	6	8	4	80	120
40	20	11	7	10	5	13	7	8	5	120	150
45	23	13	8	10	5	14	8	8	5	150	180
50	25	15	10	11	7	15	10	10	7	180	250
60	30	18	11	13	8	18	10	11	7	250	315
70	35	20	13	13	10	20	13	13	8	315	400
80	40	23	—	15	—	23	—	15	—	400	500
100	50	25	—	18	—	25	—	18	—	500	630
120	60	30	—	20	—	30	—	20	—	630	800
140	75	—	—	—	—	—	—	—	—	800	1 000
160	—	—	—	—	—	—	—	—	—	1 000	1 250
190	—	—	—	—	—	—	—	—	—	1 250	1 600
220	—	—	—	—	—	—	—	—	—	1 600	2 000
250	—	—	—	—	—	—	—	—	—	2 000	2 500

Table 2. 3 Tolerances for Metric Design
Table 2. 3. 1 Tolerances for Inner Ring Bore Diameter

Nominal Bore Diameter <i>d</i> (mm)		Δd_{mp}						Δd_s		V_{dp}				V_{dmp}			
		Normal Class 6X		Class 6 Class 5		Class 4		Class 4		Normal Class 6X	Class 6	Class 5	Class 4	Normal Class 6X	Class 6	Class 5	Class 4
over	incl	high	low	high	low	high	low	high	low	max.	max.	max.	max.	max.	max.	max.	max.
80	120	0	-20	0	-15	0	-10	0	-10	20	15	11	8	15	11	8	5
120	180	0	-25	0	-18	0	-13	0	-13	25	18	14	10	19	14	9	7
180	250	0	-30	0	-22	0	-15	0	-15	30	22	17	11	23	16	11	8
250	315	0	-35	0	-25	0	-18	0	-18	35	—	—	—	26	—	—	—
315	400	0	-40	0	-30	0	-23	0	-23	40	—	—	—	30	—	—	—
400	500	0	-45	0	-35	0	-27	0	-27	—	—	—	—	—	—	—	—
500	630	0	-50	0	-40	—	—	—	—	—	—	—	—	—	—	—	—
630	800	0	-75	0	-60	—	—	—	—	—	—	—	—	—	—	—	—
800	1 000	0	-100	0	-75	—	—	—	—	—	—	—	—	—	—	—	—
1 000	1 250	0	-125	0	-95	—	—	—	—	—	—	—	—	—	—	—	—
1 250	1 600	0	-160	0	-120	—	—	—	—	—	—	—	—	—	—	—	—
1 600	2 000	0	-200	0	-150	—	—	—	—	—	—	—	—	—	—	—	—

- Remarks**
1. The bore diameter "no-go side" tolerances (high) specified in this table do not necessarily apply within a distance of 1.2 times the chamfer dimension *r* (max.) from the ring face.
 2. Some of these tolerances conform to the NSK Standard.

Table 2. 3. 2 Tolerances for Outer Ring Outside Diameter

Nominal Outside Diameter <i>D</i> (mm)		ΔD_{mp}						ΔD_s		V_{Dp}				V_{Dmp}			
		Normal Class 6X		Class 6 Class 5		Class 4		Class 4		Normal Class 6X	Class 6	Class 5	Class 4	Normal Class 6X	Class 6	Class 5	Class 4
over	incl	high	low	high	low	high	low	high	low	max.	max.	max.	max.	max.	max.	max.	max.
80	120	0	-15	0	-13	0	-10	0	-10	15	13	10	8	11	10	7	5
120	150	0	-18	0	-15	0	-11	0	-11	18	15	11	8	14	11	8	6
150	180	0	-25	0	-18	0	-13	0	-13	25	18	14	10	19	14	9	7
180	250	0	-30	0	-20	0	-15	0	-15	30	20	15	11	23	15	10	8
250	315	0	-35	0	-25	0	-18	0	-18	35	25	19	14	26	19	13	9
315	400	0	-40	0	-28	0	-20	0	-20	40	28	22	15	30	21	14	10
400	500	0	-45	0	-33	0	-23	0	-23	45	—	—	—	34	—	—	—
500	630	0	-50	0	-38	0	-28	0	-28	50	—	—	—	38	—	—	—
630	800	0	-75	0	-45	—	—	—	—	—	—	—	—	—	—	—	—
800	1 000	0	-100	0	-60	—	—	—	—	—	—	—	—	—	—	—	—
1 000	1 250	0	-125	0	-75	—	—	—	—	—	—	—	—	—	—	—	—
1 250	1 600	0	-160	0	-95	—	—	—	—	—	—	—	—	—	—	—	—
1 600	2 000	0	-200	0	-120	—	—	—	—	—	—	—	—	—	—	—	—
2 000	2 500	0	-250	0	-150	—	—	—	—	—	—	—	—	—	—	—	—

- Remarks**
1. The outside diameter "no-go side" tolerances (low) specified in this table do not necessarily apply within a distance of 1.2 times the chamfer dimension *r* (max.) from the ring face.
 2. Some of these tolerances conform to the NSK Standard.

**Tapered Roller Bearings
and Running Accuracy**

Units: μm

K_{ia}				S_d		S_{ia}
Normal Class 6X	Class 6	Class 5	Class 4	Class 5	Class 4	Class 4
max.	max.	max.	max.	max.	max.	max.
30	13	6	5	9	5	5
35	18	8	6	10	6	7
50	20	10	8	11	7	8
60	25	13	10	13	8	10
70	30	15	12	15	10	14
70	35	18	14	19	13	17
85	40	20	—	22	—	—
100	45	22	—	27	—	—
120	50	25	—	35	—	—
140	55	—	—	—	—	—
170	60	—	—	—	—	—
210	70	—	—	—	—	—

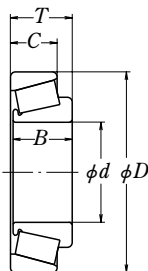

and Running Accuracy

Units: μm

K_{ea}				S_D		S_{ea}
Normal Class 6X	Class 6	Class 5	Class 4	Class 5	Class 4	Class 4
max.	max.	max.	max.	max.	max.	max.
35	18	10	6	9	5	6
40	20	11	7	10	5	7
45	23	13	8	10	5	8
50	25	15	10	11	7	10
60	30	18	11	13	8	10
70	35	20	13	13	10	13
80	40	23	15	15	11	15
100	50	25	18	18	13	18
120	60	30	—	20	—	—
120	75	35	—	23	—	—
120	85	40	—	27	—	—
120	95	—	—	—	—	—
120	115	—	—	—	—	—
160	130	—	—	—	—	—

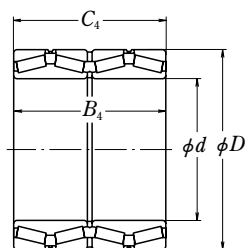
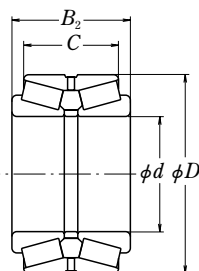
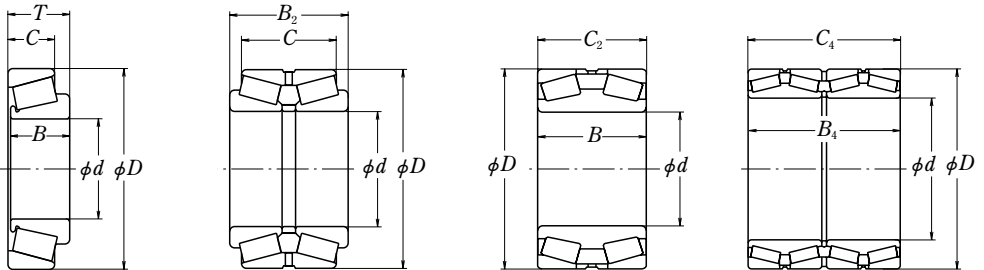

Table 2. 3 Tolerances for Metric Design
Table 2. 3. 3 Tolerances for Width, Overall Bearing Width,

Nominal Bore Diameter d (mm)		Δ_{Bs}						Δ_{Cs}						Δ_{Ts}					
		Normal Class 6		Class 6X		Class 5 Class 4		Normal Class 6		Class 6X		Class 5 Class 4		Normal Class 6		Class 6X		Class 5 Class 4	
over	incl	high	low	high	low	high	low	high	low	high	low	high	low	high	low	high	low	high	low
80	120	0	-200	0	-50	0	-400	0	-200	0	-100	0	-400	+200	-200	+100	0	+200	-200
120	180	0	-250	0	-50	0	-500	0	-250	0	-100	0	-500	+350	-250	+150	0	+350	-250
180	250	0	-300	0	-50	0	-600	0	-300	0	-100	0	-600	+350	-250	+150	0	+350	-250
250	315	0	-350	0	-50	0	-700	0	-350	0	-100	0	-700	+350	-250	+200	0	+350	-250
315	400	0	-400	0	-50	0	-800	0	-400	0	-100	0	-800	+400	-400	+200	0	+400	-400
400	500	0	-450	—	—	0	-800	0	-450	—	—	0	-800	+400	-400	—	—	+400	-400
500	630	0	-500	—	—	0	-800	0	-500	—	—	0	-800	+500	-500	—	—	+500	-500
630	800	0	-750	—	—	0	-800	0	-750	—	—	0	-800	+600	-600	—	—	+600	-600
800	1 000	0	-1 000	—	—	0	-1 000	0	-1 000	—	—	0	-1 000	+750	-750	—	—	+750	-750
1 000	1 250	0	-1 250	—	—	0	-1 250	0	-1 250	—	—	0	-1 250	+1 000	-1 000	—	—	+1 000	-1 000
1 250	1 600	0	-1 600	—	—	0	-1 600	0	-1 600	—	—	0	-1 600	+1 250	-1 250	—	—	+1 250	-1 250
1 600	2 000	0	-2 000	—	—	0	-2 000	0	-2 000	—	—	0	-2 000	+1 500	-1 500	—	—	+1 500	-1 500

Remarks The effective width of an inner ring with rollers T_1 is defined as the overall bearing width of an inner ring with rollers combined with a master outer ring.
 The effective width of an outer ring T_2 is defined as the overall bearing width of an outer ring combined with a master inner ring with rollers.



**Tapered Roller Bearings
and Combined Bearing Width**

Units: μm

Ring Width with Rollers Deviation ΔT_{1S}				Outer Ring Effective Width Deviation ΔT_{2S}				Overall Combined Bearing Width Deviation ΔB_{2S}				Nominal Bore Diameter d (mm)	
Normal		Class 6X		Normal		Class 6X		All classes of double-row bearings		All classes of four-row bearings			
high	low	high	low	high	low	high	low	high	low	high	low	over	incl
+ 100	- 100	+ 50	0	+ 100	- 100	+ 50	0	+ 300	- 300	+ 400	- 400	80	120
+ 150	- 150	+ 50	0	+ 200	- 100	+ 100	0	+ 400	- 400	+ 500	- 500	120	180
+ 150	- 150	+ 50	0	+ 200	- 100	+ 100	0	+ 450	- 450	+ 600	- 600	180	250
+ 150	- 150	+ 100	0	+ 200	- 100	+ 100	0	+ 550	- 550	+ 700	- 700	250	315
+ 200	- 200	+ 100	0	+ 200	- 200	+ 100	0	+ 600	- 600	+ 800	- 800	315	400
—	—	—	—	—	—	—	—	+ 700	- 700	+ 900	- 900	400	500
—	—	—	—	—	—	—	—	+ 800	- 800	+ 1 000	- 1 000	500	630
—	—	—	—	—	—	—	—	+ 1 200	- 1 200	+ 1 500	- 1 500	630	800
—	—	—	—	—	—	—	—	+ 1 500	- 1 500	+ 1 500	- 1 500	800	1 000
—	—	—	—	—	—	—	—	—	—	+ 1 500	- 1 500	1 000	1 250
—	—	—	—	—	—	—	—	—	—	+ 1 500	- 1 500	1 250	1 600
—	—	—	—	—	—	—	—	—	—	—	—	1 600	2 000

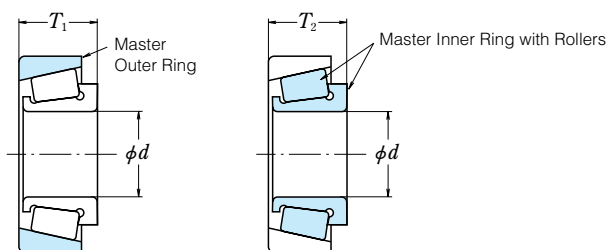

Table 2. 4 Tolerances for Inch Design Tapered Roller Bearings

Table 2. 4. 1 Tolerances for Inner Ring Bore Diameter

Units:μm

Nominal Bore Diameter <i>d</i>				Δd_s			
over		incl		CLASS 4, 2		CLASS 3, 0	
(mm)	(inch)	(mm)	(inch)	high	low	high	low
76.200	3.0000	266.700	10.5000	+ 25	0	+ 13	0
266.700	10.5000	304.800	12.0000	+ 25	0	+ 13	0
304.800	12.0000	609.600	24.0000	+ 51	0	+ 25	0
609.600	24.0000	914.400	36.0000	+ 76	0	+ 38	0
914.400	36.0000	1 219.200	48.0000	+ 102	0	+ 51	0
1 219.200	48.0000	—	—	+ 127	0	+ 76	0

Remarks Some of these tolerances conform to the NSK Standard.

Table 2. 4. 2 Tolerances for Outer Ring Outside Diameter

Nominal Outside Diameter <i>D</i>				ΔD_s			
over		incl		CLASS 4, 2		CLASS 3, 0	
(mm)	(inch)	(mm)	(inch)	high	low	high	low
—	—	266.700	10.5000	+ 25	0	+ 13	0
266.700	10.5000	304.800	12.0000	+ 25	0	+ 13	0
304.800	12.0000	609.600	24.0000	+ 51	0	+ 25	0
609.600	24.0000	914.400	36.0000	+ 76	0	+ 38	0
914.400	36.0000	1 219.200	48.0000	+ 102	0	+ 51	0
1 219.200	48.0000	—	—	+ 127	0	+ 76	0

Remarks Some of these tolerances conform to the NSK Standard.

Table 2. 4. 3 Tolerances for

Nominal Bore Diameter <i>d</i>				Nominal Outside Diameter ⁽¹⁾ <i>D</i>				ΔT_s					
over		incl		over		incl		Single Row					
(mm)	(inch)	(mm)	(inch)	(mm)	(inch)	(mm)	(inch)	CLASS 4		CLASS 3 ⁽¹⁾		CLASS 0	
								high	low	high	low	high	low
—	—	101.600	4.0000	—	—	—	—	+ 203	0	+ 203	- 203	+ 203	- 203
101.600	4.0000	127.000	5.0000	—	—	—	—	+ 356	- 254	+ 203	- 203	+ 203	- 203
127.000	5.0000	304.800	12.0000	—	—	—	—	+ 356	- 254	+ 203	- 203	+ 203	- 203
304.800	12.0000	609.600	24.0000	—	—	508.000	20.0000	+ 381	- 381	+ 203	- 203	—	—
304.800	12.0000	609.600	24.0000	—	—	—	—	—	—	+ 381	- 381	—	—
609.600	24.0000	—	—	—	—	—	—	+ 381	- 381	+ 381	- 381	—	—

Notes ⁽¹⁾ The division of the nominal outside diameter *D* is applied for Class 3 of single and double row bearings (except KF type).

Remarks Some of these tolerances conform to the NSK Standard.

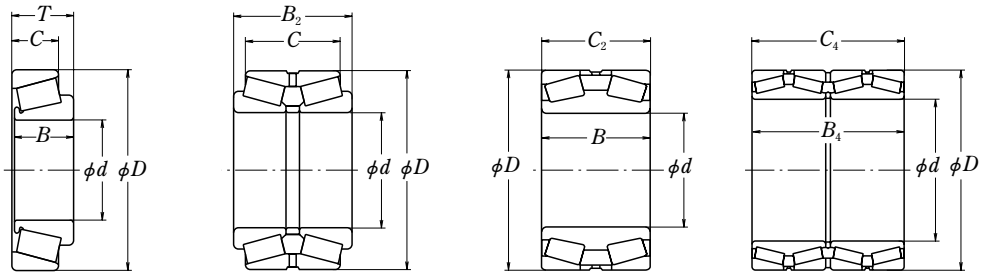

and Radial Runout of Inner and Outer Rings

Units: μm

K_{ia}, K_{ea}			
CLASS 4	CLASS 2	CLASS 3	CLASS 0
max.	max.	max.	max.
51	38	8	4
51	38	8	4
51	38	18	—
76	51	51	—
76	—	76	—
76	—	76	—

Overall Width and Combined Width

Units: μm

$\Delta_{B2S}, \Delta_{C2S}$								$\Delta_{B4S}, \Delta_{C4S}$	
Double-Row KBE, KDE, KH, KDH								Four-Row KV	
CLASS 4		CLASS 3 (!)		CLASS 0		CLASS 4, 3		CLASS 4, 3	
high	low	high	low	high	low	high	low	high	low
+ 406	0	+ 406	- 406	+ 406	- 406	+ 254	0	+ 1 524	- 1 524
+ 711	- 508	+ 406	- 406	+ 406	- 406	+ 254	0	+ 1 524	- 1 524
+ 711	- 508	+ 406	- 406	+ 406	- 406	+ 762	0	+ 1 524	- 1 524
+ 762	- 762	+ 406	- 406	—	—	+ 762	0	+ 1 524	- 1 524
—	—	+ 762	- 762	—	—	—	—	—	—
+ 762	- 762	+ 762	- 762	—	—	+ 762	0	+ 1 524	- 1 524

Table 2. 5 Tolerances for Thrust Ball Bearings

Table 2. 5. 1 Tolerances for Shaft Washer Bore Diameter and Running Accuracy

Units:µm

Nominal Bore Diameter <i>d</i> (mm)		Δd_{mp}				V_{dp}		S_i or S_e			
		Normal CLASS 6 CLASS 5		CLASS 4		Normal CLASS 6 CLASS 5	CLASS 4	Normal	CLASS 6	CLASS 5	CLASS 4
over	incl	high	low	high	low	max.	max.	max.	max.	max.	max.
80	120	0	-20	0	-15	15	11	15	8	4	3
120	180	0	-25	0	-18	19	14	15	9	5	4
180	250	0	-30	0	-22	23	17	20	10	5	4
250	315	0	-35	0	-25	26	19	25	13	7	5
315	400	0	-40	0	-30	30	23	30	15	7	5
400	500	0	-45	0	-35	34	26	30	18	9	6
500	630	0	-50	0	-40	38	30	35	21	11	7
630	800	0	-75	0	-50	—	—	40	25	13	8
800	1 000	0	-100	—	—	—	—	45	30	15	—
1 000	1 250	0	-125	—	—	—	—	50	35	18	—

Table 2. 5. 2 Tolerances for Outside Diameter of Housing Washers

Units:µm

Nominal Outside Diameter <i>D</i> (mm)		ΔD_{mp}				V_{Dp}			
		Flat Seat Type						Normal CLASS 6 CLASS 5	CLASS 4
		Normal CLASS 6 CLASS 5		CLASS 4		max.	max.		
over	incl	high	low	high	low	max.	max.		
80	120	0	-22	0	-13	17	10		
120	180	0	-25	0	-15	19	11		
180	250	0	-30	0	-20	23	15		
250	315	0	-35	0	-25	26	19		
315	400	0	-40	0	-28	30	21		
400	500	0	-45	0	-33	34	25		
500	630	0	-50	0	-38	38	29		
630	800	0	-75	0	-45	55	34		
800	1 000	0	-100	—	—	75	—		
1 000	1 250	0	-125	—	—	—	—		
1 250	1 600	0	-160	—	—	—	—		

Table 2. 5. 3 Tolerances for Thrust Ball Bearing Height

Units: μm

Nominal Bore Diameter d (mm)		ΔT_s	
		Normal, CLASS 6 CLASS 5, CLASS 4	
over	incl	high	low
80	120	0	- 150
120	180	0	- 175
180	250	0	- 200
250	315	0	- 225
315	400	0	- 300
400	500	0	- 350
500	630	0	- 450
630	800	0	- 550
800	1 000	0	- 700
1 000	1 250	0	- 900

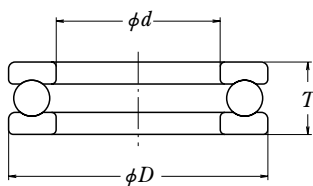

Table 2. 6 Tolerances for Tapered Roller Thrust Bearings

Table 2. 6. 1 Tolerances for Bore Diameters of Shaft Washers and Height (Metric, Class Normal)

Units: μm

Nominal Bore Diameter d (mm)		Δd_{mp}		ΔT_s	
over	incl	high	low	high	low
80	120	0	-20	0	-150
120	180	0	-25	0	-175
180	250	0	-30	0	-200
250	315	0	-35	0	-225
315	400	0	-40	0	-300
400	500	0	-45	0	-350
500	630	0	-50	0	-450
630	800	0	-75	0	-550
800	1 000	0	-100	0	-700
1 000	1 250	0	-125	0	-900
1 250	1 600	0	-160	0	-1 200

Table 2. 6. 2 Tolerances for Housing washer Outside Diameters (Metric, Class Normal)

Units: μm

Nominal Outside Diameter D (mm)		ΔD_{mp}	
over	incl	high	low
180	250	0	-30
250	315	0	-35
315	400	0	-40
400	500	0	-45
500	630	0	-50
630	800	0	-75
800	1 000	0	-100
1 000	1 250	0	-125
1 250	1 600	0	-160
1 600	2 000	0	-200

Table 2. 6. 3 Tolerances for Bore Diameters of Shaft Washers and Height (Inch)

Units: μm

Nominal Bore Diameter d				Δd_{mp}		ΔT_s	
over		incl		high	low	high	low
(mm)	(inch)	(mm)	(inch)				
—	—	304.800	12.0000	+ 25	0	+ 381	- 381
304.800	12.0000	609.600	24.0000	+ 51	0	+ 381	- 381
609.600	24.0000	914.400	36.0000	+ 76	0	+ 381	- 381
914.400	36.0000	1 219.200	48.0000	+ 102	0	+ 381	- 381

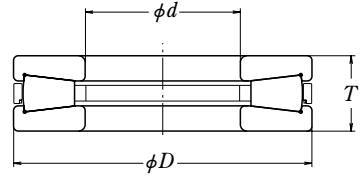

Table 2. 6. 4 Tolerances for Housing Washer Outside Diameters (Inch)

Units: μm

Nominal Outside Diameter D				ΔD_{mp}	
over		incl		high	low
(mm)	(inch)	(mm)	(inch)		
—	—	304.800	12.0000	+ 25	0
304.800	12.0000	609.600	24.0000	+ 51	0
609.600	24.0000	914.400	36.0000	+ 76	0
914.400	36.0000	1 219.200	48.0000	+ 102	0
1 219.200	48.0000	—	—	+ 127	0

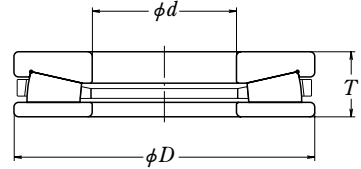

Table 2. 7 Tolerances for Spherical Thrust Roller Bearings

Table 2. 7. 1 Tolerances for Bore Diameters of Shaft Washer and Height (Class Normal)

Units: μm

Nominal Bore Diameter d (mm)		Δd_{mp}		V_{d_p}	Reference		
					S_d	ΔT_s	
over	incl	high	low	max.	max.	high	low
80	120	0	-20	15	25	+200	-200
120	180	0	-25	19	30	+250	-250
180	250	0	-30	23	30	+300	-300
250	315	0	-35	26	35	+350	-350
315	400	0	-40	30	40	+400	-400
400	500	0	-45	34	45	+450	-450

- Remarks**
1. The bore diameter “no-go side” tolerances (high) specified in this table do not necessarily apply within a distance of 1.2 times the chamfer dimension r (max.) from the washer face.
 2. Some of these tolerances conform to the NSK Standard.
 3. Please consult with NSK for tolerances of bore diameter over 500mm.

Table 2. 7. 2 Tolerances for Housing Washer Outside Diameter (Class Normal)

Units: μm

Nominal Outside Diameter D (mm)		ΔD_{mp}	
over	incl	high	low
120	180	0	-25
180	250	0	-30
250	315	0	-35
315	400	0	-40
400	500	0	-45
500	630	0	-50
630	800	0	-75
800	1 000	0	-100

- Remarks**
1. The outside diameter “no-go side” tolerances (low) specified in this table do not necessarily apply within a distance of 1.2 times the chamfer dimension r (max.) from the washer face.
 2. Some of these tolerances conform to the NSK Standard.
 3. Please consult with NSK for tolerances of outside diameter over 1000mm.

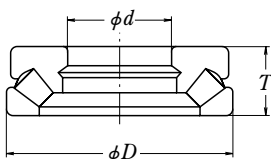
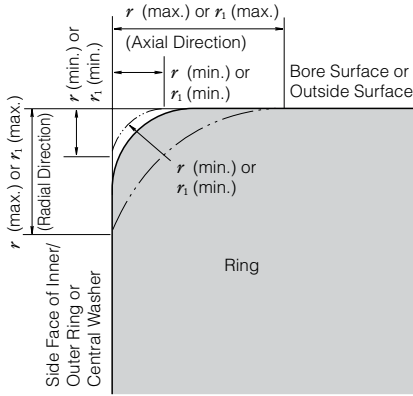

Table 2. 8 Chamfer Dimension Limits (for Metric Design Bearings)

Table 2. 8. 1 Chamfer Dimension Limits for Radial Bearings (Excluding Tapered Roller Bearings)

Units : mm



r : Chamfer Dimension of Inner/Outer Ring
 r_1 : Chamfer Dimension of Inner/Outer Ring (Front Side) or of Central Washer of Thrust Ball Bearings

Remarks The precise shape of chamfer surfaces has not been specified but its profile in the axial plane shall not intersect an arc of radius r (min.) or r_1 (min.) touching the side face of an inner ring or central washer and bore surface, on the side face of an outer ring and outside surface.

Permissible Chamfer Dimension for Inner/Outer Rings r (min.) or r_1 (min.)	Nominal Bore Diameter d		Permissible Chamfer Dimension for Inner/Outer Rings r (max.) or r_1 (max.)		Reference Corner Radius of Shaft or Housing r_a max.
			Radial Direction	Axial Direction	
	over	incl			
0.6	—	40	1	2	0.6
	40	—	1.3	2	
1	—	50	1.5	3	1
	50	—	1.9	3	
1.1	—	120	2	3.5	1
	120	—	2.5	4	
1.5	—	120	2.3	4	1.5
	120	—	3	5	
2	—	80	3	4.5	2
	80	220	3.5	5	
	220	—	3.8	6	
2.1	—	280	4	6.5	2
	280	—	4.5	7	
2.5	—	100	3.8	6	2
	100	280	4.5	6	
	280	—	5	7	
3	—	280	5	8	2.5
	280	—	5.5	8	
4	—	—	6.5	9	3
	—	—	8	10	
6	—	—	10	13	5
	—	—	12.5	17	
	—	—	15	19	
12	—	—	18	24	10
	—	—	21	30	
15	—	—	25	38	12
19	—	—			15

Table 2. 8. 2 Chamfer Dimension Limits for Tapered Roller Bearings

Units : mm

Permissible Chamfer Dimension for Inner/Outer Rings	Nominal Bore or Nominal Outside Diameter ⁽¹⁾ <i>d</i> or <i>D</i>		Permissible Chamfer Dimension for Inner /Outer Rings <i>r</i> (max.)		Reference
					Camer Radius of Shaft or Housing <i>r_a</i>
<i>r</i> (min.)	over	incl	Radial Direction	Axial Direction	
0.6	—	40	1.1	1.7	0.6
	40	—	1.3	2	
1	—	50	1.6	2.5	1
	50	—	1.9	3	
1.5	—	120	2.3	3	1.5
	120	250	2.8	3.5	
	250	—	3.5	4	
2	—	120	2.8	4	2
	120	250	3.5	4.5	
	250	—	4	5	
2.5	—	120	3.5	5	2
	120	250	4	5.5	
	250	—	4.5	6	
3	—	120	4	5.5	2.5
	120	250	4.5	6.5	
	250	400	5	7	
	400	—	5.5	7.5	
4	—	120	5	7	3
	120	250	5.5	7.5	
	250	400	6	8	
	400	—	6.5	8.5	
5	—	180	6.5	8	4
	180	—	7.5	9	
6	—	180	7.5	10	5
	180	—	9	11	

Notes ⁽¹⁾ Inner rings are classified by *d* and outer rings by *D*.

Table 2. 8. 3 Chamfer Dimension Limits for Thrust Bearings

Units : mm

Permissible Chamfer Dimension for Shaft (or Central)/Housing Washers <i>r</i> (min.) or <i>r₁</i> (min.)	Permissible Chamfer Dimension for Shaft (or Central)/Housing Washers <i>r</i> (max.) or <i>r₁</i> (max.)	Reference
		Camer Radius of Shaft or Housing <i>r_a</i>
	Radial or Axial Direction	
0.6	1.5	0.6
	2.2	1
1.1	2.7	1
	3.5	1.5
2	4	2
	4.5	2
3	5.5	2.5
	6.5	3
5	8	4
	10	5
6	10	5
	12.5	6
9.5	15	8
	18	10
12	18	10
	21	12
15	21	12
	25	15
19	25	15

3. FITS AND INTERNAL CLEARANCES

3.1 Fits

3.1.1 Importance of Proper Fits

In the case of a rolling bearing with the inner ring fitted to the shaft with only slight interference, a harmful circumferential slipping may occur between the inner ring and shaft. This slipping of the inner ring, which is called "creep", results in a circumferential displacement of the ring relative to the shaft if the interference fit is not sufficiently tight.

When creep occurs, the fitted surfaces become adraded, causing wear and considerable damage to the shaft. Abnormal heating and vibration may also occur due to abrasive metallic particles entering the interior of the bearing.

It is important to prevent creep by having sufficient interference to firmly secure that ring which rotates to either the shaft or housing. Creep cannot always be eliminated using only axial tightening through the bearing ring faces. Generally, it is not necessary, however, to provide interference for rings subjected only to stationary loads. Fits are sometimes made without any interference for either the inner or outer ring, to accommodate certain operating conditions, or to facilitate mounting and dismounting. In this case, to prevent damage to the fitting surfaces due to creep, lubrication or other applicable methods should be considered.

3.1.2 Selection of Fit

(1) Load Conditions and Fit

The proper fit may be selected from Table 3.1 based on the load and operating conditions.

(2) Magnitude of Load and Interference

The interference of the inner ring is slightly reduced by the bearing load; therefore, the loss of interference should be estimated using the following equations:

$$\Delta d_{F1} = 0.08 \sqrt{\frac{d}{B}} F_r \times 10^{-3} \dots\dots (N) \quad \dots\dots (3.1)$$

$$\Delta d_{F2} = 0.25 \sqrt{\frac{d}{B}} F_r \times 10^{-3} \dots\dots \{kgf\}$$

- where Δd_F : Interference decrease of inner ring (mm)
- d : Bearing bore diameter (mm)
- B : Nominal inner ring width (mm)
- F_r : Radial load applied on bearing (N), {kgf}

Table 3.1 Loading Conditions and Fits

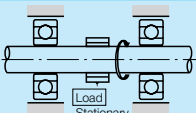
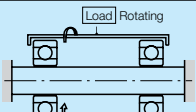
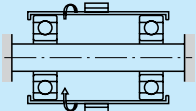
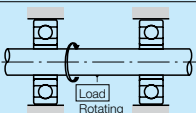
Load Application	Bearing Operation		Load Conditions	Fitting	
	Inner Ring	Outer Ring		Inner Ring	Outer Ring
	Rotating	Stationary	Rotating Inner Ring Load	Tight Fit	Loose Fit
	Stationary	Rotating	Stationary Outer Ring Load		
	Stationary	Rotating	Rotating Outer Ring Load	Loose Fit	Tight Fit
	Rotating	Stationary	Stationary Inner Ring Load		
Direction of load indeterminate due to variation of direction or unbalanced load	Rotating or Stationary	Rotating or Stationary	Direction of Load Indeterminate	Tight Fit	Tight Fit

Under operating conditions with light or normal loads, the interference decrease should be obtained using Equation (3.1).

However, in the case of heavy loads where the radial load exceeds 20% of the basic static load rating C_{or} , the loss of interference should be calculated using Equation (3.2):

$$\Delta d_F \geq 0.02 \frac{F_r}{B} \times 10^{-3} \dots\dots\dots(N) \dots\dots\dots(3.2)$$

$$\Delta d_F \geq 0.2 \frac{F_r}{B} \times 10^{-3} \dots\dots\dots\{kgf\}$$

where Δd_F : Effective interference (mm)
 F_r : Radial load applied on bearing (N), {kgf}
 B : Nominal inner ring width (mm)

(3) Interference Variation Caused by Temperature Difference between Bearing and Shaft of Housing

The effective interference decreases due to the increasing bearing temperature during operation. If the temperature difference between the bearing and housing is ΔT (°C), then the temperature difference between the fitted surfaces of the shaft and inner ring is estimated to be about (0.1 to 0.15) ΔT . The decrease in the interference of the inner ring due to this temperature difference Δd_T may be calculated using Equation (3.3):

$$\Delta d_T = (0.10 \text{ to } 0.15) \Delta T \cdot \alpha \cdot d$$

$$\doteq 0.0015 \Delta T \cdot d \times 10^{-3} \dots\dots\dots(3.3)$$

where Δd_T : Decrease in interference of inner ring due to temperature difference (mm)
 ΔT : Temperature difference between bearing interior and surrounding parts (°C)
 α : Coefficient of linear expansion of bearing steel = 12.5×10^{-6} (1/°C)
 d : Bearing nominal bore diameter (mm)

In addition, depending on the temperature difference between the outer ring and housing, or difference in their coefficients of linear expansion, the interference may increase.

(4) Effective Interference and Finish of Shaft and Housing

Since the roughness of fitted surfaces is reduced during fitting, the effective interference becomes less than the apparent interference. The amount of this interference decrease varies depending on the roughness of the surfaces

and may be estimated using the following equations:

For ground shafts $\Delta d = \frac{d}{d+2} \Delta d_a \dots\dots\dots(3.4)$

For machined shafts $\Delta d = \frac{d}{d+3} \Delta d_a \dots\dots\dots(3.5)$

where Δd : Effective interference (mm)
 Δd_a : Apparent interference (mm)
 d : Bearing nominal bore diameter (mm)

According to Equations (3.4) and (3.5), the effective interference of bearings with a bore diameter of less than 150mm is about 95% of the apparent interference.

(5) Fitting Stress and Ring Expansion and Contraction

When bearings are mounted with interference on a shaft or in a housing, the rings either expand or contract and stress is produced. Excessive interference may damage the bearings; therefore, as a general guide, the maximum interference should be kept under approximately 7/10 000 of the shaft diameter.

3.1.3 Recommended Fits

As described previously, many factors, such as the characteristics and magnitude of bearing load, temperature differences, means of bearing mounting and dismounting, must be considered when selecting the proper fit.

If the housing is thin or the bearing is mounted on a hollow shaft, a tighter than usual fit is necessary. A split housing often deforms the bearing into an oval shape; therefore, a split housing should be avoided when a tight fit with the outer ring is required.

The fits of both the inner and outer rings should be tight in application where the shaft is subjected to considerable vibration.

The recommended fits for some common applications are shown in Tables 3.2 to 3.7. In the case of unusual operating conditions, it is advisable to consult NSK.

Table 3. 2 Fits of Radial Bearings with Shafts

Load Conditions	Examples	Shaft Diameter (mm)			Tolerance of Shaft	Remarks	
		Ball Brgs	Cylindrical Roller Brgs, Tapered Roller Brgs	Spherical Roller Brgs			
Radial Bearings with Cylindrical Bores							
Rotating Outer Ring Load	Easy axial displacement of inner ring on shaft desirable.	Wheels on Stationary Axles	All Shaft Diameters			g6	Use g5 and h5 where accuracy is required. In case of large bearings, f6 can be used to allow easy axial movement.
	Easy axial displacement of inner ring on shaft unnecessary	Tension Pulley Rope Sheaves				h6	
Rotating Inner Ring Load of Direction of Load Indeterminate	Light Load (<0.06C _r ⁽¹⁾) or variable Load	Pumps, Blowers, Transport Vehicles, Precision Machinery, Machine Tools	80 to 100	—	—	js6 (j6)	Use fitting tolerance grade 5 where high accuracy is required and high precision brgs. are used.
			100 to 200	40 to 140	—	k6	
	—	140 to 200	—	m6			
	Normal Loads (0.06 to 0.13 C _r ⁽¹⁾)	General Bearing Applications, Medium and Large Motors, Turbines, Pumps, Engine Main Bearings, Gears, Woodworking Machines	80 to 100	—	—	k5 to 6	k6 and m6 can be used for single-row tapered roller bearings and single-row angular contact ball bearings instead of k5 and m5.
			100 to 140	80 to 100	—	m5 to 6	
			140 to 200	100 to 140	80 to 100	m6	
			200 to 280	140 to 200	100 to 140	n6	
			—	200 to 400	140 to 280	p6	
	—	—	280 to 500	r6			
	Heavy Loads (>0.13C _r ⁽¹⁾) or Shock Loads	Industrial Vehicles, Traction Motors, Construction Equipment, Crushers	—	80 to 140	50 to 100	n6	More than normal bearing internal clearance is necessary.
—			140 to 200	100 to 140	p6		
—			over 200	140 to 200	r6		
—	—	200 to 500	r7				
Axial Loads Only		All Shaft Diameters			js6 (j6)	—	
Radial Bearings with Tapered Bores and Sleeves							
All Types of Loading	General bearing Applications	All Shaft Diameters			h9/IT5	IT5 and IT7 mean that the deviation of the shaft from its true geometric form, e. g. roundness and taper should be within the tolerances of IT5 and IT7 respectively.	
	Transmission Shafts, Woodworking Spindles				h10/IT7		

Notes ⁽¹⁾ C_r represents the basic radial load rating of the bearing.

Remarks This table is applicable only to solid steel shafts.

Table 3. 3 Fits of Thrust Bearings with Shafts

Load Conditions	Examples	Shaft Diameter (mm)	Tolerance of Shaft	Remarks
Central Axial Load Only	Main Shafts of Lathes	All Shaft Diameters	h6 or js6 (j6)	—
Combined Radial and Axial Loads (Spherical Thrust Roller Bearings)	Stationary Inner Ring Load	Cone Crushers	All Shaft Diameters	
	Rotating Inner Ring Load of Direction of Load Indeterminate	Paper Pulp Refiners, Plastic Extruders	< 200	k6
			200 to 400	m6
		over 400	n6	

Table 3. 4 Fits of Radial Bearings with Housings

Load Conditions			Examples	Tolerances for Housing Bores	Axial Displacement of Outer Ring	Remarks
Solid Housings	Rotating Outer Ring Loads	Heavy Loads on Bearing in Thin-Walled Housing Heavy Shock Loads	Crane Travelling Wheels	P7	Impossible	—
		Normal or Heavy Loads	Vibrating Screens	N7		
		Light or Variable Loads	Conveyor Rollers Rope Sheaves Tension Pulleys	M7		
	Direction of Load Indeterminate	Heavy Shock Loads	Traction Motors	K7	Generally Impossible	If axial displacement of the outer ring is not required.
Normal or Heavy Loads		Pumps Crankshaft Main Bearings Medium and Large Motors				
Solid of Split Housings	Rotating Inner Ring Loads	Normal or Light Loads	General Bearing Applications, Railway Axleboxes Plummer Blocks Paper Dryers	JS7 (J7)	Possible	Axial displacement of outer ring is necessary.
		Loads of All kinds		H7	Easy Displacement	—
		Normal or Light Loads		H8		
Solid Housings	Direction of Load Indeterminate	High Temperature Rise of Inner Ring Through Shaft	High Speed Centrifugal Compressor Free Bearings	G7	Possible	—
		Accurate Running Desirable under Normal and Light Loads		High Speed Centrifugal Compressor Fixed Bearings		
	Rotating Inner Ring Loads	Accurate Running and High Rigidity Desirable under Variable Loads	Cylindrical Roller Bearings for Machine Tool Main Spindle		M6 or N6	Impossible

Remarks This table is applicable to cast iron and steel housings. For housings made of light alloy, the interference should be tighter than those in this table.

Table 3. 5 Fits of Thrust Bearings with Housings

Load Conditions		Bearing Types	Tolerances for Housing Bores	Remarks	
Axial Loads Only		Thrust Ball Bearings	Clearance over 0.25mm	For General Applications	
		Cylindrical Roller Thrust Bearings			H8
		Spherical Thrust Roller Bearings Steep Angle Tapered Roller Bearings	Outer ring has radial clearance.	When radial loads are sustained by other bearings.	
Combined Radial and Axial Loads	Stationary Outer Ring Loads	Spherical Thrust Roller Bearings	H7 or JS7 (J7)	—	
	Rotating Outer Ring Loads of Direction of Load Indeterminate		K7		Normal Loads
			M7		Relatively Heavy Radial Loads

Table 3. 6 Fits of Inch Design Tapered Roller Bearings with Shafts

(1) Bearings of Precision Classes 4 and 2

Units:μm

Operating Conditions		Nominal Bore Diameters d				Bore Diameter Tolerances Δd_s		Shaft Diameter Tolerances		Remarks
		over		incl		high	low	high	low	
		(mm)	(inch)	(mm)	(inch)					
Rotating Inner Ring Loads	Normal Loads	76.200	3.0000	304.800	12.0000	+ 25	0	+ 64	+ 38	For bearings with $d \leq 152.4\text{mm}$, those having a bigger than normal clearance are usually used.
		304.800	12.0000	609.600	24.0000	+ 51	0	+ 127	+ 76	
		609.600	24.0000	914.400	36.0000	+ 76	0	+ 190	+ 114	
Rotating Inner Ring Loads	Heavy Loads Shock Loads High Speeds	76.200	3.0000	304.800	12.0000	+ 25	0	※		In general, bearings having a bigger than normal clearance are used. ※ means that the average clearance is about 0.0005 d .
		304.800	12.0000	609.600	24.0000	+ 51	0	※		
		609.600	24.0000	914.400	36.0000	+ 76	0	+ 381	+ 305	
Rotating Outer Ring Loads	Normal Loads without Shocks	76.200	3.0000	304.800	12.0000	+ 25	0	+ 25	0	When heavy or shock loads exist, the figures in the above (Rotating inner ring loads, heavy or shock loads) apply.
		304.800	12.0000	609.600	24.0000	+ 51	0	+ 51	0	
		609.600	24.0000	914.400	36.0000	+ 76	0	+ 76	0	
Rotating Outer Ring Loads	Normal Loads without Shocks	76.200	3.0000	304.800	12.0000	+ 25	0	0	- 25	The inner ring can be displaced axially.
		304.800	12.0000	609.600	24.0000	+ 51	0	0	- 51	
		609.600	24.0000	914.400	36.0000	+ 76	0	0	- 76	

Remarks If four-row tapered roller bearings are mounted on roll necks with a clearance, refer to Table 4 on page B 339.

(2) Bearings of Precision Classes 3 and 0 ⁽¹⁾

Units:μm

Operating Conditions		Nominal Bore Diameters d				Bore Diameter Tolerances Δd_s		Shaft Diameter Tolerances		Remarks
		over		incl		high	low	high	low	
		(mm)	(inch)	(mm)	(inch)					
Rotating Inner Ring Loads	Precision Machine-Tool Main Spindles	76.200	3.0000	304.800	12.0000	+ 13	0	+ 30	+ 18	—
		304.800	12.0000	609.600	24.0000	+ 25	0	+ 64	+ 38	
		609.600	24.0000	914.400	36.0000	+ 38	0	+ 102	+ 64	
Rotating Inner Ring Loads	Heavy Loads Shock Loads High Speeds	76.200	3.0000	304.800	12.0000	+ 13	0	—	—	A minimum clearance of about 0.00025 d is used.
		304.800	12.0000	609.600	24.0000	+ 25	0	—	—	
		609.600	24.0000	914.400	36.0000	+ 38	0	—	—	
Rotating Outer Ring Loads	Precision Machine-Tool Main Spindles	76.200	3.0000	304.800	12.0000	+ 13	0	+ 30	+ 18	—
		304.800	12.0000	609.600	24.0000	+ 25	0	+ 64	+ 38	
		609.600	24.0000	914.400	36.0000	+ 38	0	+ 102	+ 64	

Notes ⁽¹⁾ For bearings with d greater than 304.8mm, Class 0 does not exist.

Table 3. 7 Fits of Inch Design Tapered Roller Bearings with Housings

(1) Bearings of Precision Classes 4 and 2

Units:µm

Operating Conditions		Nominal Outside Diameters <i>D</i>				Outside Diameter Tolerances ΔD_s		Housing Bore Diameter Tolerances		Remarks
		over		incl		high	low	high	low	
		(mm)	(inch)	(mm)	(inch)					
Rotating Outer Ring Loads	Used either on free-end or fixed-end	76.200	3.0000	127.000	5.0000	+ 25	0	+ 76	+ 51	The outer ring can be easily displaced axially.
		127.000	5.0000	304.800	12.0000	+ 25	0	+ 76	+ 51	
		304.800	12.0000	609.600	24.0000	+ 51	0	+ 152	+ 102	
		609.600	24.0000	914.400	36.0000	+ 76	0	+ 229	+ 152	
Rotating Inner Ring Loads	The outer ring position can be adjusted axially.	76.200	3.0000	127.000	5.0000	+ 25	0	+ 25	0	The outer ring can be displaced axially.
		127.000	5.0000	304.800	12.0000	+ 25	0	+ 51	0	
		304.800	12.0000	609.600	24.0000	+ 51	0	+ 76	+ 25	
		609.600	24.0000	914.400	36.0000	+ 76	0	+ 127	+ 51	
Rotating Outer Ring Loads	The outer ring position cannot be adjusted axially.	76.200	3.0000	127.000	5.0000	+ 25	0	- 25	- 51	Generally, the outer ring is fixed axially.
		127.000	5.0000	304.800	12.0000	+ 25	0	- 25	- 51	
		304.800	12.0000	609.600	24.0000	+ 51	0	- 25	- 76	
		609.600	24.0000	914.400	36.0000	+ 76	0	- 25	- 102	
Rotating Outer Ring Loads	Normal Loads The outer ring position cannot be adjusted axially.	76.200	3.0000	127.000	5.0000	+ 25	0	- 25	- 51	The outer ring is fixed axially.
		127.000	5.0000	304.800	12.0000	+ 25	0	- 25	- 51	
		304.800	12.0000	609.600	24.0000	+ 51	0	- 25	- 76	
		609.600	24.0000	914.400	36.0000	+ 76	0	- 25	- 102	

Remarks If four-row tapered roller bearings are mounted on roll necks with a clearance, refer to Table 5 on page B 339.

(2) Bearings of Precision Classes 3 and 0 (1)

Units:µm

Operating Conditions		Nominal Outside Diameters <i>D</i>				Outside Diameter Tolerances ΔD_s		Housing Bore Diameter Tolerances		Remarks
		over		incl		high	low	high	low	
		(mm)	(inch)	(mm)	(inch)					
Rotating Inner Ring Loads	Used on free-end	—	6.0000	152.400	6.0000	+ 13	0	+ 38	+ 25	The outer ring can be easily displaced axially.
		152.400	6.0000	304.800	12.0000	+ 13	0	+ 38	+ 25	
		304.800	12.0000	609.600	24.0000	+ 25	0	+ 64	+ 38	
		609.600	24.0000	914.400	36.0000	+ 38	0	+ 89	+ 51	
Rotating Inner Ring Loads	Used on fixed-end	—	6.0000	152.400	6.0000	+ 13	0	+ 25	+ 13	The outer ring can be displaced axially.
		152.400	6.0000	304.800	12.0000	+ 13	0	+ 25	+ 13	
		304.800	12.0000	609.600	24.0000	+ 25	0	+ 51	+ 25	
		609.600	24.0000	914.400	36.0000	+ 38	0	+ 76	+ 38	
Rotating Inner Ring Loads	The outer ring position can be adjusted axially.	—	6.0000	152.400	6.0000	+ 13	0	+ 13	0	Generally, the outer ring is fixed axially.
		152.400	6.0000	304.800	12.0000	+ 13	0	+ 25	0	
		304.800	12.0000	609.600	24.0000	+ 25	0	+ 25	0	
		609.600	24.0000	914.400	36.0000	+ 38	0	+ 38	0	
Rotating Inner Ring Loads	The outer ring position cannot be adjusted axially.	—	6.0000	152.400	6.0000	+ 13	0	0	- 13	The outer ring is fixed axially.
		152.400	6.0000	304.800	12.0000	+ 13	0	0	- 25	
		304.800	12.0000	609.600	24.0000	+ 25	0	0	- 25	
		609.600	24.0000	914.400	36.0000	+ 38	0	0	- 38	
Rotating Outer Ring Loads	Normal Loads The outer ring position cannot be adjusted axially.	76.200	3.0000	152.400	6.0000	+ 13	0	- 13	- 25	The outer ring is fixed axially.
		152.400	6.0000	304.800	12.0000	+ 13	0	- 13	- 38	
		304.800	12.0000	609.600	24.0000	+ 25	0	- 13	- 38	
		609.600	24.0000	914.400	36.0000	+ 38	0	- 13	- 51	

Notes (1) For bearing with *D* greater than 304.8 mm, Class 0 does not exist.

3.2 Bearing Internal Clearances

3.2.1 Internal Clearances and Their Standards

The internal clearance in rolling bearings in operation greatly influences bearing performance including fatigue life, vibration, noise, heat-generation, etc.

Consequently, the selection of the proper internal clearance is one of the most important tasks when choosing a bearing after the type and size have been determined.

This bearing internal clearance is the combined clearances between the inner/outer rings and rolling elements. The radial and axial clearances are defined as the total amount that one ring can be displaced relative to the other in the radial and axial directions respectively (Fig. 3.1).

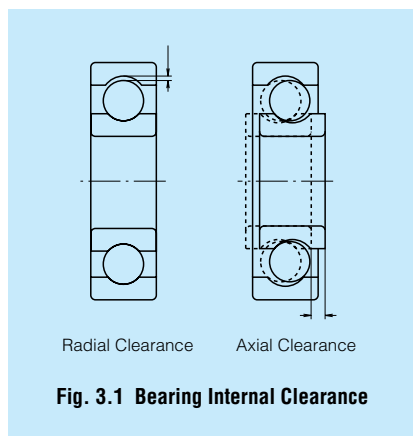

To obtain accurate measurements, the clearance is generally measured by applying a specified measuring load on the bearing; therefore, the measured clearance (sometimes called “measured clearance” to make a distinction) is always slightly larger than the theoretical internal clearance (called “geometrical clearance” for radial bearings) by the amount of elastic deformation caused by the measuring load.

Therefore, the theoretical internal clearance may be obtained by correcting the measured clearance by the amount of elastic deformation. However, in the case of roller bearings this elastic deformation is negligibly small.

Usually the clearance before mounting is the one specified as the theoretical internal clearance.

In Table 3.8, reference table and page numbers are listed by bearing types.

Table 3.8 Index for Radial Internal Clearances by Bearing Types

Bearing Types		Table Number	Page Number
Deep Groove Ball Bearings		3.9	A40
Deep Groove Ball Bearings	For Motors	3.10.1	A40
Cylindrical Roller Bearings		3.10.2	A40
Cylindrical Roller Bearings	With Cylindrical Bores (Interchangeable)	3.11	A41
	With Cylindrical Bores (Matched)		
	With Tapered Bores (Matched)		
Spherical Roller Bearings	With Cylindrical Bores	3.12	A42
	With Tapered Bores		
Double-Row and Combined Tapered Roller Bearings		3.13	A43
Combined Angular Contact Ball Bearings (1)		3.14	A44

Notes (1) Values given are axial clearances.

Table 3. 9 Radial Internal Clearances in Deep Groove Ball Bearings

Units:µm

Nominal Bore Diameter <i>d</i> (mm)		Clearances									
		C2		CN		C3		C4		C5	
over	incl	min.	max.	min.	max.	min.	max.	min.	max.	min.	max.
80	100	1	18	12	36	30	58	53	84	75	120
100	120	2	20	15	41	36	66	61	97	90	140
120	140	2	23	18	48	41	81	71	114	105	160
140	160	2	23	18	53	46	91	81	130	120	180
160	180	2	25	20	61	53	102	91	147	135	200
180	200	2	30	25	71	63	117	107	163	150	230
200	225	2	35	25	85	75	140	125	195	175	265
225	250	2	40	30	95	85	160	145	225	205	300
250	280	2	45	35	105	90	170	155	245	225	340
280	315	2	55	40	115	100	190	175	270	245	370
315	355	3	60	45	125	110	210	195	300	275	410
355	400	3	70	55	145	130	240	225	340	315	460
400	450	3	80	60	170	150	270	250	380	350	510
450	500	3	90	70	190	170	300	280	420	390	570
500	560	10	100	80	210	190	330	310	470	440	630
560	630	10	110	90	230	210	360	340	520	490	690
630	710	20	130	110	260	240	400	380	570	540	760
710	800	20	140	120	290	270	450	430	630	600	840
800	900	20	160	140	320	300	500	480	700	670	940
900	1 000	20	170	150	350	330	550	530	770	740	1 040
1 000	1 120	20	180	160	380	360	600	580	850	820	1 150
1 120	1 250	20	190	170	410	390	650	630	920	890	1 260

Table 3. 10 Radial Internal Clearances in Bearings for Electric Motors

Table 3. 10. 1 Deep Groove Ball Bearings for Electric Motors

Nominal Bore Dia. <i>d</i> (mm)		Clearance		Remarks	
		CM		Recommended Fit	
over	incl	min.	max.	Shaft	Housing Bore
80	100	18	30	k5	H6 to 7 or JS6 to 7 (J6 to 7)
100	120	18	30		
120	160	24	38	m5	

Table 3. 10. 2 Cylindrical Roller Bearing for Electric Motors

Nominal Bore Dia. <i>d</i> (mm)		Clearance				Remarks	
		interchangeable CT		Matched CM		Recommended Fit	
over	incl	min.	max.	min.	max.	Shaft	Housing Bore
80	100	35	60	35	55	m5	JS6 to 7 (J6 to 7) or K6 to 7
100	120	35	65	35	60		
120	140	40	70	40	65		
140	160	50	85	50	80	n6	
160	180	60	95	60	90		
180	200	65	105	65	100		

Table 3. 11 Radial Internal Clearances in Cylindrical Roller Bearings

Units:μm

Nominal Bore Dia. <i>d</i> (mm)		Interchangeable Clearances in Bearings with Cylindrical Bores									Matched Clearances in Bearings with Cylindrical Bores												
		C2		CN		C3		C4		C5		CC1		CC2		CC (1)		CC3		CC4		CC5	
over	incl	min.	max.	min.	max.	min.	max.	min.	max.	min.	max.	min.	max.	min.	max.	min.	max.	min.	max.	min.	max.	min.	max.
80	100	15	50	50	85	75	110	105	140	155	190	10	30	25	45	45	70	80	105	105	125	155	180
100	120	15	55	50	90	85	125	125	165	180	220	10	30	25	50	50	80	95	120	120	145	180	205
120	140	15	60	60	105	100	145	145	190	200	245	10	35	30	60	60	90	105	135	135	160	200	230
140	160	20	70	70	120	115	165	165	215	225	275	10	35	35	65	65	100	115	150	150	180	225	260
160	180	25	75	75	125	120	170	170	220	250	300	10	40	35	75	75	110	125	165	165	200	250	285
180	200	35	90	90	145	140	195	195	250	275	330	15	45	40	80	80	120	140	180	180	220	275	315
200	225	45	105	105	165	160	220	220	280	305	365	15	50	45	90	90	135	155	200	200	240	305	350
225	250	45	110	110	175	170	235	235	300	330	395	15	50	50	100	100	150	170	215	215	265	330	380
250	280	55	125	125	195	190	260	260	330	370	440	20	55	55	110	110	165	185	240	240	295	370	420
280	315	55	130	130	205	200	275	275	350	410	485	20	60	60	120	120	180	205	265	265	325	410	470
315	355	65	145	145	225	225	305	305	385	455	535	20	65	65	135	135	200	225	295	295	360	455	520
355	400	100	190	190	280	280	370	370	460	510	600	25	75	75	150	150	225	255	330	330	405	510	585
400	450	110	210	210	310	310	410	410	510	565	665	25	85	85	170	170	255	285	370	370	455	565	650
450	500	110	220	220	330	330	440	440	550	625	735	25	95	95	190	190	285	315	410	410	505	625	720
500	560	—	—	—	—	—	—	—	—	—	—	30	105	105	210	210	315	350	455	455	560	695	800
560	630	—	—	—	—	—	—	—	—	—	—	30	115	115	230	230	345	390	505	505	620	780	895
630	710	—	—	—	—	—	—	—	—	—	—	30	130	130	260	260	390	435	565	565	695	870	1 000
710	800	—	—	—	—	—	—	—	—	—	—	35	145	145	290	290	435	485	630	630	775	980	1 125
800	900	—	—	—	—	—	—	—	—	—	—	35	160	160	320	320	480	540	700	700	860	1 100	1 260
900	1 000	—	—	—	—	—	—	—	—	—	—	35	180	180	360	360	540	600	780	780	960	1 200	1 380

Notes (1) CC is the symbol for matched normal clearance for cylindrical roller bearings.

Units:μm

Nominal Bore Dia. <i>d</i> (mm)		Matched Clearances in Bearings with Tapered Bores																			
		CC9 (1)		CC1		CC2		CC (2)		CC3		CC4		CC5							
over	incl	min.	max.	min.	max.	min.	max.	min.	max.	min.	max.	min.	max.	min.	max.	min.	max.	min.	max.	min.	max.
80	100	10	25	25	45	45	70	80	105	105	125	125	150	180	205						
100	120	10	25	25	50	50	80	95	120	120	145	145	170	205	230						
120	140	15	30	30	60	60	90	105	135	135	160	160	190	230	260						
140	160	15	35	35	65	65	100	115	150	150	180	180	215	260	295						
160	180	15	35	35	75	75	110	125	165	165	200	200	240	285	320						
180	200	20	40	40	80	80	120	140	180	180	220	220	260	315	355						
200	225	20	45	45	90	90	135	155	200	200	240	240	285	350	395						
225	250	25	50	50	100	100	150	170	215	215	265	265	315	380	430						
250	280	25	55	55	110	110	165	185	240	240	295	295	350	420	475						
280	315	30	60	60	120	120	180	205	265	265	325	325	385	470	530						
315	355	30	65	65	135	135	200	225	295	295	360	360	430	520	585						
355	400	35	75	75	150	150	225	255	330	330	405	405	480	585	660						
400	450	40	85	85	170	170	255	285	370	370	455	455	540	650	735						
450	500	45	95	95	190	190	285	315	410	410	505	505	600	720	815						
500	560	—	—	105	210	210	315	350	455	455	560	560	665	800	905						
560	630	—	—	115	230	230	345	390	505	505	620	620	735	895	1 010						
630	710	—	—	130	260	260	390	435	565	565	695	695	825	1 000	1 130						
710	800	—	—	145	290	290	435	485	630	630	775	775	920	1 125	1 270						
800	900	—	—	160	320	320	480	540	700	700	860	860	1 020	1 260	1 420						
900	1 000	—	—	180	360	360	540	600	780	780	960	960	1 120	1 380	1 540						

Notes (1) Clearance CC9 is applicable to cylindrical roller bearings with tapered bores in ISO Tolerance Classes 5 and 4.
 (2) CC is the symbol for matched normal clearance for cylindrical roller bearings.

Table 3. 12 Radial Internal Clearances in Spherical Roller Bearings

Units:μm

Nominal Bore Dia. <i>d</i> (mm)		Clearances in Bearings with Cylindrical Bores										Clearances in Bearings with Tapered Bores									
		C2		CN		C3		C4		C5		C2		CN		C3		C4		C5	
over	incl	min.	max.	min.	max.	min.	max.	min.	max.	min.	max.	min.	max.	min.	max.	min.	max.	min.	max.	min.	max.
80	100	35	60	60	100	100	135	135	180	180	225	55	80	80	110	110	140	140	180	180	230
100	120	40	75	75	120	120	160	160	210	210	260	65	100	100	135	135	170	170	220	220	280
120	140	50	95	95	145	145	190	190	240	240	300	80	120	120	160	160	200	200	260	260	330
140	160	60	110	110	170	170	220	220	280	280	350	90	130	130	180	180	230	230	300	300	380
160	180	65	120	120	180	180	240	240	310	310	390	100	140	140	200	200	260	260	340	340	430
180	200	70	130	130	200	200	260	260	340	340	430	110	160	160	220	220	290	290	370	370	470
200	225	80	140	140	220	220	290	290	380	380	470	120	180	180	250	250	320	320	410	410	520
225	250	90	150	150	240	240	320	320	420	420	520	140	200	200	270	270	350	350	450	450	570
250	280	100	170	170	260	260	350	350	460	460	570	150	220	220	300	300	390	390	490	490	620
280	315	110	190	190	280	280	370	370	500	500	630	170	240	240	330	330	430	430	540	540	680
315	355	120	200	200	310	310	410	410	550	550	690	190	270	270	360	360	470	470	590	590	740
355	400	130	220	220	340	340	450	450	600	600	750	210	300	300	400	400	520	520	650	650	820
400	450	140	240	240	370	370	500	500	660	660	820	230	330	330	440	440	570	570	720	720	910
450	500	140	260	260	410	410	550	550	720	720	900	260	370	370	490	490	630	630	790	790	1 000
500	560	150	280	280	440	440	600	600	780	780	1 000	290	410	410	540	540	680	680	870	870	1 100
560	630	170	310	310	480	480	650	650	850	850	1 100	320	460	460	600	600	760	760	980	980	1 230
630	710	190	350	350	530	530	700	700	920	920	1 190	350	510	510	670	670	850	850	1 090	1 090	1 360
710	800	210	390	390	580	580	770	770	1 010	1 010	1 300	390	570	570	750	750	960	960	1 220	1 220	1 500
800	900	230	430	430	650	650	860	860	1 120	1 120	1 440	440	640	640	840	840	1 070	1 070	1 370	1 370	1 690
900	1 000	260	480	480	710	710	930	930	1 220	1 220	1 570	490	710	710	930	930	1 190	1 190	1 520	1 520	1 860
1 000	1 120	290	530	530	780	780	1 020	1 020	1 330	—	—	530	770	770	1 030	1 030	1 300	1 300	1 670	—	—
1 120	1 250	320	580	580	860	860	1 120	1 120	1 460	—	—	570	830	830	1 120	1 120	1 420	1 420	1 830	—	—
1 250	1 400	350	640	640	950	950	1 240	1 240	1 620	—	—	620	910	910	1 230	1 230	1 560	1 560	2 000	—	—

Table 3. 13 Radial Internal Clearances in Double-Row and Combined Tapered Roller Bearings

Units: μm

Cylindrical Bore Tapered Bore Nominal Bore Dia. <i>d</i> (mm)		Clearances											
		C1		C2		CN		C3		C4		C5	
		—		C1		C2		CN		C3		C4	
over	incl	min.	max.	min.	max.	min.	max.	min.	max.	min.	max.	min.	max.
80	100	0	25	25	50	50	75	80	105	105	130	155	180
100	120	5	30	30	55	55	80	90	115	120	145	180	210
120	140	5	35	35	65	65	95	100	130	135	165	200	230
140	160	10	40	40	70	70	100	110	140	150	180	220	260
160	180	10	45	45	80	80	115	125	160	165	200	250	290
180	200	10	50	50	90	90	130	140	180	180	220	280	320
200	225	20	60	60	100	100	140	150	190	200	240	300	340
225	250	20	65	65	110	110	155	165	210	220	270	330	380
250	280	20	70	70	120	120	170	180	230	240	290	370	420
280	315	30	80	80	130	130	180	190	240	260	310	410	460
315	355	30	80	80	130	140	190	210	260	290	350	450	510
355	400	40	90	90	140	150	200	220	280	330	390	510	570
400	450	45	95	95	145	170	220	250	310	370	430	560	620
450	500	50	100	100	150	190	240	280	340	410	470	620	680
500	560	60	110	110	160	210	260	310	380	450	520	700	770
560	630	70	120	120	170	230	290	350	420	500	570	780	850
630	710	80	130	130	180	260	310	390	470	560	640	870	950
710	800	90	140	150	200	290	340	430	510	630	710	980	1 060
800	900	100	150	160	210	320	370	480	570	700	790	1 100	1 200
900	1 000	120	170	180	230	360	410	540	630	780	870	1 200	1 300
1 000	1 120	130	190	200	260	400	460	600	700	—	—	—	—
1 120	1 250	150	210	220	280	450	510	670	770	—	—	—	—
1 250	1 400	170	240	250	320	500	570	750	870	—	—	—	—

Remarks Axial internal clearance $\Delta_i = \Delta_r \cot \alpha \approx \frac{1.5}{e} \Delta_r$
 where Δ_r : Radial internal clearance
 α : Contact angle
 e : Constant (Listed in bearing tables)

Table 3. 14 Axial Internal Clearances in Combined Angular Contact Ball Bearings (Measured Clearance)

Units: μm

Nominal Bore Diameter d (mm)		Axial Internal Clearances											
		Contact Angle 30°						Contact Angle 40°					
		CN		C3		C4		CN		C3		C4	
over	incl	min.	max.	min.	max.	min.	max.	min.	max.	min.	max.	min.	max.
80	100	49	74	74	99	99	125	35	60	60	85	85	110
100	120	72	97	97	120	120	145	52	77	77	100	100	125
120	140	85	115	115	145	145	175	63	93	93	125	125	155
140	160	90	120	120	150	150	180	66	96	96	125	125	155
160	180	95	125	125	155	155	185	68	98	98	130	130	160
180	200	110	140	140	170	170	200	80	110	110	140	140	170

Remarks This table is applicable to bearings in Tolerance Classes N and 6. For internal axial clearances in bearings in tolerance classes better than 5 and contact angles of 15° and 25°, it is advisable to consult NSK.

3.2.2 Selection of Bearing Internal Clearances

Among the bearing internal clearances listed in the tables, the CN Clearance is adequate for standard operating conditions. The clearance becomes progressively smaller from C2 to C1 and larger from C3 to C5 in that order.

Standard operating conditions are defined as those where the inner ring speed is less than normal the load is less than normal ($P \leq 0.1C_r$), and the bearing is tight-fitted on the shaft.

Since the internal clearance varies with the fit and temperature differences in operation, the change in radial clearance in a roller bearing is shown in Fig. 3.2 as an example.

(1) Decrease in Radial Clearance Caused by Fitting and Residual Clearance

When the inner ring or the outer ring is tight-fitted on a shaft or in a housing, a decrease in the radial internal clearance is caused by the expansion or contraction of the bearing rings. The decrease varies according to the bearing type and size and design of the shaft and housing. The amount of this decrease is approximately 70 to 90% of the interference. The internal clearance after subtracting this decrease from the theoretical internal clearance Δ_0 is called the residual clearance, Δ_f .

(2) Decrease in Radial Internal Clearance Caused by Temperature Difference between Inner and Outer Rings and Effective Clearance

The frictional heat generated during operation is conducted away through the shaft and housing. Since housings generally conduct heat better than shafts, the temperature of the inner ring and the rolling elements is usually higher than that of the outer ring by 5 to 10°C. If the shaft is heated or the housing is cooled, the difference in temperature between the inner and outer rings is greater. The radial clearance decreases due to the thermal expansion caused by the temperature difference between the inner and outer rings. The amount of this decrease can be calculated using the following equations:

$$\delta_t \doteq \alpha \Delta_t D_e \dots \dots \dots (3.6)$$

where δ_t : Decrease in radial clearance due to temperature difference between inner and outer rings (mm)

α : Coefficient of linear expansion of bearing steel $\doteq 12.5 \times 10^{-6}$ (1/°C)

Δ_t : Temperature difference between inner and outer rings (°C)

D_e : Outer ring raceway diameter (mm)

For ball bearings

$$D_e \doteq \frac{1}{5} (4D+d) \dots \dots \dots (3.7)$$

For roller bearings

$$D_e \doteq \frac{1}{4} (3D+d) \dots \dots \dots (3.8)$$

The clearance after subtracting this δ_t from the residual clearance, Δ_f is called the effective clearance, Δ . Theoretically, the longest life of a bearing can be expected when the effective clearance is slightly negative. However, it is difficult to achieve such an ideal condition, and an excessive negative clearance will greatly shorten the bearing life.

Therefore, a clearance of zero or a slightly positive amount, instead of a negative one, should be selected.

When single-row angular contact ball bearings or tapered roller bearings are used facing each other, there should be a small effective clearance, unless a preload is required.

When two cylindrical roller bearings with a rib on one side are used facing each other, it is necessary to provide adequate axial clearance to allow for shaft elongation during operation.

The radial clearances used in some specific applications are given in Table 3.15.

Under special operating conditions, it is advisable to consult NSK.

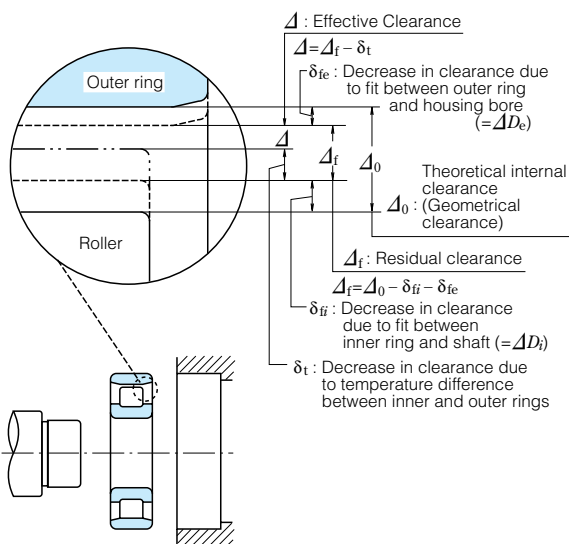

Fig. 3.2 Change in Radial Internal Clearance of Bearings

Table 3. 15 Examples of Clearances for Specific Applications

Operating Conditions	Examples	Internal Clearance
When steam passes through hollow shafts or roller shafts are heated.	Dryers in paper making machines	C3, C4
	Table rollers for rolling mills	C3
When impact loads and vibration are severe or when both the inner and outer rings are tight-fitted.	Traction motors for railways	C4
	Vibrating screens	C3, C4
	Fluid couplings	C4
	Final reduction gears for tractors	C4
When clearance is adjusted after mounting to prevent shaft deflection, etc.	Main shafts of lathes	CC9, CC1

4. LUBRICATION

4.1 Purposes of Lubrication

The main purposes of lubrication are to reduce friction and wear inside the bearings that may cause premature failure. The effects of lubrication may be briefly explained as follows:

(1) Reduction of Friction and Wear

Direct metallic contact between the bearing rings, rolling elements and cage, which are the basic components of a bearing, is prevented by an oil film which reduces the friction and wear in the contact areas.

(2) Extension of Fatigue Life

The rolling fatigue life of bearings depends greatly upon the viscosity and film thickness between the rolling contact surfaces. A heavy film thickness prolongs the fatigue life, but it is shortened if the viscosity of the oil is too low so the film thickness is insufficient.

(3) Dissipation of Frictional Heat and Cooling

Circulation lubrication may be used to carry away frictional heat or heat transferred from the outside to prevent the bearing from overheating and the oil from deteriorating.

(4) Others

Adequate lubrication also helps to prevent foreign material from entering the bearings and guards against corrosion or rusting.

4.2 Lubricating Methods

The various lubricating methods are first divided into either grease or oil lubrication. Satisfactory bearing performance can be achieved by adopting the lubricating method which is most suitable for the particular application and operating condition.

In general, oil offers superior lubrication; however grease lubrication allows a simpler structure around the bearings. A comparison of grease and oil lubrication is given in Table 4.1.

Table 4.1 Comparison of Grease and Oil Lubrication

Item	Grease Lubrication	Oil Lubrication
Housing Structure and Sealing Method	Simple	May be complex. Careful maintenance required.
Speed	Limiting speed is 65% to 80% of that with oil lubrication.	High limiting speed.
Cooling Effect	Poor	Heat transfer is possible using forced oil circulation.
Fluidity	Poor	Good
Full Lubricant Replacement	Sometimes difficult	Easy
Removal of Foreign Matter	Removal of particles from grease is impossible.	Easy
External Contamination due to Leakage	Surroundings seldom contaminated by leakage.	Often leaks without proper countermeasures. Not suitable if external contamination must be avoided.

4.2.1 Grease Lubrication

(1) Grease Quantity

The quantity of grease to be packed in a housing depends on the housing design and free space, grease characteristics, and ambient temperature.

Sufficient grease must be packed inside the bearing including the cage guide face. The available space inside the housing to be packed with grease depends on the speed as follows:

Table 4.2 Packed Grease Amount

Speed	$\frac{\text{Grease volume}}{\text{Internal space}}$	Remarks
Low	2/3 to 1	To prevent particles and water from entering
Normal	1/2 to 2/3	
High	1/3 to 1/2	The higher the speed, the less the grease.

(2) Replacement of Grease

Grease, once packed, usually need not be replenished for a long time; however, for severe operating conditions, grease should be frequently replenished or replaced. In such cases, the bearing housing should be designed to facilitate grease replenishment and replacement.

When replenishment intervals are short, provide replenishment and discharge ports at appropriate positions so deteriorated grease is replaced by fresh grease. For example, the housing space on the grease supply side can be divided into several sections with partitions. The grease on the partitioned side gradually passes through the bearings and old grease forced from the bearing is discharged through a grease valve (Fig. 4.1). If a grease valve is not used, the space on the discharge side is made larger than the partitioned side so it can retain the old grease, which is removed periodically by removing the cover.

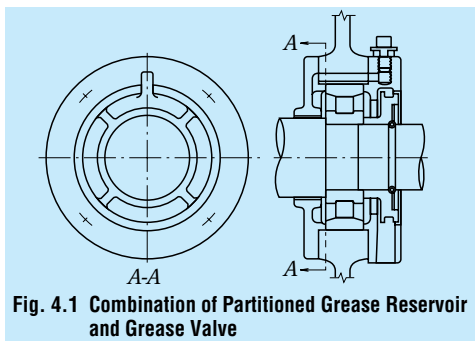

Fig. 4.1 Combination of Partitioned Grease Reservoir and Grease Valve

(3) Replenishing Interval

Even if high-quality grease is used, there is deterioration of its properties with time; therefore, periodic replenishment is required. Figs 4.2 (1) and (2) show the replenishment time intervals for various bearing types running at different speeds. These figures apply only if the temperature of the bearings is less than 70°C; the replenishment time interval must be reduced by half for every 15°C temperature rise of the bearings.

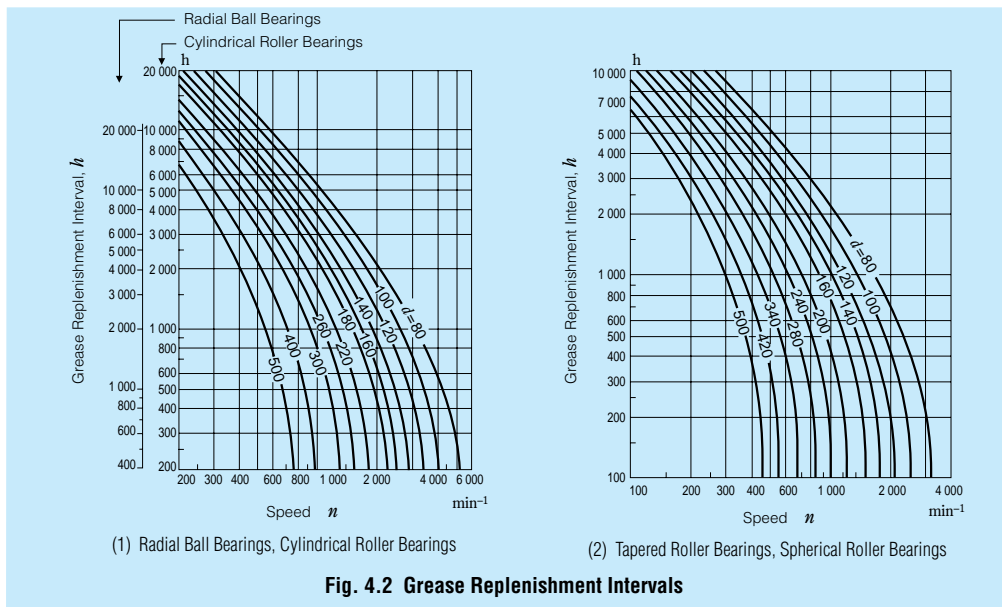

Fig. 4.2 Grease Replenishment Intervals

4.2.2 Oil Lubrication

(1) Oil Bath Lubrication

Oil bath lubrication is a widely used method in the case of low or medium speeds. The oil level should be at the center of the lowest rolling element. It is desirable to provide a sight gauge so the proper oil level may be maintained (Fig. 4.3).

(2) Drip Feed Lubrication

Drip feed lubrication is widely used for small ball bearings operated at relatively high speeds. As shown in Fig. 4.4, oil is stored in a visible oiler. The oil drip rate is controlled with the screw in the top.

(3) Splash Lubrication

With this lubricating method, oil is splashed onto the bearings by gears or a simple rotating disc installed near bearings without submerging the bearings in oil. It is commonly used in various gear boxes. Fig. 4.5 shows this lubricating method used on a reduction gear.

(4) Circulating Lubrication

Circulating lubrication is commonly used for high speed operation requiring bearing cooling and for bearings used at high temperatures. As shown in Fig. 4.6 (a), oil is supplied by the pipe on the right side, it travels through the bearing, and drains out through the pipe on the left. After being cooled in a reservoir, it returns to the bearing through a pump and filter. The oil discharge pipe should be larger than the supply pipe so an excessive amount of oil will not back up in the housing.

(5) Jet Lubrication

Jet lubrication is often used for ultra high speed bearings, such as the bearings in jet engines with a $d_m n$ value (d_m : pitch diameter of rolling element set in mm; n : rotational speed in min^{-1}) exceeding one million. Lubricating oil is sprayed under pressure from one or more nozzles directly into the bearing.

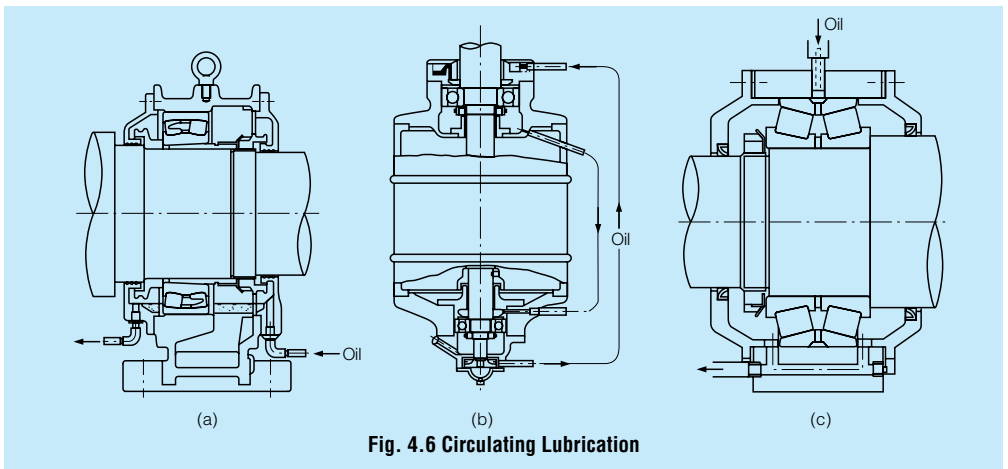
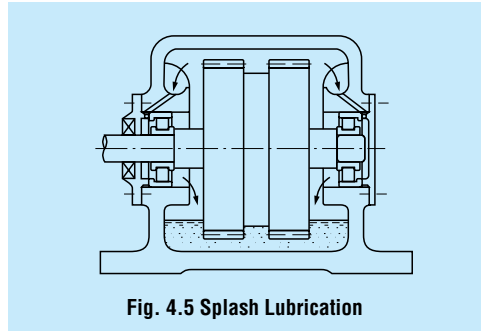
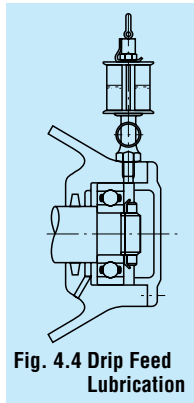
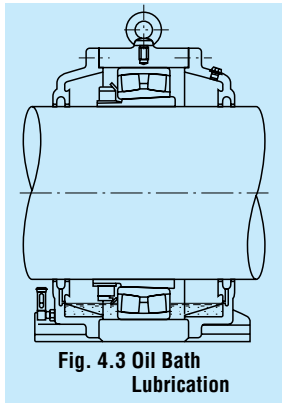

Fig. 4.6 Circulating Lubrication

Fig. 4.7 shows an example of ordinary jet lubrication. In the case of high speed operation, the air surrounding the bearing rotates with it causing the oil jet to be deflected. The jetting speed of the oil from the nozzle should be more than 20% of the circumferential speed of the inner ring outer surface. More uniform cooling and a better temperature distribution is achieved using more nozzles for a given amount of oil. Therefore, it is desirable for the oil to be forcibly discharged so the agitating resistance of the lubricant can be reduced and the oil can effectively carry away the heat.

(6) Oil Mist Lubrication

Oil mist lubrication, also called oil fog lubrication, utilizes an oil mist sprayed into a bearing. This method has the following advantages:

- (a) Because of the small quantity of oil required, the oil agitation resistance is small, and higher speeds are possible.
- (b) Contamination of the vicinity around the bearing is slight because the oil leakage is small.
- (c) It is relatively easy to continuously supply fresh oil; therefore, the bearing life is extended.

This lubricating method is used in bearings for high speed pumps, roll necks of rolling mills, etc (Fig. 4.8).

For oil mist lubrication of large bearings, it is advisable to consult NSK.

(7) Oil-Air Lubricating Method

Using the oil-air lubricating method, a very small amount of oil is discharged intermittently by a constant-quantity piston into a pipe carrying a constant flow of compressed air. The oil flows along the wall of the pipe and approaches a constant flow rate.

The major advantages of oil-air lubrication are:

- (a) Since the minimum necessary amount of oil is supplied, this method is suitable for high speeds because less heat is generated.
- (b) Since the minimum amount of oil is fed continuously, bearing temperature remains stable. Also, because of the small amount of oil, there is almost no atmospheric pollution.
- (c) Since only fresh oil is fed to the bearings, oil deterioration need not be considered.
- (d) Since compressed air is always fed to the bearings, the internal pressure is high, so dust, cutting fluid, etc. cannot enter.

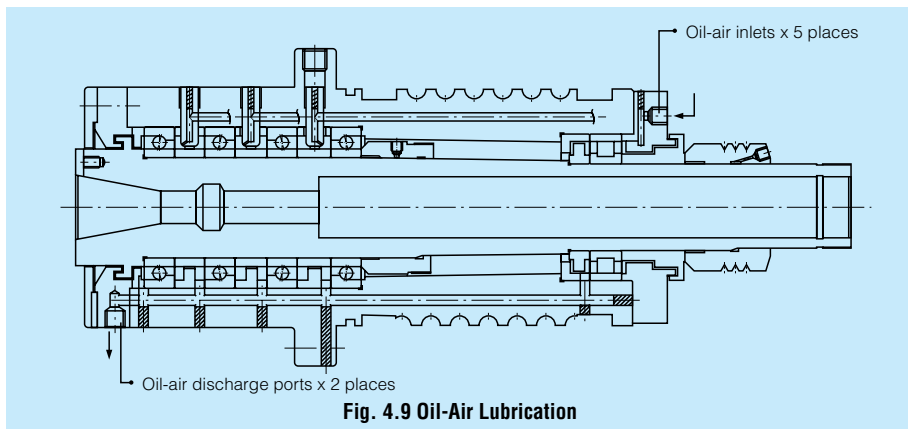
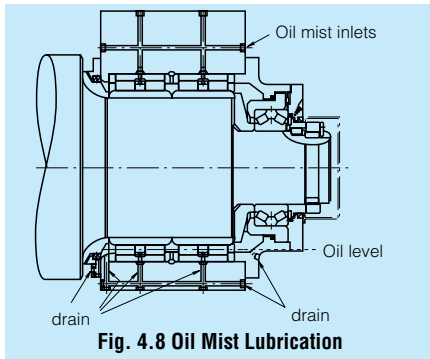
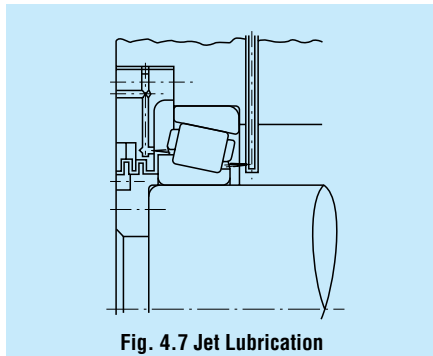

4.3 Lubricants

Table 4.3

4.3.1. Lubricating Grease

Grease is a semi-solid lubricant consisting of a base oil and a thickener. The main types and general properties of grease are shown in Table 4.3. It should be remembered that different brands of same type of grease may have different properties.

(1) Base Oil

Mineral oils or synthetic oils such as silicone or diester oil are mainly used as the base oil for grease. The lubricating properties of grease depend mainly on the characteristics of its base oil. Therefore, the viscosity of the base oil is just as important when selecting grease as when selecting an oil. Usually, grease made with low viscosity base oils are more suitable for high speeds and low temperatures, while greases made with high viscosity base oil are more suited for high temperatures and heavy loads. However, the thickener also influences the lubricating properties of grease; therefore, the selection criteria for grease is not the same as for lubricating oil. Moreover, please be aware that ester-based grease will cause acrylic rubber material to swell, and that silicone-based grease will cause silicone-based material to swell.

(2) Thickener

As thickeners for lubricating grease, there are several types of metallic soaps, inorganic thickeners such as silica gel and bentonite, and heat resisting organic thickeners such as polyurea and fluoric compounds. The type of thickener is closely related to the grease dropping point (1); generally, grease with high dropping point also has a high temperature capability during operation. However, this type of grease does not have a high working temperature unless the base oil is heat resistant. The highest possible working temperature for grease should be determined considering the heat resistance of the base oil, etc. The water resistance of grease depends upon the type of thickener. Sodium soap grease or compound grease containing sodium soap emulsifies when exposed to water or high humidity, and therefore, cannot be used where moisture is prevalent. Moreover, please be aware that urea-based grease will cause fluorine-based material to deteriorate.

(3) Additives

Grease often contains various additives such as antioxidants, corrosion inhibitors, and extreme pressure additives to give it special properties. It is recommended that extreme pressure additives be used in heavy load applications. For long use without replenishment, an antioxidant should be added.

Note (1) The grease dropping point is that temperature at which a grease heated in a specified small container becomes sufficiently fluid to drip.

Name (Popular name)	Lithium Grease		
	Li Soap		
Thickener			
Base Oil			
Properties	Mineral Oil	Diester Oil, Polyatomic Ester Oil	Silicone Oil
Dropping Point, °C	170 to 195	170 to 195	200 to 210
Working Temperatures, °C	-20 to +110	-50 to +130	-50 to +160
Speed capability	Good	Excellent	Good
Mechanical Stability	Good	Good	Good
Pressure Resistance	Fair	Fair	Poor
Water Resistance	Good	Good	Good
Rust Prevention	Good	Good	Poor
Remarks	General purpose grease used for numerous applications	Good low temperature and torque characteristics	Mainly for high temperature applications. Unsuitable for bearings for high speeds or heavy loads or those having numerous sliding-contact areas (roller bearings, etc.)

(4) Consistency

Consistency indicates the “softness” of grease. Table 4.4 shows the relation between consistency and working conditions.

(5) Mixing Different Types of Grease

In general, different brands of grease must not be mixed. Mixing grease with different types of thickeners may destroy its composition and physical properties. Even if the thickeners are of the same type, possible differences in the additive may cause detrimental effects.

Grease Properties

Sodium Grease (Fiber Grease)	Calcium Grease (Cup Grease)	Mixed Base Grease	Complex Base Grease (Complex Grease)	Non-Soap Base Grease (Non-Soap Grease)	
Na Soap	Ca Soap	Na+Ca Soap, Li+Ca Soap, etc.	Ca Complex Soap, Al Complex Soap, Li Complex Soap, etc.	Urea, Bentonite, Carbon Black, Flouric Compounds, Heat Resistant Organic Compound, etc.	
Mineral Oil	Mineral Oil	Mineral Oil	Mineral Oil	Mineral Oil	Synthetic Ester Oil (Diester Oil, Polyatomic Ester Oil, Synthetic Hydrocarbon Oil, Silicone Oil, Fluoric Based Oil)
170 to 210	70 to 90	160 to 190	180 to 300	> 230	> 230
-20 to +130	-20 to +60	-20 to +80	-20 to +130	-10 to +130	< +220
Good	Fair	Good	Good	Good	Fair to Excellent
Good	Poor	Good	Good	Good	Good
Fair	Poor	Fair to Good	Fair to Good	Fair	Fair
Poor	Good	Poor for Na Soap Grease	Good	Good	Good
Poor to Good	Good	Fair to Good	Fair to Good	Fair to Good	Fair to Good
Long and short fiber types are available. Long fiber grease is unsuitable for high speeds. Attention to water and high temperature is required.	Extreme pressure grease containing high viscosity mineral oil and extreme pressure additive (Pb soap, etc.) has high pressure resistance.	Often used for roller bearings and large ball bearings.	Suitable for extreme pressures mechanically stable	Mineral oil base grease is general purpose lubricant. Synthetic oil base grease is recommended for special environments with very high temperatures, acids, alkalis, radioactivity, and exposure to flames.	

Remarks The grease properties shown here can vary between brands.

Table 4. 4 Consistency and Working Conditions

Consistency Number	0	1	2	3	4
Consistency ⁽¹⁾ 1/10 mm	355 to 385	310 to 340	265 to 295	220 to 250	175 to 205
Working Conditions (Application)	<ul style="list-style-type: none"> • For centralized oiling • When fretting is likely to occur 	<ul style="list-style-type: none"> • For centralized oiling • When fretting is likely to occur • For low temperatures 	<ul style="list-style-type: none"> • For general use • For sealed ball bearings 	<ul style="list-style-type: none"> • For general use • For sealed ball bearings • For high temperatures 	<ul style="list-style-type: none"> • For high temperatures • For grease seals

Notes ⁽¹⁾ Consistency: Depth into grease attained by a cone when pressed with a specified weight, indicated in units of 1/10mm. The larger the value, the softer the grease.

4.3.2 Lubricating Oil

The lubricating oils used for rolling bearings are usually highly refined mineral oil or synthetic oil that have a high oil film strength and superior oxidation and corrosion resistance. When selecting a lubricating oil, the viscosity at the operating conditions is important. If the viscosity is too low, a proper oil film is not formed and abnormal wear and seizure may occur. On the other hand, if the viscosity is too high, excessive viscous resistance may cause heating or large power loss. In general, low viscosity oils should be used at high speed; however, the viscosity should increase with increasing bearing load and size. Table 4.5 gives generally recommended viscosities for bearings under normal operating conditions.

For use when selecting the proper lubricating oil, Fig. 4.10 shows the relationship between oil temperature and viscosity, and examples of selection are shown in Table 4.6.

Table 4.5 Bearing Types and Proper Viscosity of Lubricating Oils

Bearing Type	Proper Viscosity at Operating Temperature
Ball Bearings and Cylindrical Roller Bearings	Higher than 13 mm ² /s
Tapered Roller Bearings and Spherical Roller Bearings	Higher than 20 mm ² /s
Spherical Thrust Roller Bearings	Higher than 32 mm ² /s

Remarks 1 mm²/s=1cSt (centistoke)

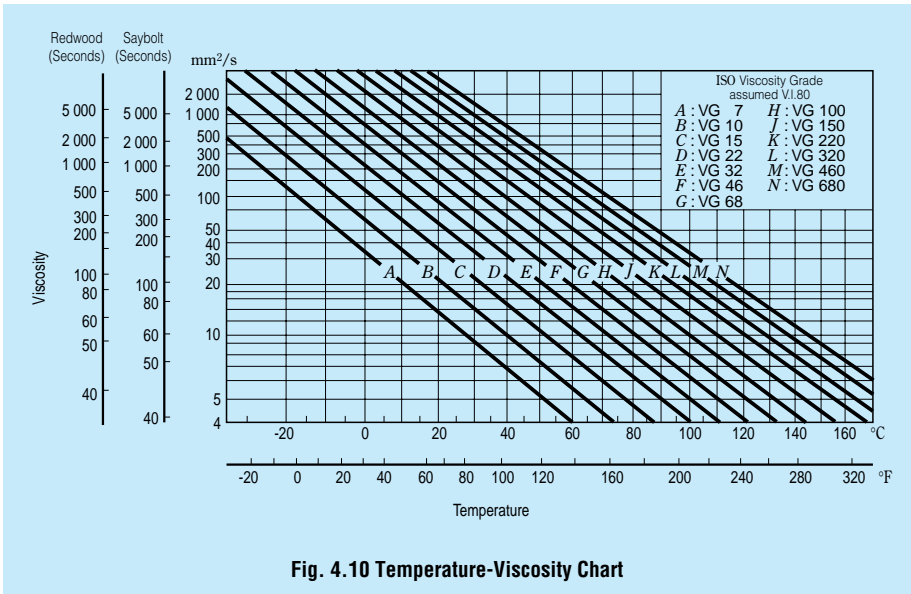

Fig. 4.10 Temperature-Viscosity Chart

Oil Replacement Intervals

Oil replacement intervals depend on the operating conditions and oil quantity.

In those cases where the operating temperature is less than 50°C, and the environmental conditions are good with little dust, the oil should be replaced approximately once a year. However, in cases where the oil temperature is about 100°C, the oil must be changed at least once every three months.

If moisture may enter or if foreign matter may be mixed in the oil, then the oil replacement interval must be shortened. Mixing different brands of oil must be prevented for the same reason given previously for grease.

Table 4. 6 Examples of Selection of Lubricating Oils

Operating Temperature	Speed	Light or Average Load	Heavy or Shock Load
-30 to 0°C	Low, Normal	ISO VG 15, 22, 32 (refrigerating machine oil)	—
0 to 50°C	Low	ISO VG 32, 46, 68 (bearing oil, turbine oil)	ISO VG 46, 68, 100 (bearing oil, turbine oil)
	Normal to High	ISO VG 15, 22, 32 (bearing oil, turbine oil)	ISO VG 22, 32, 46 (bearing oil, turbine oil)
	High	ISO VG 10, 15, 22 (bearing oil)	—
50 to 80°C	Low	ISO VG 100, 150, 220 (bearing oil)	ISO VG 150, 220, 320 (bearing oil)
	Normal to High	ISO VG 46, 68, 100 (bearing oil, turbine oil)	ISO VG 68, 100, 150 (bearing oil, turbine oil)
	High	ISO VG 32, 46, 68 (bearing oil, turbine oil)	—
80 to 110°C	Low	ISO VG 320, 460 (bearing oil)	ISO VG 460, 680 (bearing oil, gear oil)
	Normal to High	ISO VG 150, 220 (bearing oil)	ISO VG 220, 320 (bearing oil)
	High	ISO VG 68, 100 (bearing oil, turbine oil)	—

- Remarks**
1. Refer to Refrigerating Machine Oils (JIS K 2211), Bearing Oils (JIS K 2239), Turbine Oils (JIS K 2213), Gear Oils (JIS K 2219).
 2. If the operating temperature is near the high end of the temperature range listed in the left column, select a high viscosity oil.
 3. If the operating temperature is lower than -30°C or higher than 110°C, it is advisable to consult NSK.

5. BEARING MATERIALS

The bearing rings and rolling elements of rolling bearings are subjected to repetitive high pressure with a small amount of sliding. The cages are subjected to tension and compression and sliding contact with the rolling elements and either or both of the bearing rings.

Therefore, the materials used for the rings, rolling elements, and cages require the following characteristics:

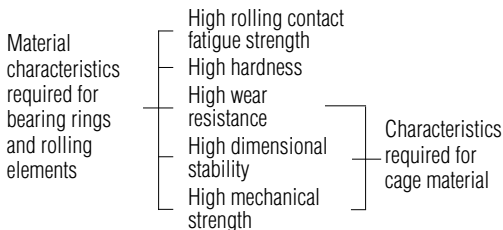

Other necessary characteristics, such as easy production, shock and heat resistance, and corrosion resistance, are required depending on individual applications.

5.1 Materials for Bearing Rings and Rolling Elements

Primarily, high carbon chromium bearing steel (Table 5.1) is used for the bearing rings and rolling elements. Most NSK bearings are made of SUJ2 among the JIS steel types listed in Table 5.1, while the larger bearings generally use SUJ3. The chemical composition of SUJ2 is approximately the same as AISI 52100 specified in the USA, DIN 100 Cr6 in West Germany, and BS 535A99 in England.

For bearings that are subjected to very severe shock loads, carburized low-carbon alloy steels such as chrome steel, chrome molybdenum steel, nickel chrome molybdenum steel, etc. are often used. Such steels, when they are carburized to the proper depth and have sufficient surface hardness, are more shock resistant than normal, through-hardened bearing steels because of the softer energy-absorbing core. The chemical composition of common carburized bearing steels is listed in Table 5.2.

Table 5.1 Chemical Composition of High-Carbon Chromium Bearing Steel (Major Elements)

Standard	Symbols	Chemical Composition (%)						
		C	Si	Mn	P	S	Cr	Mo
JIS G 4805	SUJ 2	0.95 to 1.10	0.15 to 0.35	Less than 0.50	Less than 0.025	Less than 0.025	1.30 to 1.60	—
	SUJ 3	0.95 to 1.10	0.40 to 0.70	0.90 to 1.15	Less than 0.025	Less than 0.025	0.90 to 1.20	—
	SUJ 4	0.95 to 1.10	0.15 to 0.35	Less than 0.50	Less than 0.025	Less than 0.025	1.30 to 1.60	0.10 to 0.25
ASTM A 295	52100	0.93 to 1.05	0.15 to 0.35	0.25 to 0.45	Less than 0.025	Less than 0.015	1.35 to 1.60	Less than 0.10

Table 5.2 Chemical Composition of Carburizing Bearing Steels (Major Elements)

Standard	Symbols	Chemical Composition (%)							
		C	Si	Mn	P	S	Ni	Cr	Mo
JIS G 4052	SCr 420 H	0.17 to 0.23	0.15 to 0.35	0.55 to 0.95	Less than 0.030	Less than 0.030	Less than 0.25	0.85 to 1.25	—
	SCM 420 H	0.17 to 0.23	0.15 to 0.35	0.55 to 0.95	Less than 0.030	Less than 0.030	Less than 0.25	0.85 to 1.25	0.15 to 0.35
	SNCM 220 H	0.17 to 0.23	0.15 to 0.35	0.60 to 0.95	Less than 0.030	Less than 0.030	0.35 to 0.75	0.35 to 0.65	0.15 to 0.30
	SNCM 420 H	0.17 to 0.23	0.15 to 0.35	0.40 to 0.70	Less than 0.030	Less than 0.030	1.55 to 2.00	0.35 to 0.65	0.15 to 0.30
JIS G 4053	SNCM 815	0.12 to 0.18	0.15 to 0.35	0.30 to 0.60	Less than 0.030	Less than 0.030	4.00 to 4.50	0.70 to 1.00	0.15 to 0.30
ASTM A 534	8620 H	0.18 to 0.23	0.15 to 0.35	0.60 to 0.95	Less than 0.025	Less than 0.015	0.35 to 0.75	0.35 to 0.65	0.15 to 0.25
	4320 H	0.17 to 0.23	0.15 to 0.35	0.40 to 0.70	Less than 0.025	Less than 0.015	1.55 to 2.00	0.35 to 0.65	0.20 to 0.30
	9310 H	0.07 to 0.13	0.15 to 0.35	0.40 to 0.70	Less than 0.025	Less than 0.015	2.95 to 3.55	1.00 to 1.40	0.08 to 0.15

Table 5.3 Chemical Composition of High Speed Steel for Bearings Used at High Temperatures

Standard	Symbols	Chemical Composition (%)											
		C	Si	Mn	P	S	Cr	Mo	V	Ni	Cu	Co	W
AISI	M50	0.77 to 0.85	Less than 0.25	Less than 0.35	Less than 0.015	Less than 0.015	3.75 to 4.25	4.00 to 4.50	0.90 to 1.10	Less than 0.10	Less than 0.10	Less than 0.25	Less than 0.25

NSK uses highly pure vacuum-degassed bearing steel containing a minimum of oxygen, nitrogen, and hydrogen compound impurities. The rolling fatigue life of bearings has been remarkably improved using these materials combined with the appropriate heat treatment.

For special purpose bearings, high temperature bearing steel, which has superior heat resistance, and stainless steel having good corrosion resistance may be used. The chemical composition of these special materials are given in Tables 5.3 and 5.4.

5.2 Cage Materials

The low carbon steel shown in Table 5.5 are the main ones for the pressed cages for bearings. Depending on the purpose, brass or stainless steel may be used. For machined cages, high strength brass (Table 5.6) or carbon steel (Table 5.5) is used. Sometimes synthetic resin is also used.

Table 5. 4 Chemical Composition of Stainless Steel for Rolling Bearings (Major Elements)

Standard	Symbols	Chemical Composition (%)						
		C	Si	Mn	P	S	Cr	Mo
JIS G 4303	SUS 440 C	0.95 to 1.20	Less than 1.00	Less than 1.00	Less than 0.040	Less than 0.030	16.00 to 18.00	Less than 0.75
SAE J 405	51440 C	0.95 to 1.20	Less than 1.00	Less than 1.00	Less than 0.040	Less than 0.030	16.00 to 18.00	Less than 0.75

Table 5. 5 Chemical Composition of Steel Sheet and Carbon Steel for Cages (Major Elements)

Classification	Standard	Symbols	Chemical Composition (%)				
			C	Si	Mn	P	S
Steel sheet and strip for pressed cages	JIS G 3141	SPCC	Less than 0.12	—	Less than 0.05	Less than 0.04	Less than 0.045
	BAS 361	SPB 2	0.13 to 0.20	Less than 0.04	0.25 to 0.60	Less than 0.03	Less than 0.030
	JIS G 3311	S 50 CM	0.47 to 0.53	0.15 to 0.35	0.60 to 0.90	Less than 0.03	Less than 0.035
Carbon steel for machined cages	JIS G 4051	S 25 C	0.22 to 0.28	0.15 to 0.35	0.30 to 0.60	Less than 0.03	Less than 0.035

Remarks BAS is Japanese Bearing Association Standard.

Table 5. 6 Chemical Composition of High Strength Brass for Machined Cages

Standard	Symbols	Chemical Composition (%)								
		Cu	Zn	Mn	Fe	Al	Sn	Ni	Impurities	
									Pb	Si
JIS H 5120	CAC301 (HBsC 1)	55.0 to 60.0	33.0 to 42.0	0.1 to 1.5	0.5 to 1.5	0.5 to 1.5	Less than 1.0	Less than 1.0	Less than 0.4	Less than 0.1
JIS H 3250	C 6782	56.0 to 60.5	Residual	0.5 to 2.5	0.1 to 1.0	0.2 to 2.0	—	—	Less than 0.5	—

Remarks Improved HBsC 1 is also used.

BEARING TABLES

BEARING TABLE CONTENTS

	Bore Dia.	Page No.
SINGLE-ROW DEEP GROOVE BALL BEARINGS		B 4
	90 – 1100mm	B 6
ANGULAR CONTACT BALL BEARINGS		B 20
Single/Matched	90 – 775mm	B 24
Double-Row	100 – 280mm	B 42
CYLINDRICAL ROLLER BEARINGS		B 44
Single-Row	100 – 1320mm	B 48
Double-Row	100 – 850mm	B 66
FULL-COMPLEMENT CYLINDRICAL ROLLER BEARINGS		B 78
Single-Row	NCF 100 – 670mm	B 82
Double-Row	NNCF 100 – 500mm	B 86
Double-Row	RS-48, RS-49 100 – 560mm	B 90
Double-Row (Prelubricated)	RS-50 100 – 400mm	B 94
TAPERED ROLLER BEARINGS		B 96
Single-Row (Metric Design)	100 – 1900mm	B102
Single-Row (Inch Design)	100 – 1270mm	B114
Double-Cup, Single Cones	KBE (TDO) 100 – 2000mm	B182
Double-Cup, Single Cones Steep Angle	KDE (TDO) 100 – 1450mm	B246
Double-Cup, Single Cones	KF (TNA) 101.6 – 406.4mm	B252
Double-Cone, Single Cups	KH (TDI) 100 – 1290mm	B262
Double-Cone, Single Cups Steep Angle	KDH (TDI) 100 – 540mm	B282
SPHERICAL ROLLER BEARINGS		B286
	100 – 1590mm	B290
THRUST BEARINGS		B308
Thrust Ball Bearings	90 – 630mm	B312
Cylindrical Roller Thrust Bearings	100 – 360mm	B318
Tapered Roller Thrust Bearings	TT, TTF 101.6 – 600mm	B322
Spherical Thrust Roller Bearings	100 – 900mm	B328

		Bore Dia.	Page No.
ROLLING BEARINGS FOR STEEL MILLS			B 334
ROLL NECK BEARINGS			
Four-Row Tapered Roller Bearings	KV (TQO)	100 – 1500mm	B344
Sealed-Clean Four-Row Tapered Roller Bearings	KVE	100.6 – 825.5mm	B380
Four-Row Cylindrical Roller Bearings	RV	100 – 1120mm	B388
	RVK	110.417 – 633.333mm	B400
Double-Row Tapered Roller Bearings	KDH (TDI)	110 – 1200mm	B402
Double-Direction Tapered Roller Thrust Bearings	TFD	120 – 900mm	B408
Single-Row Deep Groove Ball Bearings		145 – 850mm	B412
Matched Angular Contact Ball Bearings		120 – 580mm	B418
ADJUSTING SCREW BEARINGS			
Tapered Roller Thrust Bearings	TFX	149.225 – 900mm	B424
	TFV	149.225 – 880mm	B428
SENDZIMIR MILL BEARINGS			
Back-Up Roll Bearings		31.75 – 180mm	B434
TRIPLE-RING BEARINGS FOR PAPER MAKING MACHINES		180 – 380mm	B436
CROSSED-ROLLER BEARINGS FOR INDUSTRIAL ROBOTS		100 – 600mm	B440



SINGLE-ROW DEEP GROOVE BALL BEARINGS

Single-Row Deep Groove Ball Bearings

Bore Diameter 90 – 1100mm B6

Design, Types, and Features

Single-row deep groove ball bearings are the most common type of rolling bearings. Their range of application is very wide. The raceway grooves in both the inner and outer rings have circular arcs of slightly larger radius than that of the balls. In addition to radial loads, axial loads can be imposed in either direction. Because of their low torque, they are highly suitable for applications where high speeds and low power loss are required.

For deep groove ball bearings, pressed cages are usually used. For large bearings and high speed applications, machined brass cages are used.

Standard types of deep groove ball bearings are as follows:

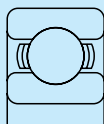

Figure 1
Pressed cage

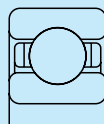

Figure 2
Machined cage

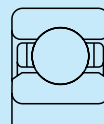

Figure 3
Beveled inner ring

Regarding the deep groove ball bearings used with four-row cylindrical roller bearings for roll necks, refer to Page B412.

Tolerances and

Running Accuracy Table 2.2 (Pages A16 to A19)

Recommended Fits Table 3.2 (Page A35)
Table 3.4 (Page A36)

Internal Clearances Table 3.9 (Page A40)

Permissible Misalignment

The permissible misalignment of single-row deep groove ball bearings varies depending on their size, internal clearance during operation, bearing loads, etc. In general, it is approximately 0.0006 to 0.003 radian ($2'$ to $10'$).

Precautions for Use of Deep Groove Ball Bearings

For deep groove ball bearings, if the bearing load is too small during operation, slippage occurs between the balls and raceways, which may result in smearing. The higher the weight of balls and cage, the higher this tendency becomes, especially for large bearings. If very small bearing loads are expected, please contact **NSK** for selection of an appropriate bearing.

SINGLE-ROW DEEP GROOVE BALL BEARINGS

Bore Diameter 90 – 115 mm

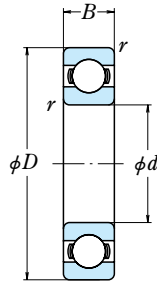

Boundary Dimensions (mm)				Basic Load Ratings (kN)				Factor	Bearing Numbers	Fig- ure ⁽¹⁾
d	D	B	r min.	C_r	C_{0r}	C_r	C_{0r}	f_0		
90	115	13	1	19.0	21.0	1 940	2 140	17.2	6818	1
	125	18	1.1	33.0	31.5	3 350	3 200	16.5	6918	1
	140	16	1	41.5	39.5	4 250	4 000	16.3	16018	1
	140	24	1.5	58.0	50.0	5 950	5 050	15.6	6018	1
	160	30	2	96.0	71.5	9 800	7 300	14.5	6218	1
	190	43	3	143	107	14 500	11 000	13.3	6318	1
95	120	13	1	19.3	22.0	1 970	2 240	17.2	6819	1
	130	18	1.1	33.5	33.5	3 450	3 400	16.6	6919	1
	145	16	1	43.0	42.0	4 350	4 250	16.4	16019	1
	145	24	1.5	60.5	54.0	6 150	5 500	15.8	6019	1
	170	32	2.1	109	82.0	11 100	8 350	14.4	6219	1
	200	45	3	153	119	15 600	12 100	13.3	6319	1
100	125	13	1	19.6	23.0	2 000	2 340	17.3	6820	1
	140	18	1.1	38.5	39.0	3 950	3 950	16.6	B100-3	2
	140	20	1.1	43.0	42.0	4 350	4 250	16.4	6920	1
	150	16	1	42.5	42.0	4 300	4 300	16.5	16020	1
	150	24	1.5	60.0	54.0	6 150	5 550	15.9	6020	1
	180	34	2.1	122	93.0	12 500	9 500	14.4	6220	1
	215	47	3	173	141	17 700	14 400	13.2	6320	1
105	130	13	1	19.8	23.9	2 020	2 440	17.4	6821	1
	145	20	1.1	42.5	42.0	4 300	4 300	16.5	6921	1
	160	18	1	52.0	50.5	5 300	5 150	16.3	16021	1
	160	26	2	72.5	66.0	7 400	6 700	15.8	6021	1
	180	30	2	93.5	78.0	9 550	7 950	15.3	B105-9	2
	190	36	2.1	133	105	13 600	10 700	14.4	6221	1
110	225	49	3	184	154	18 700	15 700	13.2	6321	1
	140	16	1	28.1	32.5	2 860	3 350	17.1	6822	1
	150	20	1.1	43.5	44.5	4 450	4 550	16.6	6922	1
	170	19	1	57.5	56.5	5 850	5 800	16.3	16022	1
	170	28	2	85.0	73.0	8 650	7 450	15.5	6022	1
	200	38	2.1	144	117	14 700	11 900	14.3	6222	1
115	240	50	3	205	179	20 900	18 300	13.2	6322	1
	195	32	2	130	105	13 200	10 700	14.8	B115-1	2

Notes ⁽¹⁾ Refer to page B 5

Dynamic Equivalent Load

$$P = XF_r + YF_a$$

$\frac{f_0 F_r}{C_{0r}}$	e	$\frac{F_a}{F_r} \leq e$		$\frac{F_a}{F_r} > e$	
		X	Y	X	Y
		0.172	0.19	1	0
0.345	0.22	1	0	0.56	1.99
0.689	0.26	1	0	0.56	1.71
1.03	0.28	1	0	0.56	1.55
1.38	0.30	1	0	0.56	1.45
2.07	0.34	1	0	0.56	1.31
3.45	0.38	1	0	0.56	1.15
5.17	0.42	1	0	0.56	1.04
6.89	0.44	1	0	0.56	1.00

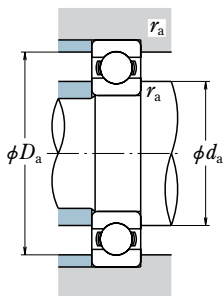

Static Equivalent Load

$$\frac{F_a}{F_r} > 0.8, P_0 = 0.6F_r + 0.5F_a$$

$$\frac{F_a}{F_r} \leq 0.8, P_0 = F_r$$

Abutment and Fillet Dimensions (mm)			Mass (kg)
d_a	D_a	r_a max.	approx.
96	109	1	0.27
101	116	1	0.58
99	132	1	0.87
102	129	1.5	1.19
103	147	2	2.18
108	173	2.5	4.98
101	114	1	0.29
106	121	1	0.60
104	137	1	0.90
108	134	1.5	1.23
111	155	2	2.64
113	183	2.5	5.76
106	119	1	0.31
111	130	1	0.89
111	130	1	0.82
110	142	1	0.94
113	139	1.5	1.29
116	165	2	3.17
118	197	2.5	7.04
111	124	1	0.32
116	135	1	0.85
115	151	1	1.24
119	147	2	1.58
119	167	2	3.32
121	175	2	3.79
123	207	2.5	8.09
117	132	1	0.49
122	140	1	0.89
120	161	1	1.51
124	157	2	1.94
126	185	2	4.45
128	222	2.5	9.51
129	182	2	3.93

SINGLE-ROW DEEP GROOVE BALL BEARINGS

Bore Diameter 120 – 160 mm

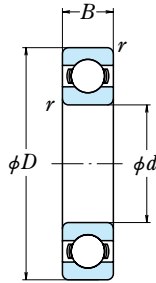

Boundary Dimensions (mm)				Basic Load Ratings (kN) / (kgf)				Factor	Bearing Numbers	Fig- ure ⁽¹⁾	
<i>d</i>	<i>D</i>	<i>B</i>	<i>r</i> min.	<i>C_r</i>	<i>C_{0r}</i>	<i>C_r</i>	<i>C_{0r}</i>	<i>f₀</i>			
120	150	16	1	28.9	35.5	2 950	3 650	17.3	6824	1	
	165	22	1.1	53.0	54.0	5 400	5 500	16.5	6924	1	
	180	19	1	56.5	57.5	5 800	5 850	16.5	16024	1	
	180	28	2	88.0	80.0	9 000	8 150	15.7	6024	1	
	215	40	2.1	155	131	15 800	13 400	14.4	6224	1	
	260	55	3	207	185	21 100	18 800	13.5	6324	1	
125	205	32	2	129	107	13 200	10 900	15.1	B125-2	2	
130	165	18	1.1	37.0	44.0	3 750	4 450	17.1	6826	1	
	180	24	1.5	65.0	67.5	6 650	6 850	16.5	6926	1	
	200	22	1.1	75.5	77.5	7 700	7 900	16.4	16026	1	
140	200	33	2	106	101	10 800	10 300	15.8	6026	1	
	230	40	3	167	146	17 000	14 900	14.5	6226	1	
	280	58	4	229	214	23 400	21 800	13.6	6326	1	
	175	18	1.1	38.5	48.0	3 900	4 850	17.3	6828	1	
140	190	24	1.5	66.5	72.0	6 800	7 300	16.6	6928	1	
	210	22	1.1	77.5	82.5	7 900	8 400	16.5	16028	2	
	210	33	2	110	109	11 200	11 100	16.0	6028	1	
	220	32	3	135	119	13 800	12 100	15.4	B140-2	2	
	250	42	3	166	150	17 000	15 300	14.9	6228	1	
	300	62	4	253	246	25 800	25 100	13.6	6328	1	
	150	190	20	1.1	47.5	58.5	4 850	5 950	17.1	6830	1
		200	24	1.5	73.0	79.5	7 450	8 100	16.6	B150-3	2
		210	28	2	85.0	90.5	8 650	9 200	16.5	6930	1
225		24	1.1	84.0	91.0	8 550	9 250	16.6	16030	2	
225		35	2.1	126	126	12 800	12 800	15.9	6030	1	
270		45	3	176	168	18 000	17 100	15.1	6230	1	
160	320	65	4	274	284	28 000	28 900	13.9	6330	1	
	200	20	1.1	48.5	61.0	4 950	6 250	17.2	6832	1	
	220	28	2	87.0	96.0	8 850	9 800	16.6	6932	1	
	240	25	1.5	99.0	108	10 100	11 000	16.5	16032	2	
	240	38	2.1	137	135	13 900	13 800	15.9	6032	1	
	290	48	3	185	186	18 900	19 000	15.4	6232	1	
	340	68	4	278	287	28 300	29 200	13.9	6332	1	

Notes ⁽¹⁾ Refer to page B 5

Dynamic Equivalent Load

$$P = XF_r + YF_a$$

$\frac{f_0 F_r}{C_{0r}}$	e	$\frac{F_a}{F_r} \leq e$		$\frac{F_a}{F_r} > e$	
		X	Y	X	Y
		0.172	0.19	1	0
0.345	0.22	1	0	0.56	1.99
0.689	0.26	1	0	0.56	1.71
1.03	0.28	1	0	0.56	1.55
1.38	0.30	1	0	0.56	1.45
2.07	0.34	1	0	0.56	1.31
3.45	0.38	1	0	0.56	1.15
5.17	0.42	1	0	0.56	1.04
6.89	0.44	1	0	0.56	1.00

Static Equivalent Load

$$\frac{F_a}{F_r} > 0.8, P_0 = 0.6F_r + 0.5F_a$$

$$\frac{F_a}{F_r} \leq 0.8, P_0 = F_r$$

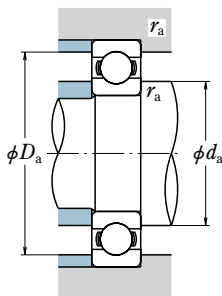

Abutment and Fillet Dimensions (mm)			Mass (kg)
d_a	D_a	r_a max.	approx.
127	142	1	0.53
132	155	1	1.21
130	171	1	1.6
135	167	2	2.08
137	199	2	5.29
139	242	2.5	12.5
140	192	2	4.16
138	155	1	0.75
144	168	1.5	1.57
142	189	1	2.4
145	187	2	3.26
149	212	2.5	5.96
152	258	3	15.2
148	165	1	0.83
154	178	1.5	1.67
153	199	1	2.84
155	196	2	3.48
160	202	2.5	4.51
160	232	2.5	7.68
163	278	3	18.5
159	179	1	1.15
165	188	1.5	2.08
166	196	2	2.59
163	214	1	3.62
168	209	2	4.24
170	251	2.5	10
173	297	3	22.7
169	189	1	1.23
176	206	2	2.71
175	227	1.5	4.2
178	224	2	5.15
180	271	2.5	12.8
184	317	3	26.2

SINGLE-ROW DEEP GROOVE BALL BEARINGS

Bore Diameter 170 – 205 mm

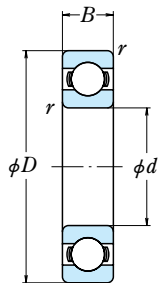

Boundary Dimensions (mm)				Basic Load Ratings (kN)				Factor	Bearing Numbers	Figure ⁽¹⁾
d	D	B	r min.	C_r	C_{0r}	C_r	C_{0r}	f_0		
170	230	28	2	86.0	97.0	8 750	9 850	16.7	6934 B170-12 16034 6034 6234 6334	1
	240	28	2	86.0	97.0	8 750	9 850	16.7		2
	260	28	1.5	114	126	11 700	12 900	16.5		2
	260	42	2.1	161	161	16 400	16 400	15.8		1
	310	52	4	212	224	21 700	22 800	15.3		1
	360	72	4	325	355	33 500	36 000	13.6		2
175	245	32	2	101	115	10 300	11 700	16.6	B175-3 B175-1	2
	290	42	4	195	203	19 800	20 700	15.5		2
180	225	22	1.1	60.5	78.5	6 200	8 000	17.2	6836 6936 B180-2 16036 6036 B180-1 6236 6336	1
	250	33	2	119	128	12 100	13 100	16.4		1
	260	34	2	140	147	14 300	15 000	16.2		2
	280	31	2	145	157	14 700	16 000	16.3		2
	280	46	2.1	180	185	18 400	18 800	15.6		1
	290	42	4	198	205	20 200	20 900	15.4		2
	320	52	4	227	241	23 200	24 600	15.1		1
	380	75	4	355	405	36 000	41 500	13.9		2
190	240	24	1.5	73.0	93.5	7 450	9 550	17.1	6838 6938 16038 6038 B190-2 6238 6338	1
	260	33	2	113	127	11 500	13 000	16.6		2
	290	31	2	149	168	15 200	17 100	16.4		2
	290	46	2.1	188	201	19 200	20 500	15.8		1
	300	42	4	208	224	21 200	22 800	15.5		2
	340	55	4	255	282	26 000	28 700	15.0		2
195	400	78	5	355	415	36 000	42 500	14.1	2	
	265	33	2	113	128	11 500	13 000	16.7	B195-1 B195-2	2
	270	35	2	130	147	13 300	15 000	16.5		2
200	250	20	1	52.5	77.0	5 350	7 900	17.6	B200-3 6840 6940 B200-5 16040 6040 6240 6340	2
	250	24	1.5	74.0	98.0	7 550	10 000	17.2		2
	280	38	2.1	143	158	14 600	16 100	16.4		2
	290	38	2.1	143	158	14 600	16 100	16.4		2
	310	34	2	161	180	16 400	18 300	16.4		2
	310	51	2.1	207	226	21 100	23 000	15.6		1
	360	58	4	269	310	27 400	31 500	15.2		2
	420	80	5	380	445	38 500	45 500	13.8		2
205	285	38	1.1	143	159	14 600	16 200	16.5	B205-1	2

Notes ⁽¹⁾ Refer to page B 5

Dynamic Equivalent Load

$$P = XF_r + YF_a$$

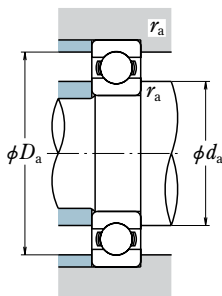

$\frac{f_0 F_r}{C_{0r}}$	e	$\frac{F_a}{F_r} \leq e$		$\frac{F_a}{F_r} > e$	
		X	Y	X	Y
		0.172	0.19	1	0
0.345	0.22	1	0	0.56	1.99
0.689	0.26	1	0	0.56	1.71
1.03	0.28	1	0	0.56	1.55
1.38	0.30	1	0	0.56	1.45
2.07	0.34	1	0	0.56	1.31
3.45	0.38	1	0	0.56	1.15
5.17	0.42	1	0	0.56	1.04
6.89	0.44	1	0	0.56	1.00

Static Equivalent Load

$$\frac{F_a}{F_r} > 0.8, P_0 = 0.6F_r + 0.5F_a$$

$$\frac{F_a}{F_r} \leq 0.8, P_0 = F_r$$

Abutment and Fillet Dimensions (mm)			Mass (kg)
d_a	D_a	r_a max.	
			approx.
187	216	2	2.85
187	226	2	4.11
186	246	1.5	5.71
189	244	2	6.89
194	288	3	15.8
194	337	3	36.6
192	231	2	4.72
199	268	3	11.3
194	214	1	1.72
197	236	2	4.16
197	245	2	6.1
197	265	2	7.5
199	263	2	8.88
204	268	3	10.7
204	297	3	15.9
204	356	3	43.1
202	227	1.5	2.53
207	245	2	5.18
207	275	2	7.78
210	273	2	9.39
215	278	3	11.2
215	317	3	22.3
219	372	4	49.7
213	250	2	5.33
213	255	2	6.11
214	240	1	2.34
212	237	1.5	2.67
220	263	2	7.28
220	273	2	8.54
218	294	2	10
220	293	2	12
225	337	3	26.7
229	392	4	55.3
220	272	1	7.49

SINGLE-ROW DEEP GROOVE BALL BEARINGS

Bore Diameter 210 – 277 mm

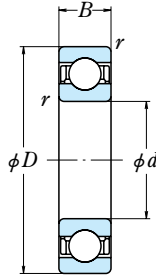

Boundary Dimensions (mm)				Basic Load Ratings (kN)				Factor	Bearing Numbers	Figure ⁽¹⁾
<i>d</i>	<i>D</i>	<i>B</i>	<i>r</i> min.	<i>C_r</i>	<i>C_{0r}</i>	<i>C_r</i>	<i>C_{0r}</i>	<i>f₀</i>		
210	290	38	2.1	148	169	15 100	17 200	16.5	B210-6 B210-3	2
	350	58	3	269	310	27 400	31 500	15.2		2
220	270	24	1.5	76.5	107	7 800	10 900	17.4	6844	2
	300	38	2.1	146	169	14 900	17 300	16.6	6944	2
	340	37	2.1	180	217	18 400	22 100	16.5	16044	2
220	340	56	3	235	271	24 000	27 600	15.6	6044	2
	400	65	4	310	375	31 500	38 500	15.1	6244	2
	460	88	5	410	520	42 000	53 000	14.3	6344	2
	230	310	38	2.1	150	180	15 300	18 300	16.7	B230-8
240	300	28	2	98.5	137	10 000	14 000	17.3	6848	2
	320	38	2.1	154	190	15 700	19 400	16.8	6948	2
	360	37	2.1	196	243	19 900	24 700	16.5	16048	2
240	360	56	3	244	296	24 900	30 000	15.9	6048	2
	390	55	4	279	345	28 500	35 500	15.6	B240-6	2
	440	72	4	340	430	34 500	44 000	15.2	6248	2
	500	95	5	470	625	48 000	63 500	14.2	6348	2
	245	365	45	4	238	293	24 300	29 900	16.0	B245-1
250	305	20	1	62.5	103	6 400	10 500	17.8	B250-8	2
	330	30	1.5	142	185	14 500	18 800	17.0	B250-4	2
	340	35	2.1	158	201	16 100	20 500	16.9	B250-1	2
	340	42	2.1	179	218	18 200	22 200	16.6	B250-7	2
260	320	28	2	101	148	10 300	15 100	17.4	6852	2
	360	46	2.1	204	255	20 800	26 000	16.5	6952	2
	400	44	3	237	310	24 100	31 500	16.4	16052	2
260	400	65	4	291	375	29 700	38 500	15.8	6052	2
	480	80	5	400	540	41 000	55 000	15.1	6252	2
	540	102	6	505	710	51 500	72 500	14.6	6352	2
	277	420	65	4	300	410	31 000	41 500	16.0	B277-1

Notes ⁽¹⁾ Refer to page B 5

Dynamic Equivalent Load

$$P = XF_r + YF_a$$

$\frac{f_0 F_r}{C_{0r}}$	e	$\frac{F_a}{F_r} \leq e$		$\frac{F_a}{F_r} > e$	
		X	Y	X	Y
0.172	0.19	1	0	0.56	2.30
0.345	0.22	1	0	0.56	1.99
0.689	0.26	1	0	0.56	1.71
1.03	0.28	1	0	0.56	1.55
1.38	0.30	1	0	0.56	1.45
2.07	0.34	1	0	0.56	1.31
3.45	0.38	1	0	0.56	1.15
5.17	0.42	1	0	0.56	1.04
6.89	0.44	1	0	0.56	1.00

Static Equivalent Load

$$\frac{F_a}{F_r} > 0.8, P_0 = 0.6F_r + 0.5F_a$$

$$\frac{F_a}{F_r} \leq 0.8, P_0 = F_r$$

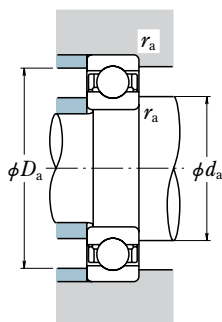

Abutment and Fillet Dimensions (mm)			Mass (kg)
d_a	D_a	r_a max.	
230	273	2	7.53
232	330	2.5	22.5
232	256	1.5	2.9
241	283	2	7.88
241	322	2	13.1
243	320	2.5	18.6
246	376	3	37.4
250	431	4	73.9
251	293	2	8.08
259	285	2	4.48
262	302	2	8.49
262	342	2	13.9
264	340	2.5	19.9
267	366	3	27.2
267	415	3	50.5
271	470	4	94.4
272	342	3	16.6
266	294	1	3.18
269	315	1.5	7.33
272	322	2	9.58
272	322	2	11.1
274	304	2	4.84
282	342	2	14
284	379	2.5	21.1
288	376	3	29.4
292	450	4	67
298	503	5	118
305	395	3	31.8

SINGLE-ROW DEEP GROOVE BALL BEARINGS

Bore Diameter 280 – 365 mm

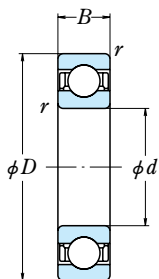

Boundary Dimensions (mm)				Basic Load Ratings (kN) / (kgf)				Factor	Bearing Numbers	Fig- ure ⁽¹⁾
<i>d</i>	<i>D</i>	<i>B</i>	<i>r</i> min.	<i>C_r</i>	<i>C_{0r}</i>	<i>C_r</i>	<i>C_{0r}</i>	<i>f₀</i>		
280	350	33	2	133	191	13 600	19 500	17.3	6856 6956 16056	2 2 2
	380	46	2.1	209	272	21 300	27 700	16.6		
	420	44	3	243	330	24 700	33 500	16.5		
	420	65	4	300	410	31 000	41 500	16.0	6056 B280-6 6256 6356	2 2 2 2
	460	63	4	340	460	34 500	47 000	15.7		
	500	80	5	400	550	41 000	56 000	15.2		
580	108	6	570	840	58 000	86 000	14.5			
300	360	25	2	105	166	10 700	16 900	17.6	B300-7 6860 B300-6	2 2 2
	380	38	2.1	166	233	17 000	23 800	17.1		
	395	35	2.1	183	253	18 700	25 800	17.1		
	420	56	3	269	370	27 400	38 000	16.4	6960 16060 6060 6260	2 2 2 2
	460	50	4	285	405	29 000	41 000	16.4		
	460	74	4	355	500	36 500	51 000	15.8		
540	85	5	465	670	47 500	68 500	15.1			
310	430	56	3	258	365	26 400	37 000	16.5	B310-4 B310-5	2 2
	450	50	4	266	385	27 200	39 000	16.6		
320	400	38	2.1	168	244	17 200	24 900	17.2	6864 6964 16064	2 2 2
	440	56	3	266	375	27 100	38 000	16.5		
	480	50	4	293	430	29 800	44 000	16.5		
	480	74	4	390	570	40 000	58 000	15.7	6064 6264	2 2
	580	92	5	530	805	54 500	82 500	15.0		
340	420	38	2.1	175	265	17 800	27 100	17.3	6868 6968 6068 6268	2 2 2 2
	460	56	3	273	400	27 800	40 500	16.6		
	520	82	5	440	660	45 000	67 500	15.6		
	620	92	6	530	820	54 000	83 500	15.3		
360	440	38	2.1	192	290	19 600	29 600	17.3	6872 6972 6072	2 2 2
	480	56	3	280	425	28 500	43 000	16.7		
	540	82	5	460	720	47 000	73 500	15.7		
	550	85	5	460	720	47 000	73 500	15.8	B360-2 6272	2 2
	650	95	6	555	905	57 000	92 000	15.4		
365	430	20	1.1	70.5	146	7 150	14 900	18.1	B365-1	2

Notes (1) Refer to page B 5

Dynamic Equivalent Load

$$P = XF_r + YF_a$$

$\frac{f_0 F_r}{C_{0r}}$	e	$\frac{F_a}{F_r} \leq e$		$\frac{F_a}{F_r} > e$	
		X	Y	X	Y
0.172	0.19	1	0	0.56	2.30
0.345	0.22	1	0	0.56	1.99
0.689	0.26	1	0	0.56	1.71
1.03	0.28	1	0	0.56	1.55
1.38	0.30	1	0	0.56	1.45
2.07	0.34	1	0	0.56	1.31
3.45	0.38	1	0	0.56	1.15
5.17	0.42	1	0	0.56	1.04
6.89	0.44	1	0	0.56	1.00

Static Equivalent Load

$$\frac{F_a}{F_r} > 0.8, P_0 = 0.6F_r + 0.5F_a$$

$$\frac{F_a}{F_r} \leq 0.8, P_0 = F_r$$

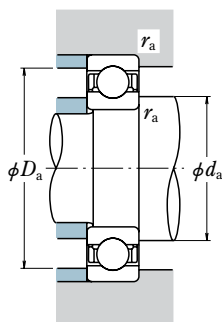

Abutment and Fillet Dimensions (mm)			Mass (kg)
d_a	D_a	r_a max.	
301	334	2	7.2
303	361	2	15.1
305	398	2.5	22.7
308	395	3	31.2
308	435	3	44.5
312	470	4	70.4
319	542	5	144
314	343	2	5.05
324	361	2	10.3
324	376	2	12.1
326	398	2.5	23.9
329	435	3	31.5
329	435	3	44.2
333	509	4	87.8
336	408	2.5	25
340	425	3	27.5
345	381	2	10.8
347	418	2.5	25.3
350	454	3	33.2
350	454	3	46.5
354	548	4	111
358	400	2	11.5
368	438	2.5	26.6
375	490	4	62.3
381	582	5	129
377	420	2	11.8
388	457	2.5	27.9
396	509	4	65.3
396	519	4	72.6
402	611	5	145
387	415	1	5.52

SINGLE-ROW DEEP GROOVE BALL BEARINGS

Bore Diameter 380 – 610 mm

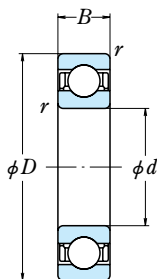

Boundary Dimensions (mm)				Basic Load Ratings				Factor	Bearing Numbers	Fig-ure ⁽¹⁾	
<i>d</i>	<i>D</i>	<i>B</i>	<i>r</i> min.	<i>C_r</i> (kN)	<i>C_{0r}</i>	<i>C_r</i> (kgf)	<i>C_{0r}</i>	<i>f₀</i>			
380	480	46	2.1	238	375	24 200	38 000	17.1	6876	2	
	520	65	4	325	510	33 000	52 000	16.6		6976	2
	560	82	5	455	725	46 500	74 000	15.9		6076	2
390	490	46	2.1	236	375	24 100	38 500	17.2	B390-2	3	
400	500	46	2.1	241	390	24 600	40 000	17.2	6880	2	
	540	65	4	335	540	34 000	55 000	16.7	6980	2	
	600	90	5	510	825	52 000	84 000	15.7	6080	2	
420	520	46	2.1	245	410	25 000	41 500	17.3	6884	2	
	560	65	4	340	570	35 000	58 500	16.8	6984	2	
	620	90	5	530	895	54 000	91 000	15.8	6084	2	
440	540	46	2.1	248	425	25 300	43 500	17.4	6888	2	
	600	74	4	395	680	40 500	69 000	16.6	6988	2	
	650	94	6	550	965	56 000	98 500	16.0	6088	2	
460	580	56	3	310	550	31 500	56 000	17.1	6892	2	
	620	74	4	405	720	41 500	73 500	16.7	6992	2	
	680	100	6	605	1 080	62 000	110 000	15.8	6092	2	
480	600	56	3	315	575	32 000	58 500	17.2	6896	2	
	650	78	5	450	815	45 500	83 000	16.6	6996	2	
	700	100	6	605	1 090	61 500	111 000	15.9	6096	2	
484	660	80	5	480	855	49 000	87 500	16.4	B484-1	2	
500	620	56	3	320	600	33 000	61 000	17.3	68/500	2	
	670	78	5	460	865	47 000	88 000	16.7	69/500	2	
	720	100	6	630	1 170	64 000	120 000	16.0	60/500	2	
530	650	56	3	325	625	33 000	63 500	17.4	68/530	3	
	710	82	5	455	870	46 500	88 500	16.8	69/530	3	
	780	112	6	680	1 300	69 500	133 000	16.0	60/530	2	
560	680	56	3	330	650	33 500	66 500	17.4	68/560	2	
	750	85	5	525	1 040	53 500	106 000	16.7	69/560	2	
600	730	60	3	355	735	36 000	75 000	17.5	68/600	2	
	800	90	5	550	1 160	56 500	118 000	16.9	69/600	2	
	870	118	6	790	1 640	80 500	168 000	16.1	60/600	2	
610	730	54	3	335	700	34 500	71 500	17.5	B610-2	3	

Notes ⁽¹⁾ Refer to page B 5

Dynamic Equivalent Load

$$P = X F_r + Y F_a$$

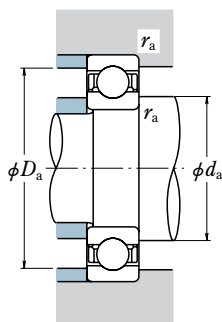

$\frac{f_0 F_r}{C_{0r}}$	e	$\frac{F_a}{F_r} \leq e$		$\frac{F_a}{F_r} > e$	
		X	Y	X	Y
		0.172	0.19	1	0
0.345	0.22	1	0	0.56	1.99
0.689	0.26	1	0	0.56	1.71
1.03	0.28	1	0	0.56	1.55
1.38	0.30	1	0	0.56	1.45
2.07	0.34	1	0	0.56	1.31
3.45	0.38	1	0	0.56	1.15
5.17	0.42	1	0	0.56	1.04
6.89	0.44	1	0	0.56	1.00

Static Equivalent Load

$$\frac{F_a}{F_r} > 0.8, P_0 = 0.6 F_r + 0.5 F_a$$

$$\frac{F_a}{F_r} \leq 0.8, P_0 = F_r$$

Abutment and Fillet Dimensions (mm)			Mass (kg)
d_a	D_a	r_a max.	approx.
407	459	2	19.5
412	493	3	40
416	529	4	68
418	469	2	20
428	479	2	20.5
433	513	3	42
437	568	4	88.4
449	498	2	21.4
454	533	3	43.6
458	588	4	92.2
470	518	2	22.3
475	572	3	60.2
485	611	5	106
492	555	2.5	34.3
496	591	3	62.6
506	640	5	123
513	575	2.5	35.4
520	617	4	73.5
527	660	5	127
525	627	4	78.1
534	594	2.5	37.2
541	637	4	82
548	680	5	131
565	624	2.5	39.8
572	676	4	89.8
579	738	5	184
596	653	2.5	41.5
604	715	4	105
638	702	2.5	50.9
645	764	4	120
652	827	5	236
635	702	2.5	43

SINGLE-ROW DEEP GROOVE BALL BEARINGS

Bore Diameter 630 – 1 100 mm

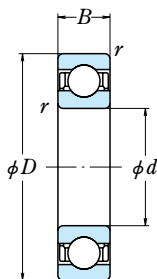

Boundary Dimensions (mm)				Basic Load Ratings				Factor	Bearing Numbers	Figure ⁽¹⁾
<i>d</i>	<i>D</i>	<i>B</i>	<i>r</i> min.	(kN)		(kgf)		<i>f</i> ₀		
630	780	69	4	420	890	43 000	90 500	17.3	68/630 69/630 60/630	2
	850	100	6	625	1 350	64 000	138 000	16.7		2
	920	128	7.5	750	1 620	76 500	165 000	16.4		2
640	740	38	2.1	248	535	25 200	54 500	17.9	B640-2	2
670	820	69	4	435	965	44 500	98 000	17.4	68/670 69/670 60/670	2
	900	103	6	675	1 460	68 500	149 000	16.7		2
	980	136	7.5	765	1 730	78 000	177 000	16.6		2
680	790	50	3	288	650	29 400	66 500	17.9	B680-3	2
710	870	74	4	480	1 100	49 000	113 000	17.4	68/710 69/710 60/710	2
	950	106	6	715	1 640	72 500	167 000	16.8		2
	1 030	140	7.5	1 020	2 310	104 000	235 000	16.0		2
730	900	78	5	505	1 160	51 500	119 000	17.3	B730-1	3
750	920	78	5	525	1 260	53 500	128 000	17.4	68/750 69/750MA	2
	1 000	112	6	785	1 840	80 000	188 000	16.7		2
770	940	78	5	525	1 260	53 500	128 000	17.4	B770-2	3
800	980	82	5	530	1 310	54 000	133 000	17.5	68/800 69/800	3
	1 060	115	6	825	2 050	84 500	209 000	16.8		2
880	1 130	115	5	810	2 070	82 500	211 000	17.0	B880-3	3
930	1 010	40	2.1	174	540	17 800	55 000	18.4	B930-1 B930-51	2
	1 250	95	6	795	2 190	81 000	224 000	17.3		2
940	1 140	100	5	685	1 820	70 000	186 000	17.4	B940-1	2
945	1 150	90	5	615	1 660	63 000	169 000	17.5	B945-3	3
1 100	1 200	50	2.1	253	795	25 800	81 000	18.4	B1100-3	2

Notes ⁽¹⁾ Refer to page B 5

Dynamic Equivalent Load

$$P = X F_r + Y F_a$$

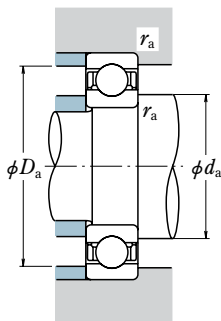

Static Equivalent Load

$$\frac{F_a}{F_r} > 0.8, P_0 = 0.6 F_r + 0.5 F_a$$

$$\frac{F_a}{F_r} \leq 0.8, P_0 = F_r$$

$\frac{f_0 F_r}{C_{0r}}$	e	$\frac{F_a}{F_r} \leq e$		$\frac{F_a}{F_r} > e$	
		X	Y	X	Y
0.172	0.19	1	0	0.56	2.30
0.345	0.22	1	0	0.56	1.99
0.689	0.26	1	0	0.56	1.71
1.03	0.28	1	0	0.56	1.55
1.38	0.30	1	0	0.56	1.45
2.07	0.34	1	0	0.56	1.31
3.45	0.38	1	0	0.56	1.15
5.17	0.42	1	0	0.56	1.04
6.89	0.44	1	0	0.56	1.00

Abutment and Fillet Dimensions (mm)			Mass (kg)
d_a	D_a	r_a max.	
672	748	3	71.3
683	807	5	163
689	870	6	285
662	714	2	26.8
714	787	3	75.4
724	856	5	181
731	929	6	351
704	761	2.5	40.8
756	836	3	92.6
766	905	5	208
772	978	6	386
780	862	4	107
801	882	4	110
808	954	5	245
822	901	4	112
853	940	4	132
860	1 013	5	275
936	1 087	4	290
949	991	2	30.6
995	1 199	5	350
999	1 097	4	209
1 004	1 107	4	194
1 123	1 165	2	57.4

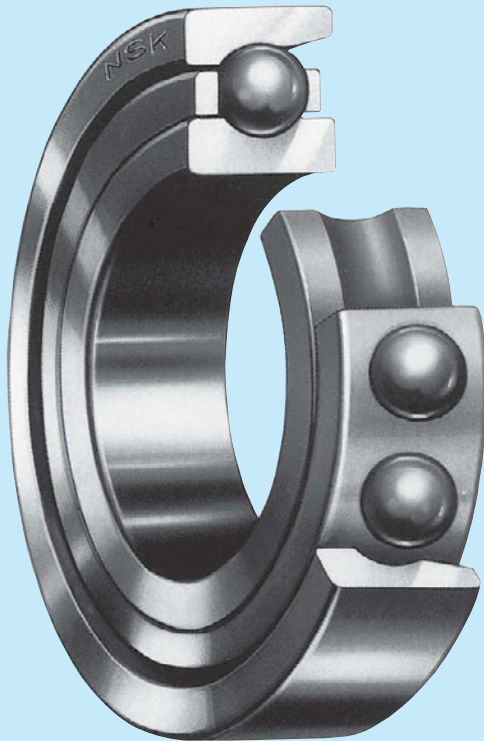

ANGULAR CONTACT BALL BEARINGS

Single-Row and Matched Angular Contact Ball Bearings

Bore Diameter 90 – 775mm..... B24

Double-Row Angular Contact Ball Bearings

Angular Contact Ball Bearings

Bore Diameter 100 – 280mm..... B42

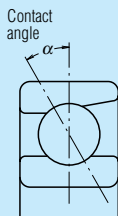

Design, Types, and Features

Single-Row Angular Contact Ball Bearings

Since these bearings have a contact angle, they can sustain significant axial loads in one direction together with radial loads. Because of their design, when a radial load is applied, an axial force component is produced; therefore, two opposed bearings or a combination of more than two must be used.

Usually, the cages for large-size angular contact ball bearings are machined brass and guided by the inner ring (Figures 1 and 2) or the balls (Figures 3 and 4).

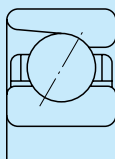

Figure 1

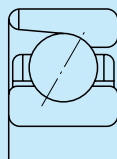

Figure 2

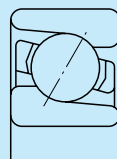

Figure 3

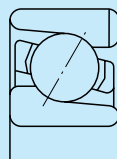

Figure 4

Table 1 Types and Features of Matched Angular Contact Ball Bearings

Figure	Arrangement	Features
	Back-to-back (DB) (Example) 7220 A DB	Radial loads and axial loads in both directions can be sustained. Since the distance between the effective load centers a_0 is big, this type is suitable if moments are applied.
	Face-to-face (DF) (Example) 7220 B DF	Radial loads and axial loads in both directions can be sustained. Compared with the DB Type, the distance between the effective load centers is small, so the capacity to sustain moments is inferior to the DB Type.

Remarks Regarding the tandem arrangement (DT), please contact **NSK**.

Regarding the angular contact ball bearings used with four-row cylindrical roller bearings for roll necks, refer to page B418.

Double-Row Angular Contact Ball Bearings

This is basically a back-to-back or face-to-face arrangement of two single-row angular contact ball bearings, but their inner or outer rings are integrated into one. Axial loads in both directions can be sustained, so these bearings are used as fixed-end bearings.

Cross-sections of double-row angular contact ball bearings are shown below. The bearings in Figures 5 and 7 have good capacity to sustain moments.

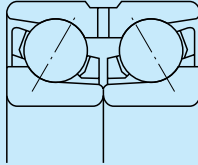

Figure 5

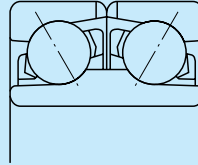

Figure 6

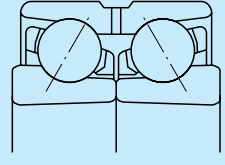

Figure 7

Tolerances and Running Accuracy.....Table 2.2 (Pages A16 to A19)

**Single-Row
Angular Contact Ball Bearings**

**Matched
Angular Contact Ball Bearings**

**Double-Row
Angular Contact Ball Bearings**

Recommended FitsTable 3.2 (Page A35)
Table 3.4 (Page A36)

**Single-Row
Angular Contact Ball Bearings**

**Matched
Angular Contact Ball Bearings**

**Double-Row
Angular Contact Ball Bearings**

Internal Clearances

**Matched
Angular Contact Ball Bearings**Table 3.14 (Page A44)

**Double-Row
Angular Contact Ball Bearings**Please contact NSK.

Precautions for Use of Angular Contact Ball Bearings

If the load on angular contact ball bearings becomes too small, or if the ratio of the axial and radial loads for matched bearings exceeds ' e ' (e is listed in the bearings tables) during operation, slippage between the balls and raceways occurs, which may result in smearing. Especially with large bearings since the weight of the balls and cage is high. If such load conditions are expected, please consult with **NSK** for selection of the bearings.

ANGULAR CONTACT BALL BEARINGS

SINGLE/MATCHED

Bore Diameter 90 – 105 mm

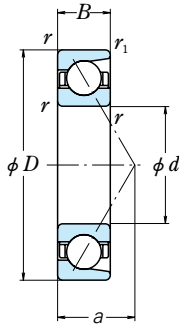

Single

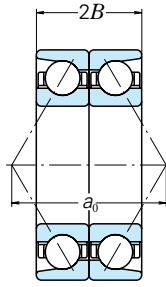

Back-to-Back
DB

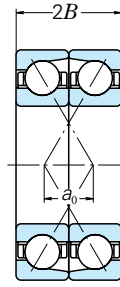

Front-to-Front
DF

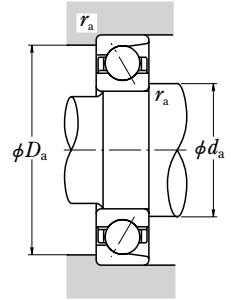

Boundary Dimensions (mm)					Basic Load Ratings (Single)				Eff. Load Centers (mm)	Abutment and Fillet Dimensions (mm)			Bearing Numbers ⁽¹⁾		
d	D	B	r min.	r_1 min.	C_r	C_{0r}	C_r	C_{0r}		a	d_a	D_a	r_a max.	Single	Matched
90	140	24	1.5	1	65.0	63.5	6 650	6 450	45.2	103	128	1.5	7018A	DB DF	
	140	24	1.5	1	58.5	57.0	5 950	5 800	60.2	103	128	1.5	7018B	DB DF	
	160	30	2	1	113	96.5	11 500	9 850	51.1	104	147	2	7218A	DB DF	
	160	30	2	1	113	96.5	11 500	9 850	51.1	104	147	2	7218AA	DB DF	
	160	30	2	1	102	88.0	10 400	8 950	67.4	104	147	2	7218B	DB DF	
	160	30	2	1	102	88.0	10 400	8 950	67.4	104	147	2	7218BA	DB DF	
	190	43	3	1.1	161	135	16 400	13 700	61.9	109	172	2.5	7318A	DB DF	
	190	43	3	1.1	148	124	15 000	12 600	80.2	109	172	2.5	7318B	DB DF	
	95	145	24	1.5	1	67.0	67.0	6 800	6 800	46.6	109	133	1.5	7019A	DB DF
		145	24	1.5	1	60.0	60.5	6 100	6 150	62.3	109	133	1.5	7019B	DB DF
		170	32	2.1	1.1	122	103	12 500	10 500	54.2	112	154	2	7219A	DB DF
		170	32	2.1	1.1	111	94.0	11 300	9 600	71.6	112	154	2	7219B	DB DF
200		45	3	1.1	172	149	17 600	15 200	65.1	114	182	2.5	7319A	DB DF	
200		45	3	1.1	158	137	16 100	13 900	84.3	114	182	2.5	7319B	DB DF	
200		45	3	1.1	158	137	16 100	13 900	84.3	114	182	2.5	7319BA	DB DF	
100		150	24	1.5	1	68.5	70.5	6 950	7 200	48.1	114	138	1.5	7020A	DB DF
	150	24	1.5	1	61.0	63.5	6 250	6 500	64.4	114	138	1.5	7020B	DB DF	
	180	34	2.1	1.1	137	117	14 000	12 000	57.4	117	164	2	7220A	DB DF	
	180	34	2.1	1.1	137	117	14 000	12 000	57.4	117	164	2	7220AA	DB DF	
	180	34	2.1	1.1	124	107	12 700	10 900	75.7	117	164	2	7220B	DB DF	
	215	47	3	1.1	207	193	21 100	19 700	69.0	119	196	2.5	7320A	DB DF	
	215	47	3	1.1	207	193	21 100	19 700	69.0	119	196	2.5	7320AA	DB DF	
	215	47	3	1.1	190	178	19 400	18 100	89.6	119	196	2.5	7320B	DB DF	
	105	160	26	2	1	80.0	81.5	8 150	8 350	51.2	120	147	2	7021A	DB DF
		160	26	2	1	71.5	73.5	7 300	7 500	68.6	120	147	2	7021B	DB DF
		190	36	2.1	1.1	150	132	15 200	13 500	60.6	122	174	2	7221A	DB DF
		190	36	2.1	1.1	136	120	13 800	12 300	79.9	122	174	2	7221B	DB DF
225		49	3	1.1	208	193	21 200	19 700	72.1	124	206	2.5	7321A	DB DF	
225		49	3	1.1	191	177	19 400	18 100	93.7	124	206	2.5	7321B	DB DF	

Note ⁽¹⁾ The suffixes A, AA and B, BA represent contact angles of 30° and 40° respectively.

Dynamic Equivalent Load $P = XF_r + YF_a$

Contact Angle	e	Single				DB or DF			
		$F_a/F_r \leq e$		$F_a/F_r > e$		$F_a/F_r \leq e$		$F_a/F_r > e$	
		X	Y	X	Y	X	Y	X	Y
30°	0.80	1	0	0.39	0.76	1	0.78	0.63	1.24
40°	1.14	1	0	0.35	0.57	1	0.55	0.57	0.93

Static Equivalent Load $P_0 = X_0F_r + Y_0F_a$

Contact Angle	Single		DB or DF		Single mounting When $F_r > 0.5F_r + Y_0F_a$ use $P_0 = F_r$
	X_0	Y_0	X_0	Y_0	
30°	0.5	0.33	1	0.66	
40°	0.5	0.26	1	0.52	

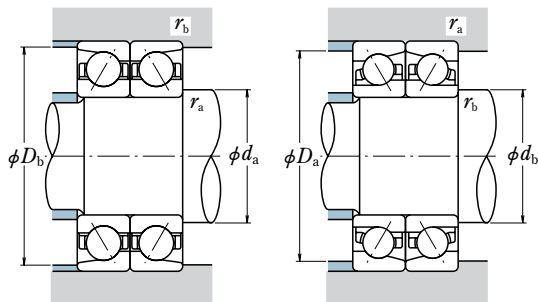

Fig- ure ⁽²⁾	Basic Load Ratings (Matched)				Load Center Spacings (mm)		Abutment and Fillet Dimensions (mm)			Mass (kg)
	(kN)		(kgf)		DB	DF	$d_b^{(3)}$	D_b	$r_b^{(3)}$ max.	
	C_r	C_{0r}	C_r	C_{0r}						
1	106	127	10 800	12 900	90.4	42.4	—	131	1	1.35
1	95.0	114	9 700	11 600	120.5	72.5	—	131	1	1.37
1	183	193	18 700	19 700	102.2	42.2	—	150	1	2.54
3	183	193	18 700	19 700	102.2	42.2	100	150	1	2.42
1	166	176	16 900	17 900	134.9	74.9	—	150	1	2.56
3	166	176	16 900	17 900	134.9	74.9	100	150	1	2.56
1	261	270	26 700	27 500	123.8	37.8	—	179	1	5.79
1	240	248	24 400	25 300	160.5	74.5	—	179	1	5.86
1	109	134	11 100	13 600	93.3	45.3	—	136	1	1.43
1	97.0	121	9 900	12 300	124.7	76.7	—	136	1	1.42
1	198	207	20 200	21 100	108.5	44.5	—	159	1	3.08
1	180	188	18 300	19 200	143.2	79.2	—	159	1	3.09
1	280	298	28 500	30 500	130.2	40.2	—	189	1	6.6
1	257	273	26 200	27 900	168.7	78.7	—	189	1	6.68
3	257	273	26 200	27 900	168.7	78.7	107	189	1	6.56
1	111	141	11 300	14 400	96.2	48.2	—	141	1	1.48
1	99.5	127	10 100	13 000	128.9	80.9	—	141	1	1.49
1	223	234	22 700	23 900	114.8	46.8	—	169	1	3.68
3	223	234	22 700	23 900	114.8	46.8	112	169	1	3.5
1	202	214	20 600	21 800	151.5	83.5	—	169	1	3.7
1	335	385	34 500	39 500	137.9	43.9	—	203	1	8.27
3	335	385	34 500	39 500	137.9	43.9	112	203	1	7.87
1	310	355	31 500	36 000	179.2	85.2	—	203	1	8.32
1	130	163	13 300	16 700	102.5	50.5	—	150	1	1.84
1	116	147	11 900	15 000	137.2	85.2	—	150	1	1.87
1	243	264	24 800	26 900	121.2	49.2	—	179	1	4.38
1	220	241	22 500	24 500	159.8	87.8	—	179	1	4.4
1	335	385	34 500	39 500	144.3	46.3	—	213	1	9.34
1	310	355	31 500	36 000	187.4	89.4	—	213	1	9.44

Notes ⁽²⁾ Refer to page B 21

⁽³⁾ For bearings marked — in the column for d_b , D_b and r_b for shafts are d_a and r_a (max.) respectively.

ANGULAR CONTACT BALL BEARINGS

SINGLE/MATCHED

Bore Diameter 110 – 130 mm

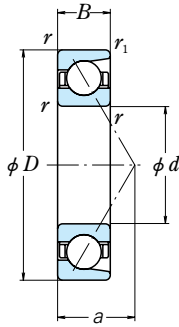

Single

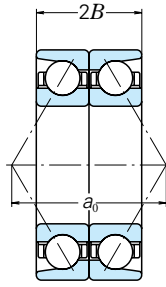

Back-to-Back
DB

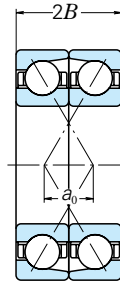

Front-to-Front
DF

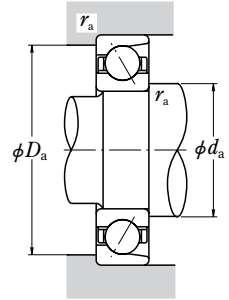

	Boundary Dimensions (mm)				Basic Load Ratings (Single)				Eff. Load Centers (mm) <i>a</i>	Abutment and Fillet Dimensions (mm)			Bearing Numbers (1)		
	<i>d</i>	<i>D</i>	<i>B</i>	<i>r</i> <i>r</i> _{min.}	<i>r</i> ₁ <i>r</i> _{min.}	<i>C_r</i>	<i>C</i> _{0r}	<i>C_r</i>		<i>C</i> _{0r}	<i>d</i> _a	<i>D</i> _a	<i>r</i> _a <i>r</i> _{max.}	Single	Matched
110	170	28	2	1	96.5	95.5	9 850	9 700	54.4	125	156	2	7022A	DB DF	
	170	28	2	1	86.5	86.0	8 850	8 750	72.7	125	156	2	7022B	DB DF	
	200	38	2.1	1.1	162	148	16 500	15 100	63.7	127	184	2	7222A	DB DF	
	200	38	2.1	1.1	162	148	16 500	15 100	63.7	127	184	2	7222AA	DB DF	
	200	38	2.1	1.1	147	135	15 000	13 700	84.0	127	184	2	7222B	DB DF	
	240	50	3	1.1	220	215	22 500	21 900	75.5	129	221	2.5	7322A	DB DF	
	240	50	3	1.1	220	215	22 500	21 900	75.5	129	221	2.5	7322AA	DB DF	
	240	50	3	1.1	201	197	20 500	20 100	98.4	129	221	2.5	7322B	DB DF	
	240	50	3	1.1	201	197	20 500	20 100	98.4	129	221	2.5	7322BA	DB DF	
	120	180	28	2	1	102	107	10 400	10 900	57.3	136	166	2	7024A	DB DF
		180	28	2	1	102	107	10 400	10 900	57.3	136	166	2	7024AA	DB DF
		180	28	2	1	91.5	96.0	9 300	9 800	76.9	136	166	2	7024B	DB DF
215		38	2.1	1.1	169	161	17 200	16 500	67.4	138	198	2	BA120-3	DB —	
215		40	2.1	1.1	183	177	18 600	18 100	68.3	138	198	2	7224A	DB DF	
215		40	2.1	1.1	165	162	16 900	16 500	90.3	138	198	2	7224B	DB DF	
220		40	2	1.1	152	147	15 500	15 000	91.3	136	205	2	BT120-1	DB —	
260		55	3	1.1	246	252	25 100	25 700	82.3	140	241	2.5	7324A	DB DF	
260		55	3	1.1	225	231	23 000	23 600	107.2	140	241	2.5	7324B	DB DF	
260		55	3	1.1	225	231	23 000	23 600	107.2	140	241	2.5	7324BA	DB DF	
130		200	33	2	1	117	125	12 000	12 800	64.1	146	186	2	7026A	DB DF
		200	33	2	1	117	125	12 000	12 800	64.1	146	186	2	7026AA	DB DF
	200	33	2	1	105	113	10 700	11 500	85.7	146	186	2	7026B	DB DF	
	230	40	3	1.1	189	193	19 300	19 600	72.0	150	211	2.5	7226A	DB DF	
	230	40	3	1.1	171	175	17 400	17 800	95.5	150	211	2.5	7226B	DB DF	
	230	40	3	1.1	171	175	17 400	17 800	95.5	150	211	2.5	7226BA	DB DF	
	250	45	3	2	208	218	21 200	22 200	102.2	150	231	2.5	BT130-1	DB —	
	280	58	4	1.5	273	293	27 900	29 800	88.2	154	256	3	7326A	DB DF	
	280	58	4	1.5	273	293	27 900	29 800	88.2	154	256	3	7326AA	DB DF	
	280	58	4	1.5	250	268	25 500	27 400	115.0	154	256	3	7326B	DB DF	
	280	58	4	1.5	250	268	25 500	27 400	115.0	154	256	3	7326BA	DB DF	

Notes (1) The suffixes A, AA and B, BA represent contact angles of 30° and 40° respectively.

Dynamic Equivalent Load $P = XF_r + YF_a$

Contact Angle	e	Single				DB or DF			
		$F_a/F_r \leq e$		$F_a/F_r > e$		$F_a/F_r \leq e$		$F_a/F_r > e$	
		X	Y	X	Y	X	Y	X	Y
30°	0.80	1	0	0.39	0.76	1	0.78	0.63	1.24
40°	1.14	1	0	0.35	0.57	1	0.55	0.57	0.93

Static Equivalent Load $P_0 = X_0F_r + Y_0F_a$

Contact Angle	Single		DB or DF		Single mounting When $F_r > 0.5F_r + Y_0F_a$ use $P_0 = F_r$
	X_0	Y_0	X_0	Y_0	
30°	0.5	0.33	1	0.66	
40°	0.5	0.26	1	0.52	

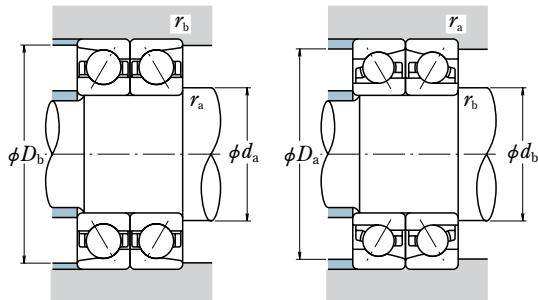

Fig-ure ⁽²⁾	Basic Load Ratings (Matched)				Load Center Spacings (mm)		Abutment and Fillet Dimensions (mm)			Mass (kg)
	(kN)		(kgf)		DB	DF	$d_b^{(3)}$	D_b	$r_b^{(3)}$ max.	
	C_r	C_{0r}	C_r	C_{0r}	a_0	DF	$d_b^{(3)}$	D_b	$r_b^{(3)}$ max.	approx.
1	157	191	16 000	19 400	108.8	52.8	—	160	1	2.28
1	141	172	14 300	17 500	145.5	89.5	—	160	1	2.3
1	263	296	26 800	30 000	127.5	51.5	—	189	1	5.15
3	263	296	26 800	30 000	127.5	51.5	122	189	1	4.89
1	239	269	24 300	27 500	168.1	92.1	—	189	1	5.18
1	360	430	36 500	44 000	151.0	51.0	—	228	1	11.1
3	360	430	36 500	44 000	151.0	51.0	122	228	1	11.2
1	325	395	33 500	40 000	196.8	96.8	—	228	1	11.2
3	325	395	33 500	40 000	196.8	96.8	122	228	1	11
1	166	213	16 900	21 700	114.6	58.6	—	170	1	2.45
3	166	213	16 900	21 700	114.6	58.6	132	170	1	2.33
1	148	192	15 100	19 600	153.9	97.9	—	170	1	2.47
1	274	325	27 900	33 000	134.7	—	—	203	1	12
1	297	355	30 500	36 000	136.7	56.7	—	203	1	6.22
1	269	325	27 400	33 000	180.5	100.5	—	203	1	6.26
1	247	294	25 200	30 000	182.6	—	—	208	1	6.77
1	400	505	41 000	51 500	164.7	54.7	—	247	1	14.5
1	365	460	37 500	47 000	214.4	104.4	—	247	1	14.4
3	365	460	37 500	47 000	214.4	104.4	133	247	1	14.1
1	191	251	19 400	25 600	128.3	62.3	—	190	1	3.68
3	191	251	19 400	25 600	128.3	62.3	142	190	1	3.61
1	171	226	17 400	23 100	171.5	105.5	—	190	1	3.83
1	310	385	31 500	39 500	143.9	63.9	—	218	1	7.06
1	278	350	28 300	35 500	191.0	111.0	—	218	1	7.1
3	278	350	28 300	35 500	191.0	111.0	143	218	1	6.9
1	340	435	34 500	44 500	204.4	—	—	235	2	9.98
1	445	585	45 500	59 500	176.3	60.3	—	265	1.5	17.5
3	445	585	45 500	59 500	176.3	60.3	145	265	1.5	17.2
1	405	535	41 500	54 500	230.0	114.0	—	265	1.5	17.6
3	405	535	41 500	54 500	230.0	114.0	145	265	1.5	17.2

Notes ⁽²⁾ Refer to page B 21

⁽³⁾ For bearings marked — in the column for d_b , D_b and r_b for shafts are d_a and $r_a(max.)$ respectively.

ANGULAR CONTACT BALL BEARINGS

SINGLE/MATCHED

Bore Diameter 140 – 150 mm

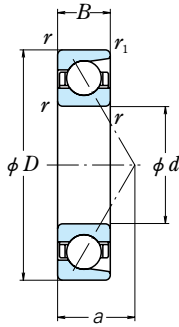

Single

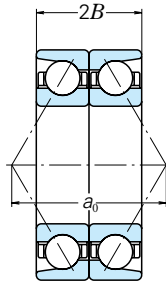

Back-to-Back
DB

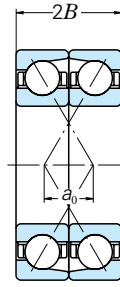

Front-to-Front
DF

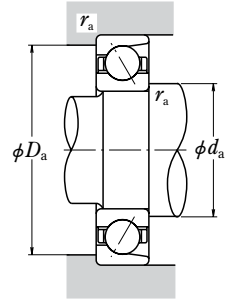

Boundary Dimensions (mm)					Basic Load Ratings (Single) (kN) (kgf)				Eff. Load Centers (mm) a	Abutment and Fillet Dimensions (mm)			Bearing Numbers (1)	
d	D	B	r min.	r_1 min.	C_r	C_{0r}	C_r	C_{0r}		d_a	D_a	r_a max.	Single	Matched
140	175	18	1.1	0.6	47.5	65.0	4 800	6 650	54.5	153	164	1	7828A	DB DF
	175	18	1.1	0.6	42.0	58.0	4 300	5 900	75.1	153	164	1	7828B	DB DF
	190	24	1.5	1	72.0	86.5	7 350	8 850	59.6	155	177	1.5	7928A	DB DF
	190	24	1.5	1	64.0	77.5	6 500	7 900	81.2	155	177	1.5	7928B	DB DF
	210	33	2	1	120	133	12 200	13 500	67.0	156	196	2	7028A	DB DF
	210	33	2	1	107	119	10 900	12 200	89.9	156	196	2	7028B	DB DF
	250	42	3	1.1	218	234	22 300	23 900	77.3	161	231	2.5	7228A	DB DF
	250	42	3	1.1	197	213	20 100	21 700	102.8	161	231	2.5	7228B	DB DF
	300	62	4	1.5	300	335	30 500	34 500	94.5	165	276	3	7328A	DB DF
	300	62	4	1.5	300	335	30 500	34 500	94.5	165	276	3	7328AA	DB DF
	300	62	4	1.5	275	310	28 100	31 500	123.3	165	276	3	7328B	DB DF
	300	62	4	1.5	275	310	28 100	31 500	123.3	165	276	3	7328BA	DB DF
150	190	20	1.1	0.6	53.5	74.5	5 450	7 600	59.1	164	179	1	7830A	DB DF
	190	20	1.1	0.6	47.5	66.5	4 850	6 800	81.3	164	179	1	7830B	DB DF
	210	28	2	1	82.0	104	8 350	10 600	64.5	167	196	2	BA150-6	DB —
	210	28	2	1	92.5	111	9 400	11 300	66.0	167	196	2	7930A	DB DF
	210	28	2	1	82.5	99.5	8 400	10 100	89.5	167	196	2	7930B	DB DF
	225	35	2.1	1.1	137	154	14 000	15 700	71.6	169	208	2	7030A	DB DF
	225	35	2.1	1.1	137	154	14 000	15 700	71.6	169	208	2	7030AA	DB DF
	225	35	2.1	1.1	122	138	12 500	14 100	96.2	169	208	2	7030B	DB DF
	225	35	2.1	1.1	122	138	12 500	14 100	96.2	169	208	2	7030BA	DB DF
	270	45	3	1.1	248	280	25 300	28 500	83.1	171	250	2.5	7230A	DB DF
	270	45	3	1.1	225	254	22 900	25 900	110.6	171	250	2.5	7230B	DB DF
	320	65	4	1.5	315	370	32 500	38 000	100.3	175	295	3	7330A	DB DF
	320	65	4	1.5	289	340	29 400	34 500	131.1	175	295	3	7330B	DB DF
	320	65	4	1.5	289	340	29 400	34 500	131.1	175	295	3	7330BA	DB DF

Notes (1) The suffixes A, AA and B, BA represent contact angles of 30° and 40° respectively.

Dynamic Equivalent Load $P = X F_r + Y F_a$

Contact Angle	e	Single				DB or DF			
		$F_a/F_r \leq e$		$F_a/F_r > e$		$F_a/F_r \leq e$		$F_a/F_r > e$	
		X	Y	X	Y	X	Y	X	Y
30°	0.80	1	0	0.39	0.76	1	0.78	0.63	1.24
40°	1.14	1	0	0.35	0.57	1	0.55	0.57	0.93

Static Equivalent Load $P_0 = X_0 F_r + Y_0 F_a$

Contact Angle	Single		DB or DF		Single mounting When $F_r > 0.5 F_r + Y_0 F_a$ use $P_0 = F_r$
	X_0	Y_0	X_0	Y_0	
30°	0.5	0.33	1	0.66	
40°	0.5	0.26	1	0.52	

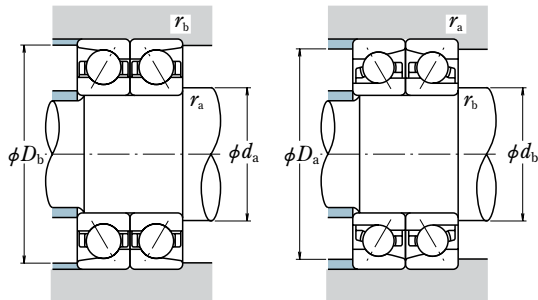

Fig-ure ⁽²⁾	Basic Load Ratings (Matched)				Load Center Spacings (mm)		Abutment and Fillet Dimensions (mm)			Mass (kg)
	(kN)		(kgf)		DB	DF	$d_b^{(3)}$	D_b	$r_b^{(3)}$ max.	
	C_r	C_{0r}	C_r	C_{0r}						
1	77.0	130	7 850	13 300	108.9	72.9	—	166	0.6	0.95
1	68.0	116	6 950	11 800	150.2	114.2	—	166	0.6	0.95
1	117	173	11 900	17 700	119.3	71.3	—	180	1	1.92
1	104	155	10 600	15 800	162.5	114.5	—	180	1	1.95
1	194	265	19 800	27 000	134.0	68.0	—	199	1	3.9
1	174	239	17 700	24 400	179.8	113.8	—	199	1	3.96
1	355	470	36 000	48 000	154.6	70.6	—	238	1	8.92
1	320	425	32 500	43 500	205.6	121.6	—	238	1	8.94
1	490	670	50 000	68 500	189.0	65.0	—	285	1.5	21.4
3	490	670	50 000	68 500	189.0	65.0	155	285	1.5	21
1	445	615	45 500	63 000	246.6	122.6	—	285	1.5	21.6
3	445	615	45 500	63 000	246.6	122.6	155	285	1.5	20.3
1	87.0	149	8 850	15 200	118.1	78.1	—	181	0.6	1.32
1	77.0	133	7 850	13 600	162.6	122.6	—	181	0.6	1.3
4	133	208	13 600	21 200	128.9	—	—	199	1	5.38
1	150	222	15 300	22 600	131.9	75.9	—	199	1	2.99
1	134	199	13 600	20 300	179.0	123.0	—	199	1	2.95
1	222	305	22 700	31 500	143.3	73.3	—	213	1	4.75
3	222	305	22 700	31 500	143.3	73.3	164	213	1	4.59
1	199	277	20 300	28 200	192.3	122.3	—	213	1	4.76
3	199	277	20 300	28 200	192.3	122.3	164	213	1	4.58
1	405	560	41 000	57 000	166.3	76.3	—	257	1	11.2
1	365	510	57 000	52 000	221.2	131.2	—	257	1	11.2
1	515	745	52 500	75 500	200.7	70.7	—	304	1.5	26
1	470	680	48 000	69 500	262.2	132.2	—	304	1.5	25.9
3	470	680	48 000	69 500	262.2	132.2	166	304	1.5	25.4

Notes ⁽²⁾ Refer to page B 21

⁽³⁾ For bearings marked — in the column for d_b , D_b and r_b for shafts are d_a and $r_a(max.)$ respectively.

ANGULAR CONTACT BALL BEARINGS

SINGLE/MATCHED

Bore Diameter 160 – 170 mm

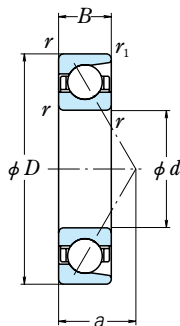

Single

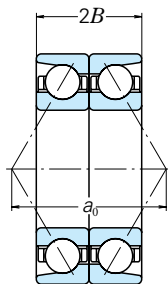

Back-to-Back
DB

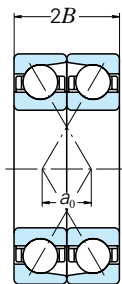

Front-to-Front
DF

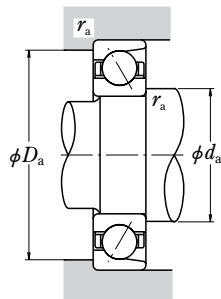

Boundary Dimensions (mm)					Basic Load Ratings (Single) (kN) (kgf)				Eff. Load Centers (mm) a	Abutment and Fillet Dimensions (mm)			Bearing Numbers (1)	
d	D	B	r min.	r_1 min.	C_r	C_{0r}	C_r	C_{0r}		d_a	D_a	r_a max.	Single	Matched
160	200	20	1.1	0.6	54.5	79.5	5 550	8 100	62.0	174	189	1	7832A	DB DF
	200	20	1.1	0.6	48.5	71.0	4 950	7 200	85.5	174	189	1	7832B	DB DF
	220	28	2	1	96.0	121	9 800	12 300	68.8	177	205	2	7932A	DB DF
	220	28	2	1	96.0	121	9 800	12 300	68.8	177	205	2	7932AA	DB DF
	220	28	2	1	85.5	108	8 700	11 000	93.7	177	205	2	7932B	DB DF
	240	38	2.1	1.1	155	176	15 800	18 000	76.7	179	223	2	7032A	DB DF
	240	38	2.1	1.1	139	159	14 100	16 200	102.9	179	223	2	7032B	DB DF
	250	40	2.1	1.1	155	176	15 800	18 000	77.7	179	233	2	BA160-4	DB —
	290	48	3	1.1	263	305	26 800	31 500	89.0	181	270	2.5	7232A	DB DF
	290	48	3	1.1	238	279	24 200	28 400	118.4	181	270	2.5	7232B	DB DF
	340	68	4	1.5	345	420	35 500	43 000	106.2	186	315	3	7332A	DB DF
	340	68	4	1.5	315	385	32 000	39 500	138.9	186	315	3	7332B	DB DF
340	68	4	1.5	315	385	32 000	39 500	138.9	186	315	3	7332BA	DB DF	
170	215	22	1.1	0.6	67.0	96.0	6 850	9 800	66.6	185	203	1	7834A	DB DF
	215	22	1.1	0.6	59.5	85.5	6 050	8 750	91.8	185	203	1	7834B	DB DF
	230	28	2	1	102	135	10 400	13 700	71.7	188	215	2	7934A	DB DF
	230	28	2	1	90.5	121	9 250	12 300	97.9	188	215	2	7934B	DB DF
	260	42	2.1	1.1	186	214	19 000	21 900	83.1	190	243	2	7034A	DB DF
	260	42	2.1	1.1	166	193	17 000	19 700	111.2	190	243	2	7034B	DB DF
	310	52	4	1.5	295	360	30 000	36 500	95.3	196	286	3	7234A	DB DF
	310	52	4	1.5	266	325	27 200	33 000	126.7	196	286	3	7234B	DB DF
	360	72	4	1.5	390	485	39 500	49 500	112.5	196	335	3	7334A	DB DF
	360	72	4	1.5	355	445	36 000	45 500	147.2	196	335	3	7334B	DB DF
	360	72	4	1.5	355	445	36 000	45 500	147.2	196	335	3	7334BA	DB DF

Notes (1) The suffixes A, AA and B, BA represent contact angles of 30° and 40° respectively.

Dynamic Equivalent Load $P = XF_r + YF_a$

Contact Angle	e	Single				DB or DF			
		$F_a/F_r \leq e$		$F_a/F_r > e$		$F_a/F_r \leq e$		$F_a/F_r > e$	
		X	Y	X	Y	X	Y	X	Y
30°	0.80	1	0	0.39	0.76	1	0.78	0.63	1.24
40°	1.14	1	0	0.35	0.57	1	0.55	0.57	0.93

Static Equivalent Load $P_0 = X_0F_r + Y_0F_a$

Contact Angle	Single		DB or DF		Single mounting When $F_r > 0.5F_r + Y_0F_a$ use $P_0 = F_r$
	X_0	Y_0	X_0	Y_0	
30°	0.5	0.33	1	0.66	
40°	0.5	0.26	1	0.52	

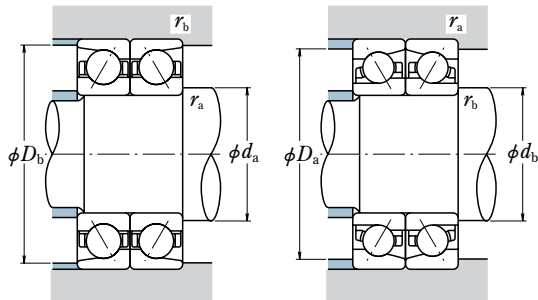

Fig-ure ⁽²⁾	Basic Load Ratings (Matched)				Load Center Spacings (mm)		Abutment and Fillet Dimensions (mm)			Mass (kg)
	(kN)		(kgf)		DB	DF	$d_b^{(3)}$	D_b	$r_b^{(3)}$ max.	
	C_r	C_{0r}	C_r	C_{0r}	a_0					approx.
1	89.0	159	9 050	16 200	123.9	83.9	—	191	0.6	1.39
1	79.0	142	8 050	14 400	171.0	131.0	—	191	0.6	1.38
1	156	241	15 900	24 600	137.7	81.7	—	209	1	3.11
3	156	241	15 900	24 600	137.7	81.7	173	209	1	3.11
1	139	216	14 200	22 000	187.4	131.4	—	209	1	3.11
1	252	355	25 700	36 000	153.5	77.5	—	228	1	5.77
1	225	320	23 000	32 500	205.8	129.8	—	228	1	5.93
1	252	355	25 700	36 000	155.5	—	—	238	1	7.14
1	425	615	43 500	62 500	177.9	81.9	—	277	1	14.1
1	385	555	39 500	57 000	236.8	140.8	—	277	1	14.2
1	565	845	57 500	86 000	212.3	76.3	—	324	1.5	30.7
1	515	770	52 500	78 500	277.8	141.8	—	324	1.5	30.8
3	515	770	52 500	78 500	277.8	141.8	176	324	1.5	29.9
1	109	192	11 100	19 600	133.1	89.1	—	205	0.6	1.85
1	96.5	171	9 850	17 500	183.5	139.5	—	205	0.6	1.83
1	165	269	16 900	27 500	143.5	87.5	—	219	1	3.39
1	147	241	15 000	24 600	195.8	139.8	—	219	1	3.36
1	300	430	31 000	43 500	166.1	82.1	—	247	1	7.9
1	270	385	27 600	39 500	222.4	138.4	—	247	1	7.93
1	480	715	49 000	73 000	190.6	86.6	—	294	1.5	17.3
1	435	650	44 000	66 500	253.4	149.4	—	294	1.5	17.6
1	630	970	64 500	99 000	225.0	81.0	—	343	1.5	35.8
1	575	890	59 000	90 500	294.3	150.3	—	343	1.5	35.6
3	575	890	59 000	90 500	294.3	150.3	187	343	1.5	34.8

Notes ⁽²⁾ Refer to page B 21

⁽³⁾ For bearings marked — in the column for d_b , D_b and r_b for shafts are d_a and $r_a(max.)$ respectively.

ANGULAR CONTACT BALL BEARINGS

SINGLE/MATCHED

Bore Diameter 180 – 190 mm

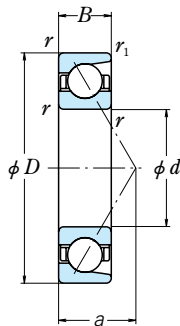

Single

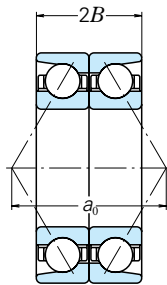

Back-to-Back
DB

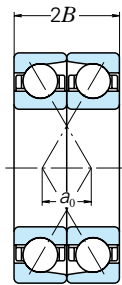

Front-to-Front
DF

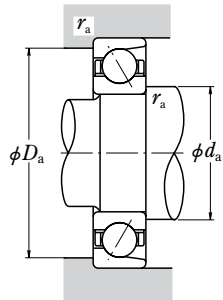

Boundary Dimensions (mm)					Basic Load Ratings (Single)				Eff. Load Centers (mm)	Abutment and Fillet Dimensions (mm)			Bearing Numbers (1)	
<i>d</i>	<i>D</i>	<i>B</i>	<i>r</i> min.	<i>r</i> ₁ min.	<i>C_r</i>	<i>C_{0r}</i>	<i>C_r</i>	<i>C_{0r}</i>		<i>a</i>	<i>d_a</i>	<i>D_a</i>	<i>r_a</i> max.	Single
180	225	22	1.1	0.6	68.5	102	7 000	10 400	69.5	195	213	1	7836A	DB DF
	225	22	1.1	0.6	61.0	91.0	6 200	9 300	96.0	195	213	1	7836B	DB DF
	250	33	2	1	131	167	13 400	17 100	78.6	198	235	2	7936A	DB DF
	250	33	2	1	131	167	13 400	17 100	78.6	198	235	2	7936AA	DB DF
	250	33	2	1	117	150	11 900	15 300	106.7	198	235	2	7936B	DB DF
	250	33	2	1	117	150	11 900	15 300	106.7	198	235	2	7936BA	DB DF
	280	46	2.1	1.1	207	252	21 100	25 700	89.4	200	262	2	7036A	DB DF
	280	46	2.1	1.1	185	227	18 900	23 200	119.5	200	262	2	7036B	DB DF
	320	52	4	1.5	305	385	31 000	39 000	98.2	206	295	3	7236A	DB DF
	320	52	4	1.5	305	385	31 000	39 000	98.2	206	295	3	7236AA	DB DF
	320	52	4	1.5	276	350	28 100	35 500	130.9	206	295	3	7236B	DB DF
	380	75	4	1.5	410	535	41 500	54 500	118.3	206	354	3	7336A	DB DF
380	75	4	1.5	375	490	38 000	50 000	155.0	206	354	3	7336B	DB DF	
380	75	4	1.5	375	490	38 000	50 000	155.0	206	354	3	7336BA	DB DF	
190	240	24	1.5	1	82.0	120	8 350	12 200	74.1	207	226	1.5	7838A	DB DF
	240	24	1.5	1	72.5	107	7 400	10 900	102.2	207	226	1.5	7838B	DB DF
	260	33	2	1	133	175	13 500	17 800	81.5	208	245	2	7938A	DB DF
	260	33	2	1	118	157	12 100	16 000	110.9	208	245	2	7938B	DB DF
	290	46	2.1	1.1	224	280	22 800	28 600	92.3	211	272	2	7038A	DB DF
	290	46	2.1	1.1	201	253	20 400	25 800	123.7	211	272	2	7038B	DB DF
	340	55	4	1.5	315	410	32 000	42 000	104.0	217	315	3	7238A	DB DF
	340	55	4	1.5	284	375	28 900	38 000	138.7	217	315	3	7238B	DB DF
	400	78	5	2	450	600	46 000	61 000	124.2	221	370	4	7338A	DB DF
	400	78	5	2	450	600	46 000	61 000	124.2	221	370	4	7338AA	DB DF
	400	78	5	2	410	550	42 000	56 000	162.8	221	370	4	7338B	DB DF

Notes (1) The suffixes A, AA and B, BA represent contact angles of 30° and 40° respectively.

Dynamic Equivalent Load $P = XF_r + YF_a$

Contact Angle	e	Single				DB or DF			
		$F_a/F_r \leq e$		$F_a/F_r > e$		$F_a/F_r \leq e$		$F_a/F_r > e$	
		X	Y	X	Y	X	Y	X	Y
30°	0.80	1	0	0.39	0.76	1	0.78	0.63	1.24
40°	1.14	1	0	0.35	0.57	1	0.55	0.57	0.93

Static Equivalent Load $P_0 = X_0F_r + Y_0F_a$

Contact Angle	Single		DB or DF		Single mounting When $F_r > 0.5F_r + Y_0F_a$ use $P_0 = F_r$
	X_0	Y_0	X_0	Y_0	
30°	0.5	0.33	1	0.66	
40°	0.5	0.26	1	0.52	

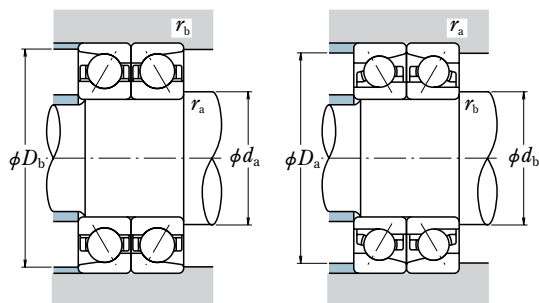

Figure ⁽²⁾	Basic Load Ratings (Matched)				Load Center Spacings (mm)		Abutment and Fillet Dimensions (mm)			Mass (kg)
	(kN)		(kgf)		DB	DF	$d_b^{(3)}$	D_b	$r_b^{(3)}$ max.	
	C_r	C_{0r}	C_r	C_{0r}						
1	111	204	11 400	20 800	138.9	94.9	—	215	0.6	1.93
1	99.0	182	10 100	18 600	191.9	147.9	—	215	0.6	1.92
1	213	335	21 700	34 000	157.1	91.1	—	239	1	4.97
3	213	335	21 700	34 000	157.1	91.1	194	239	1	4.84
1	190	300	19 300	30 500	213.4	147.4	—	239	1	4.84
3	190	300	19 300	30 500	213.4	147.4	194	239	1	4.67
1	335	505	34 500	51 500	178.8	86.8	—	267	1	10.5
1	300	455	30 500	46 500	239.0	147.0	—	267	1	10.8
1	495	770	50 500	78 500	196.3	92.3	—	304	1.5	18.1
3	495	770	50 500	78 500	196.3	92.3	197	304	1.5	17.7
1	450	700	45 500	71 000	261.8	157.8	—	304	1.5	18.4
1	665	1070	68 000	109 000	236.6	86.6	—	363	1.5	42.1
1	605	975	62 000	99 500	309.9	159.9	—	363	1.5	42.6
3	605	975	62 000	99 500	309.9	159.9	197	363	1.5	41.3
1	133	240	13 600	24 400	148.1	100.1	—	229	1	2.47
1	118	214	12 000	21 800	204.4	156.4	—	229	1	2.47
1	216	350	22 000	35 500	162.9	96.9	—	248	1	5.02
1	192	315	19 600	32 000	221.8	155.8	—	248	1	5.07
1	365	560	37 000	57 000	184.6	92.6	—	277	1	11.3
1	325	505	33 000	51 500	247.4	155.4	—	277	1	11.1
1	510	825	52 000	84 000	208.0	98.0	—	324	1.5	22.4
1	460	750	47 000	76 000	277.3	167.3	—	324	1.5	22.4
1	730	1200	74 500	122 000	248.3	92.3	—	382	2	47.5
3	730	1 200	74 500	122 000	248.3	92.3	208	382	2	46.1
1	670	1 100	68 000	112 000	325.5	169.5	—	382	2	47.2

Notes ⁽²⁾ Refer to page B 21

⁽³⁾ For bearings marked — in the column for d_b , D_b and r_b for shafts are d_a and $r_a(max.)$ respectively.

ANGULAR CONTACT BALL BEARINGS

SINGLE/MATCHED

Bore Diameter 200 – 240 mm

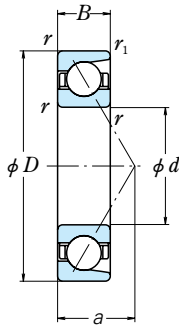

Single

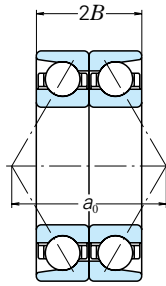

Back-to-Back
DB

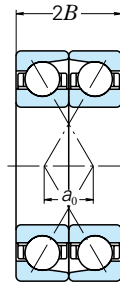

Front-to-Front
DF

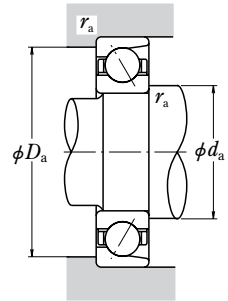

Boundary Dimensions (mm)					Basic Load Ratings (Single) (kN) (kgf)				Eff. Load Centers (mm) a	Abutment and Fillet Dimensions (mm)			Bearing Numbers ⁽¹⁾		
d	D	B	r min.	r_1 min.	C_r	C_{0r}	C_r	C_{0r}		d_a	D_a	r_a max.	Single	Matched	
200	250	24	1.5	1	82.5	124	8 400	12 600	77.0	218	236	1.5	7840A	DB DF	
	250	24	1.5	1	73.0	110	7 450	11 300	106.4	218	236	1.5	7840B	DB DF	
	280	38	2.1	1.1	171	222	17 400	22 600	88.3	221	262	2	7940A	DB DF	
	280	38	2.1	1.1	171	222	17 400	22 600	88.3	221	262	2	7940AA	DB DF	
	280	38	2.1	1.1	152	199	15 500	20 300	119.7	221	262	2	7940B	DB DF	
	280	38	2.1	1.1	152	199	15 500	20 300	119.7	221	262	2	7940BA	DB DF	
	310	51	2.1	1.1	240	310	24 500	31 500	99.1	221	292	2	7040A	DB DF	
	310	51	2.1	1.1	215	280	21 900	28 600	132.5	221	292	2	7040B	DB DF	
	360	58	4	1.5	335	450	34 500	46 000	109.8	227	335	3	7240A	DB DF	
	420	58	4	1.5	305	410	31 000	41 500	146.5	227	335	3	7240B	DB DF	
	420	80	5	2	475	660	48 500	67 000	129.5	231	390	4	7340A	DB DF	
	420	80	5	2	475	660	48 500	67 000	128.8	231	390	4	7340AA	DB DF	
420	80	5	2	430	600	44 000	61 500	170.1	231	390	4	7340B	DB DF		
420	80	5	2	430	600	44 000	61 500	170.1	231	390	4	7340BA	DB DF		
220	270	24	1.5	1	85.0	135	8 650	13 800	82.7	239	255	1.5	7844A	DB DF	
	270	24	1.5	1	75.5	120	7 700	12 300	114.8	239	255	1.5	7844B	DB DF	
	300	38	2.1	1.1	172	233	17 500	23 700	94.1	242	282	2	7944A	DB DF	
	300	38	2.1	1.1	153	208	15 600	21 300	128.1	242	282	2	7944B	DB DF	
	340	56	3	1.1	283	395	28 900	40 000	108.8	244	319	2.5	7044A	DB DF	
	340	56	3	1.1	253	355	25 800	36 000	145.5	244	319	2.5	7044B	DB DF	
	400	65	4	1.5	410	585	41 500	59 500	122.0	248	374	3	7244A	DB DF	
	400	65	4	1.5	370	530	37 500	54 000	162.6	248	374	3	7244B	DB DF	
	460	88	5	2	495	725	50 500	74 000	142.1	252	429	4	7344A	DB DF	
	460	88	5	2	450	665	46 000	67 500	186.6	252	429	4	7344B	DB DF	
	240	300	28	2	1	110	176	11 200	17 900	91.9	260	284	2	7848A	DB DF
		300	28	2	1	97.5	157	9 950	16 000	127.3	260	284	2	7848B	DB DF
320		38	2.1	1.1	181	260	18 400	26 500	99.8	263	301	2	7948A	DB DF	
320		38	2.1	1.1	161	233	16 400	23 700	136.5	263	301	2	7948B	DB DF	
360		56	3	1.1	300	430	30 500	44 000	114.6	265	339	2.5	7048A	DB DF	
360		56	3	1.1	268	390	27 300	39 500	153.9	265	339	2.5	7048B	DB DF	
440		72	4	1.5	435	665	44 500	68 000	134.1	269	413	3	7248A	DB DF	
440		72	4	1.5	390	600	40 000	61 500	178.6	269	413	3	7248B	DB DF	
500		95	5	2	565	880	58 000	89 500	154.3	273	468	4	7348A	DB DF	
500		95	5	2	515	800	52 500	81 500	202.7	273	468	4	7348B	DB DF	

Notes ⁽¹⁾ The suffixes A, AA and B, BA represent contact angles of 30° and 40° respectively.

Dynamic Equivalent Load $P = XF_r + YF_a$

Contact Angle	e	Single				DB or DF			
		$F_a/F_r \leq e$		$F_a/F_r > e$		$F_a/F_r \leq e$		$F_a/F_r > e$	
		X	Y	X	Y	X	Y	X	Y
30°	0.80	1	0	0.39	0.76	1	0.78	0.63	1.24
40°	1.14	1	0	0.35	0.57	1	0.55	0.57	0.93

Static Equivalent Load $P_0 = X_0F_r + Y_0F_a$

Contact Angle	Single		DB or DF		Single mounting When $F_r > 0.5F_r + Y_0F_a$ use $P_0 = F_r$
	X_0	Y_0	X_0	Y_0	
30°	0.5	0.33	1	0.66	
40°	0.5	0.26	1	0.52	

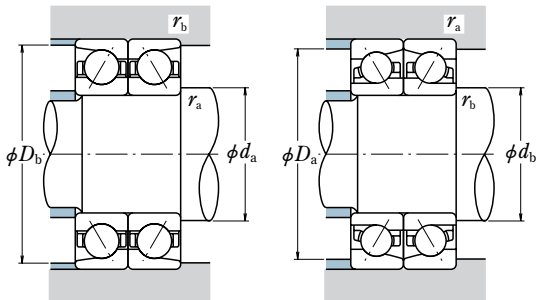

Figure ⁽²⁾	Basic Load Ratings (Matched)				Load Center Spacings (mm)		Abutment and Fillet Dimensions (mm)			Mass (kg)
	(kN)		(kgf)		DB	DF	$d_b^{(3)}$	D_b	$r_b^{(3)}$ max.	
	C_r	C_{0r}	C_r	C_{0r}						
1	134	247	13 600	25 200	153.9	105.9	—	239	1	2.61
1	119	221	12 100	22 500	212.8	164.8	—	239	1	2.59
1	278	445	28 300	45 500	176.6	100.6	—	267	1	7.0
3	278	445	28 300	45 500	176.6	100.6	216	267	1	6.99
1	247	400	25 200	40 500	239.4	163.4	—	267	1	6.99
3	247	400	25 200	40 500	239.4	163.4	216	267	1	6.88
1	390	620	40 000	63 500	198.2	96.2	—	296	1	13.7
1	350	560	35 500	57 000	264.9	162.9	—	296	1	14.1
1	550	900	56 000	92 000	219.6	103.6	—	343	1.5	26.5
1	495	815	50 500	83 000	292.9	176.9	—	343	1.5	26.6
1	770	1 320	78 500	134 000	259.0	99.0	—	401	2	54.4
3	770	1 320	78 500	134 000	257.6	97.6	219	401	2	51.5
1	700	1 200	71 500	123 000	340.1	180.1	—	401	2	55.3
3	700	1 200	71 500	123 000	340.1	180.1	219	401	2	52.4
1	138	270	14 100	27 500	165.5	117.5	—	258	1	2.84
1	122	241	12 500	24 600	229.6	181.6	—	258	1	2.82
1	279	465	28 500	47 500	188.1	112.1	—	287	1	7.6
1	248	415	25 300	42 500	256.2	180.2	—	287	1	7.59
1	460	785	47 000	80 000	217.6	105.6	—	326	1	18.5
1	410	710	42 000	72 500	290.9	178.9	—	326	1	18.4
1	665	1 170	67 500	119 000	244.0	114.0	—	383	1.5	36.5
1	600	1 060	61 000	108 000	325.1	195.1	—	383	1.5	36.1
1	805	1 450	82 000	148 000	284.3	108.3	—	441	2	73.2
1	730	1 330	74 500	135 000	373.3	197.3	—	441	2	72.9
1	179	350	18 200	36 000	183.9	127.9	—	288	1	4.35
1	159	315	16 200	32 000	254.6	198.6	—	288	1	4.35
1	293	520	29 900	53 000	199.7	123.7	—	306	1	8.37
1	261	465	26 600	47 500	272.9	196.9	—	306	1	8.43
1	485	865	49 500	88 000	229.2	117.2	—	345	1	19.3
1	435	780	44 500	79 500	307.7	195.7	—	345	1	19.9
1	705	1 330	72 000	136 000	268.3	124.3	—	422	1.5	50.9
1	635	1 200	64 500	123 000	357.3	213.3	—	422	1.5	50.3
1	920	1 760	94 000	179 000	308.6	118.6	—	480	2	92.5
1	835	1 600	85 500	163 000	405.5	215.5	—	480	2	91.9

Notes ⁽²⁾ Refer to page B 21

⁽³⁾ For bearings marked — in the column for d_b , D_b and r_b for shafts are d_a and $r_a(max.)$ respectively.

ANGULAR CONTACT BALL BEARINGS

SINGLE/MATCHED

Bore Diameter 260 – 320 mm

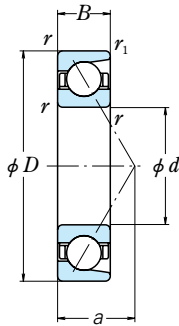

Single

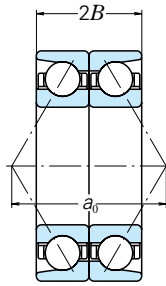

Back-to-Back
DB

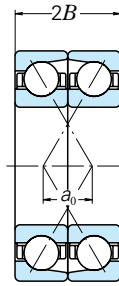

Front-to-Front
DF

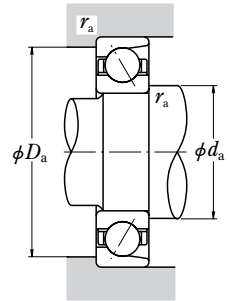

Boundary Dimensions (mm)					Basic Load Ratings (Single)				Eff. Load Centers (mm)	Abutment and Fillet Dimensions (mm)			Bearing Numbers (1)	
d	D	B	r min.	r_1 min.	C_r	C_{0r}	C_r	C_{0r}		a	d_a	D_a	r_a max.	Single
260	320	28	2	1	114	191	11 600	19 400	97.7	281	303	2	7852A	DB DF
	320	28	2	1	101	170	10 300	17 300	135.7	281	303	2	7852B	DB DF
	360	46	2.1	1.1	231	330	23 600	33 500	112.5	283	341	2	7952A	DB DF
	360	46	2.1	1.1	206	297	21 000	30 500	153.1	283	341	2	7952B	DB DF
	400	65	4	1.5	345	525	35 500	53 500	127.8	290	374	3	7052A	DB DF
	400	65	4	1.5	310	475	31 500	48 500	171.0	290	374	3	7052B	DB DF
480	80	5	2	480	750	48 500	76 500	146.8	294	448	4	7252A	DB DF	
	480	80	5	2	430	680	44 000	69 000	195.2	294	448	4	7252B	DB DF
270	320	24	1.5	0.6	85.0	158	8 650	16 100	97.2	291	304	1.5	BA270-1	DB —
	370	46	2.1	1.1	241	360	24 600	36 500	115.4	294	350	2	BA270-2	— DF
280	350	33	2	1	144	232	14 700	23 700	107.4	302	333	2	7856A	DB DF
	350	33	2	1	128	207	13 000	21 100	148.7	302	333	2	7856B	DB DF
	380	46	2.1	1.1	245	375	25 000	38 000	118.3	304	360	2	7956A	DB DF
	380	46	2.1	1.1	218	335	22 300	34 000	161.5	304	360	2	7956B	DB DF
	420	65	4	1.5	345	530	35 000	54 000	133.5	310	393	3	7056A	DB DF
	420	65	4	1.5	325	520	33 000	53 000	179.3	310	393	3	7056B	DB DF
500	80	5	2	510	845	52 000	86 000	152.6	315	468	4	7256A	DB DF	
	500	80	5	2	460	765	47 000	78 000	203.6	315	468	4	7256B	DB DF
300	380	38	2.1	1.1	183	290	18 600	29 600	117.1	325	360	2	7860A	DB DF
	380	38	2.1	1.1	182	285	18 500	29 100	161.6	325	360	2	7860B	DB DF
	420	56	3	1.1	315	500	32 000	51 000	131.9	327	397	2.5	7960A	DB DF
	420	56	3	1.1	279	450	28 400	46 000	179.0	327	397	2.5	7960B	DB DF
	420	56	3	1.1	279	450	28 400	46 000	179.0	327	397	2.5	7960BA	DB DF
	460	74	4	1.5	385	605	39 000	61 500	146.7	331	433	3	7060A	DB DF
320	460	74	4	1.5	345	545	35 000	55 000	196.4	331	433	3	7060B	DB DF
	400	38	2.1	1.1	190	315	19 400	32 500	122.9	346	380	2	7864A	DB DF
	400	38	2.1	1.1	169	283	17 200	28 900	170.0	346	380	2	7864B	DB DF
	440	56	3	1.5	315	525	32 500	53 500	137.7	348	417	2.5	7964A	DB DF
	440	56	3	1.5	282	470	28 800	48 000	187.4	348	417	2.5	7964B	DB DF
	480	74	4	1.5	465	795	47 500	81 000	152.5	352	452	3	7064A	DB DF
580	92	5	2	635	1 120	64 500	114 000	175.9	356	546	4	7264A	DB DF	
	580	92	5	2	590	1 070	60 500	109 000	234.8	356	546	4	7264B	DB DF

Notes (1) The suffixes A, AA and B, BA represent contact angles of 30° and 40° respectively.

Dynamic Equivalent Load $P = XF_r + YF_a$

Contact Angle	e	Single				DB or DF			
		$F_a/F_r \leq e$		$F_a/F_r > e$		$F_a/F_r \leq e$		$F_a/F_r > e$	
		X	Y	X	Y	X	Y	X	Y
30°	0.80	1	0	0.39	0.76	1	0.78	0.63	1.24
40°	1.14	1	0	0.35	0.57	1	0.55	0.57	0.93

Static Equivalent Load $P_0 = X_0F_r + Y_0F_a$

Contact Angle	Single		DB or DF		Single mounting When $F_r > 0.5F_r + Y_0F_a$ use $P_0 = F_r$
	X_0	Y_0	X_0	Y_0	
30°	0.5	0.33	1	0.66	
40°	0.5	0.26	1	0.52	

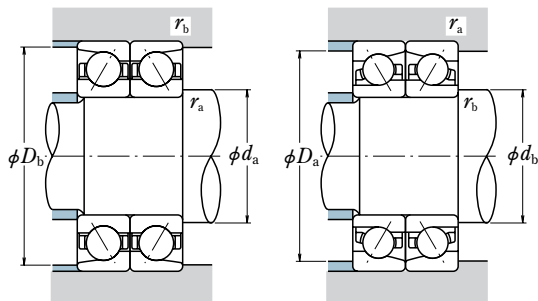

Fig-ure ⁽²⁾	Basic Load Ratings (Matched)				Load Center Spacings (mm)		Abutment and Fillet Dimensions (mm)			Mass (kg)
	(kN)		(kgf)		DB	DF	$d_b^{(3)}$	D_b	$r_b^{(3)}$ max.	
	C_r	C_{0r}	C_r	C_{0r}						
1	185	380	18 800	39 000	195.4	139.4	—	307	1	4.69
1	164	340	16 700	34 500	271.3	215.3	—	307	1	4.67
1	375	660	38500	67 500	225.0	133.0	—	345	1	14.3
1	335	595	34 000	60 500	306.1	214.1	—	345	1	14.2
1	565	1 050	57 500	107 000	255.5	125.2	—	383	1.5	28.7
1	505	945	51 500	96 500	341.9	211.9	—	383	1.5	29
1	775	1 500	79 000	153 000	293.6	133.6	—	460	2	65.3
1	700	1 360	71 000	138 000	390.5	230.5	—	460	2	65.5
1	138	315	14 100	32 000	194.3	—	—	308	0.6	3.45
2	390	715	40000	73 000	—	138.8	—	—	—	14.7
1	234	465	23 900	47 500	214.9	148.9	—	337	1	7.08
1	208	415	21 200	42 500	297.3	231.3	—	337	1	7.03
1	400	745	40 500	76 000	236.5	144.6	—	365	1	15
1	355	670	36 000	68 000	322.9	230.9	—	365	1	15
1	560	1 060	57 000	108 000	267.1	137.1	—	402	1.5	31.2
1	530	1 040	54 000	106 000	358.7	228.7	—	402	1.5	31
1	830	1 690	84 500	172 000	305.2	145.2	—	480	2	69
1	745	1 530	76 000	156 000	407.2	247.2	—	480	2	70.1
1	297	580	30 500	59 000	234.3	158.3	—	365	1	10.1
1	295	570	30 000	58 000	323.3	247.3	—	365	1	9.91
1	510	1 000	52 000	102 000	263.8	151.8	—	404	1	24.4
1	455	900	46 000	92 000	358.1	246.1	—	404	1	23.7
3	455	900	46 000	92 000	358.1	246.1	320	404	1	23.6
1	625	1 210	64 000	123 000	293.4	145.4	—	441	1.5	44.9
1	560	1 090	57 000	111 000	392.9	244.9	—	441	1.5	44.5
1	310	635	31 500	64 500	245.8	169.8	—	385	1	10.5
1	274	565	28 000	58 000	340.1	264.1	—	385	1	10.5
1	515	1 050	52 500	107 000	275.4	163.4	—	422	1.5	25.9
1	460	940	46 500	96 000	374.9	262.9	—	424	1	25.3
1	755	1 590	77 000	162 000	304.9	156.9	—	461	1.5	47.2
1	675	1 430	69 000	146 000	409.6	261.6	—	461	1.5	46.9
1	1030	2 230	105 000	228 000	351.8	167.8	—	558	2	110
1	960	2 140	98 000	219 000	469.6	285.6	—	558	2	109

Notes ⁽²⁾ Refer to page B 21

⁽³⁾ For bearings marked — in the column for d_b , D_b and r_b for shafts are d_a and r_a (max.) respectively.

ANGULAR CONTACT BALL BEARINGS

SINGLE/MATCHED

Bore Diameter 340 – 470 mm

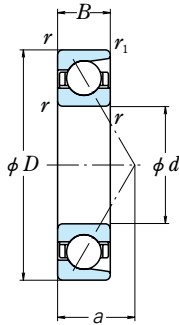

Single

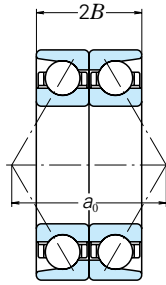

Back-to-Back
DB

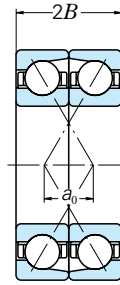

Front-to-Front
DF

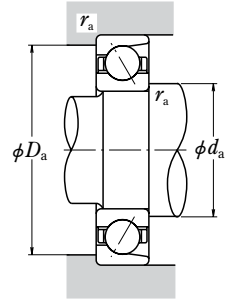

	Boundary Dimensions (mm)					Basic Load Ratings (Single) (kN) (kgf)				Eff. Load Centers (mm) a	Abutment and Fillet Dimensions (mm)			Bearing Numbers (1)	
	d	D	B	r min.	r_1 min.	C_r	C_{0r}	C_r	C_{0r}		d_a	D_a	r_a max.	Single	Matched
340	420	38	2.1	1.1	191	325	19 500	33 500	128.7	367	399	2	7868A	DB DF	
	420	38	2.1	1.1	169	292	17 300	29 800	178.4	367	399	2	7868B	DB DF	
	460	56	3	1.1	330	565	33 500	58 000	143.5	369	437	2.5	7968A	DB DF	
	460	56	3	1.1	292	510	29 800	52 000	195.8	369	437	2.5	7968B	DB DF	
	520	82	5	2	520	905	53 000	92 500	165.1	377	488	4	7068A	DB DF	
	520	82	5	2	465	820	47 500	83 500	221.4	377	488	4	7068B	DB DF	
360	440	38	2.1	1.1	219	380	22 300	39 000	134.5	387	419	2	7872A	DB DF	
	440	38	2.1	1.1	194	340	19 800	35 000	186.8	387	419	2	7872B	DB DF	
	480	56	3	1.1	330	590	34 000	60 000	149.2	389	456	2.5	7972A	DB DF	
	480	56	3	1.1	295	530	30 000	54 000	204.2	389	456	2.5	7972B	DB DF	
	540	82	5	2	530	960	54 500	98 000	171.0	398	507	4	7072A	DB DF	
	540	82	5	2	475	865	48 500	88 000	229.9	398	507	4	7072B	DB DF	
380	650	95	6	3	670	1 280	68 500	130 000	193.3	404	609	5	7272A	DB DF	
	650	95	6	3	600	1 150	61 500	118 000	259.4	404	609	5	7272B	DB DF	
	520	65	4	1.5	390	725	40 000	74 000	162.4	414	491	3	7976A	DB DF	
	520	65	4	1.5	345	650	35 500	66 000	221.3	414	491	3	7976B	DB DF	
381	560	82	5	2	495	875	50 500	89 000	176.7	419	527	4	7076A	DB DF	
	560	82	5	2	440	790	45 000	80 500	238.2	419	527	4	7076B	DB DF	
381	540	82	5	2	420	750	43 000	76 500	173.8	420	507	4	BA381-1	DB —	
400	540	65	4	1.5	395	750	40 500	76 500	168.2	435	511	3	7980A	DB DF	
	540	65	4	1.5	350	675	36 000	68 500	229.7	435	511	3	7980B	DB DF	
	600	90	5	2	555	1 010	57 000	103 000	189.3	439	566	4	7080A	DB DF	
	600	90	5	2	500	915	51 000	93 500	254.8	439	566	4	7080B	DB DF	
420	560	53	3	1.5	370	735	38 000	75 000	168.0	452	535	2.5	BA420-1	DB —	
	560	65	4	1.5	410	805	41 500	82 000	174.0	456	531	3	7984A	DB DF	
	560	65	4	1.5	365	720	37 000	73 500	238.1	456	531	3	7984B	DB DF	
	620	90	5	2	610	1 190	62 500	122 000	195.1	460	586	4	7084A	DB DF	
	620	90	5	2	550	1 070	56 000	110 000	263.2	460	586	4	7084B	DB DF	
	760	109	7.5	4	775	1 620	79 000	165 000	224.8	475	709	6	7284A	DB DF	
460	760	109	7.5	4	695	1 460	70 500	149 000	302.0	475	709	6	7284B	DB DF	
	540	40	2.1	1.1	198	430	20 200	44 000	164.3	491	517	2	BA460-1	DB —	
470	570	50	2.1	1.1	310	645	31 500	65 500	175.1	502	546	2	BA470-1	DB —	

Notes (1) The suffixes A, AA and B, BA represent contact angles of 30° and 40° respectively.

Dynamic Equivalent Load $P = XF_r + YF_a$

Contact Angle	e	Single				DB or DF			
		$F_a/F_r \leq e$		$F_a/F_r > e$		$F_a/F_r \leq e$		$F_a/F_r > e$	
		X	Y	X	Y	X	Y	X	Y
30°	0.80	1	0	0.39	0.76	1	0.78	0.63	1.24
40°	1.14	1	0	0.35	0.57	1	0.55	0.57	0.93

Static Equivalent Load $P_0 = X_0F_r + Y_0F_a$

Contact Angle	Single		DB or DF		Single mounting When $F_r > 0.5F_r + Y_0F_a$ use $P_0 = F_r$
	X_0	Y_0	X_0	Y_0	
30°	0.5	0.33	1	0.66	
40°	0.5	0.26	1	0.52	

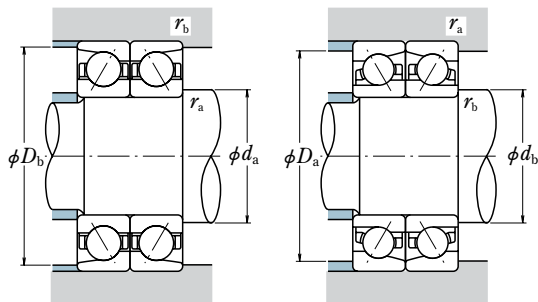

Fig- ure ⁽²⁾	Basic Load Ratings (Matched)				Load Center Spacings (mm)		Abutment and Fillet Dimensions (mm)			Mass (kg)
	(kN)		(kgf)		DB	DF	$d_b^{(3)}$	D_b	$r_b^{(3)}$ max.	
	C_r	C_{0r}	C_r	C_{0r}						
1	310	655	31 500	67 000	257.4	181.4	—	404	1	11.1
1	275	585	28 000	59 500	356.9	280.9	—	404	1	11.2
1	535	1 130	54 500	116 000	286.9	174.9	—	443	1	27.2
1	475	1 020	48 500	104 000	391.6	279.6	—	443	1	27.2
1	845	1 810	86 000	185 000	330.3	166.3	—	499	2	60.5
1	755	1 640	77 000	167 000	442.8	278.8	—	499	2	61.8
1	355	765	36 500	78 000	268.9	192.9	—	424	1	11.7
1	315	680	32 000	69 500	373.6	297.6	—	424	1	11.7
1	540	1 180	55 000	120 000	298.5	186.5	—	463	1	27.9
1	480	1 060	49 000	108 000	408.4	296.4	—	463	1	27.9
1	865	1 920	88 000	196 000	342.0	178.0	—	519	2	62.4
1	775	1 730	79 000	176 000	459.8	295.8	—	519	2	63.6
1	1 090	2 550	111 000	260 000	386.6	196.6	—	623	2.5	144
1	975	2 310	99 500	235 000	518.7	328.7	—	623	2.5	140
1	635	1 450	64 500	148 000	324.8	194.8	—	500	1.5	39.8
1	565	1 300	57 500	132 000	442.6	312.6	—	500	1.5	40.7
1	800	1 750	82 000	178 000	353.4	189.4	—	539	2	67.9
1	720	1 580	73 000	161 000	476.4	312.4	—	539	2	66.7
1	680	1 500	69 500	153 000	347.6	—	—	519	2	114
1	640	1 500	65 500	153 000	336.4	206.4	—	520	1.5	42.1
1	570	1 350	58 000	137 000	459.4	329.4	—	520	1.5	42.3
1	905	2 030	92 000	207 000	378.7	198.7	—	578	2	85.9
1	810	1 830	82 500	187 000	509.5	329.5	—	578	2	86.2
2	605	1 470	61 500	150 000	335.9	—	—	539	1.5	36.2
1	665	1 610	67 500	164 000	347.9	217.9	—	539	1.5	44
1	590	1 440	60 000	147 000	476.2	346.2	—	539	1.5	44.4
1	995	2 380	101 000	243 000	390.2	210.2	—	597	2	90.3
1	890	2 150	91 000	219 000	526.3	346.3	—	597	2	90.6
1	1 260	3 250	128 000	330 000	449.6	231.6	—	727	3	228
1	1 130	2 920	115 000	298 000	604.1	386.1	—	727	3	220
1	320	860	33 000	87 500	328.7	—	—	522	1	15.8
1	505	1 290	51 500	131 000	350.2	—	—	551	1	25.3

Notes ⁽²⁾ Refer to page B 21

⁽³⁾ For bearings marked — in the column for d_b , D_b and r_b for shafts are d_a and $r_a(max.)$ respectively.

ANGULAR CONTACT BALL BEARINGS

SINGLE/MATCHED

Bore Diameter 500 – 775 mm

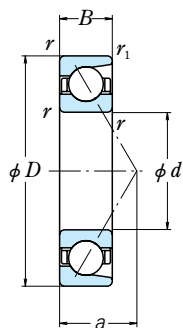

Single

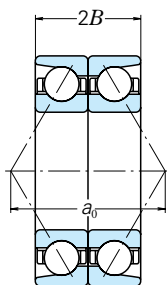

Back-to-Back
DB

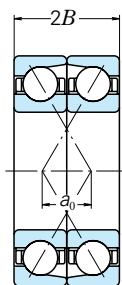

Front-to-Front
DF

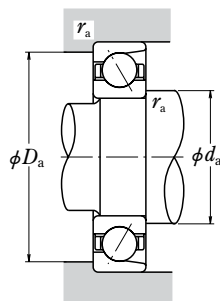

Boundary Dimensions (mm)				Basic Load Ratings (Single) (kN) (kgf)				Eff. Load Centers (mm) a	Abutment and Fillet Dimensions (mm)			Bearing Numbers ⁽¹⁾		
d	D	B	r min.	r_1 min.	C_r	C_{0r}	C_r		C_{0r}	d_a	D_a	r_a max.	Single	Matched
500	620	42	2.1	1.1	232	490	23 600	50 000	182.7	533	595	2	BA500-1	DB —
	620	52	2.1	1.1	310	665	31 500	67 500	187.7	533	595	2	BA500-3	DB —
540	660	56	3	1.1	390	895	39 500	91 000	201.2	577	633	2.5	BA540-2	DB —
760	860	50	4	1.5	256	735	26 100	75 000	258.8	810	825	3	BA760-1	DB —
775	1 080	90	6	3	590	1 700	60 500	174 000	312.7	836	1030	5	BA775-1	DB —

Note ⁽¹⁾ The suffixes A, AA and B, BA represent contact angles of 30° and 40° respectively.

Dynamic Equivalent Load $P = XF_r + YF_a$

Contact Angle	e	Single				DB or DF			
		$F_a/F_r \leq e$		$F_a/F_r > e$		$F_a/F_r \leq e$		$F_a/F_r > e$	
		X	Y	X	Y	X	Y	X	Y
30°	0.80	1	0	0.39	0.76	1	0.78	0.63	1.24
40°	1.14	1	0	0.35	0.57	1	0.55	0.57	0.93

Static Equivalent Load $P_0 = X_0F_r + Y_0F_a$

Contact Angle	Single		DB or DF		Single mounting When $F_r > 0.5F_r + Y_0F_a$ use $P_0 = F_r$
	X_0	Y_0	X_0	Y_0	
30°	0.5	0.33	1	0.66	
40°	0.5	0.26	1	0.52	

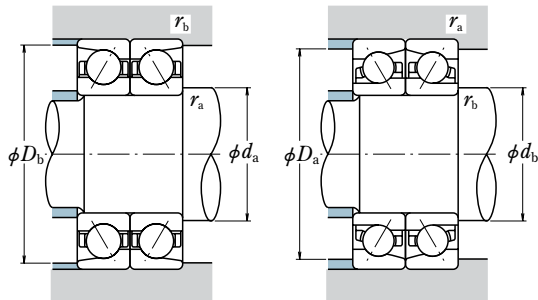

Fig-ure ⁽²⁾	Basic Load Ratings (Matched)				Load Center Spacings (mm)		Abutment and Fillet Dimensions (mm)				Mass (kg)
	(kN)		(kgf)		DB	DF	$d_b^{(3)}$	D_b	$r_b^{(3)}$ max.	approx.	
	C_r	C_{0r}	C_r	C_{0r}							
1	375	980	38 500	100 000	365.3	—	—	600	1	29.2	
1	505	1 330	51 500	135 000	375.3	—	—	600	1	35.1	
1	635	1 790	64 500	182 000	402.4	—	—	639	1	78.2	
1	415	1 470	42 500	150 000	517.7	—	—	833	1.5	40.1	
1	960	3 400	98 000	345 000	625.5	—	—	1044	2.5	274	

Notes ⁽²⁾ Refer to page B 21

⁽³⁾ For bearings marked — in the column for d_b , D_b and r_b , for shafts are d_a and r_a (max.) respectively.

DOUBLE-ROW ANGULAR CONTACT BALL BEARINGS

Bore Diameter 100 – 280 mm

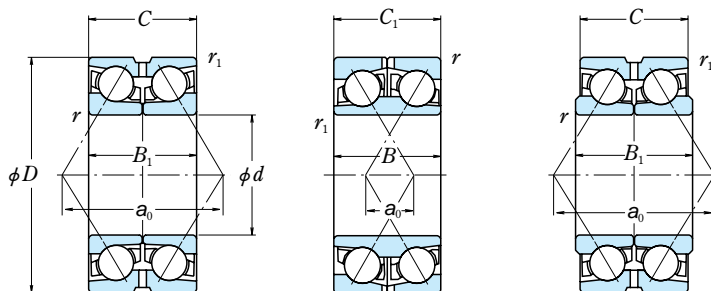

<i>d</i>	Boundary Dimensions (mm)					Basic Load Ratings			
	<i>D</i>	<i>B, B₁</i>	<i>C, C₁</i>	<i>r</i> min.	<i>r₁</i> min.	<i>C_r</i> (kN)	<i>C_{0r}</i> (kgf)	<i>C_r</i> (kgf)	<i>C_{0r}</i> (kgf)
100	170	60.3	60.3	2	2	136	162	13 900	16 500
120	180	56	56	2	1	148	192	15 100	19 600
	190	66	66	2	2	187	236	19 000	24 100
140	209.5	66	66	2	2	174	239	17 700	24 400
	210	66	66	2	2	174	239	17 700	24 400
150	225	73	73	2.1	2.1	199	277	20 300	28 200
	230	70	70	2.1	2.1	221	300	22 500	30 500
	240	84	84	1.5	1	258	345	26 300	35 000
160	215	56	50	1.1	1.1	128	213	13 100	21 800
	239.5	76	76	2	2	225	320	23 000	32 500
	240	76	76	2	2	225	320	23 000	32 500
170	259.5	84	84	2.1	2.1	270	385	27 600	39 500
	260	84	84	2.1	2.1	270	385	27 600	39 500
175	280	92	92	2.1	2.1	293	435	29 900	44 000
180	250	66	66	2	2	190	300	19 300	30 500
	250	70	70	2	2	190	300	19 300	30 500
	259.5	66	66	2	2	262	390	26 700	40 000
	280	92	92	2.1	1.1	300	455	30 500	46 500
190	255	66	58	1.1	1.1	179	305	18 200	31 500
	269.5	66	66	2	2	267	405	27 200	41 500
	280	96	90	2.1	1.1	282	430	28 700	43 500
	290	92	92	2.1	1.1	325	505	33 000	51 500
200	279.5	76	76	2.1	1.1	247	400	25 200	40 500
	280	76	76	2	1.1	247	400	25 200	40 500
	280	80	80	2.1	1.1	247	400	25 200	40 500
	289.5	76	76	2.1	2.1	299	465	30 500	47 500
	309.5	96	96	2.1	2.1	355	560	36 000	57 000
	310	96	96	2.1	2.1	355	560	36 000	57 000
220	300	76	70	1	1.5	231	405	23 500	41 500
	309.5	76	76	2	2	335	545	34 000	56 000
230	329.5	80	80	2.1	2.1	360	615	37 000	62 500
250	340	76	70	1.5	1.5	274	515	27 900	52 500
260	369.5	92	92	2.1	2.1	415	770	42 000	78 500
	400	130	130	4	1.5	505	945	51 500	96 500
280	389.5	92	92	2.1	2.1	380	740	38 500	75 500

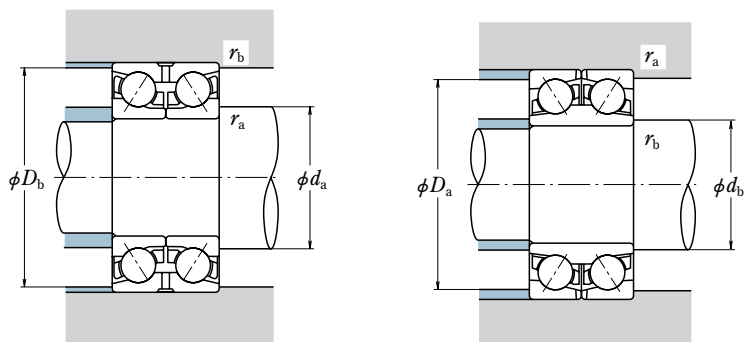

Bearing Numbers ⁽¹⁾	Figure ⁽²⁾	Load Center Spacings (mm) a_0	Abutment and Fillet Dimensions (mm)				Mass (kg) approx.
			d_a, d_b ⁽³⁾	D_a, D_b ⁽⁴⁾	r_a max.	r_b max.	
100BDZ1701E4	5	144.3	115	156	2	2	5.64
120BDZ10E4	5	153.9	136	170	2	1	4.99
*120BDZ1901E4	5	122.5	136	176	2	2	7.09
140BDZ10XE4	5	179.8	156	195	2	2	7.93
140BDZ10E4	5	179.8	156	196	2	2	8.0
150BDZ2201E4	5	193.8	169	208	2	2	10.2
150BDZ2301E4	5	194.4	169	213	2	2	10.5
150BDY2401E	6	121.6	166	229	1.5	1	14.6
160BDZ2101E4	7	182.3	174	203	1	1	5.41
160BDZ10XE4	5	205.8	177	224	2	2	11.9
160BDY10E	6	129.8	177	225	2	2	12
170BDZ10XE4	5	222.4	190	242	2	2	16
170BDY10E	6	138.4	190	243	2	2	16.1
175BDY2801E	6	144.9	195	262	2	2	21.7
180BDY09E	6	147.4	198	235	2	2	9.83
180BDY2501E	6	145.4	198	235	2	2	10.4
*180BDZ2501E4	5	160.0	198	244	2	2	11.4
180BDY10E	6	147.0	200	267	2	1	20.9
190BDZ2501E4	7	215.2	205	243	1	1	8.69
*190BDZ2601E4	5	165.8	208	254	2	2	11.9
190BDZ2801E4	7	242.2	211	267	2	1	19.5
190BDY10E	6	155.4	211	277	2	1	21.9
200BDZ09XE4	5	239.4	221	267	2	1	14.3
200BDY09E	6	163.4	219	267	2	1	14.4
200BDY2801E	6	161.4	221	267	2	1	15.2
*200BDZ2801E4	5	179.5	221	271	2	2	16.5
200BDZ3001E4	5	262.0	221	291	2	2	26.5
200BDY3101E	6	166.0	221	292	2	2	26.6
220BDZ09E4	7	252.5	236	285	1	1.5	14.6
*220BDZ3001E4	5	191.0	240	293	2	2	17.8
*230BDZ3201E4	5	201.7	252	311	2	2	22
250BDZ3401E4	7	282.5	270	324	1.5	1.5	19.2
*260BDZ3601E4	5	227.6	283	350	2	2	31.4
260BDY10E	6	211.9	290	383	3	1.5	59.4
280BDZ3801E4	5	327.1	304	369	2	2	33.4

Note ⁽¹⁾ * Bearings marked * represent contact angle 30°, and other bearings are 40°.

⁽²⁾ Refer to page **B 22**.

⁽³⁾ d_a for Figures 5 and 7. d_b for Figure 6.

⁽⁴⁾ D_b for Figures 5 and 7. D_a for Figure 6.

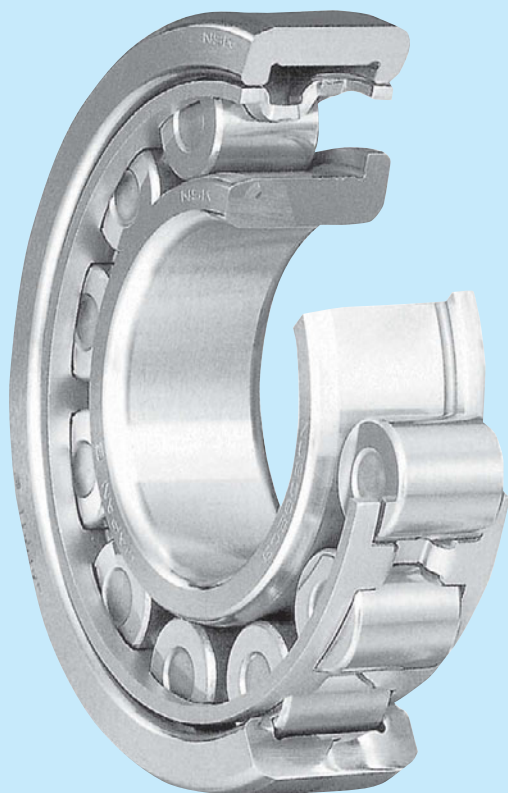

CYLINDRICAL ROLLER BEARINGS

Single-Row Cylindrical Roller Bearings	Bore Diameter 100 – 1 320mm	B48
Double-Row Cylindrical Roller Bearings	Bore Diameter 100 – 850mm	B66

Design, Types, and Features

Depending on the existence of ribs on their rings, cylindrical roller bearings are classified into the following types.

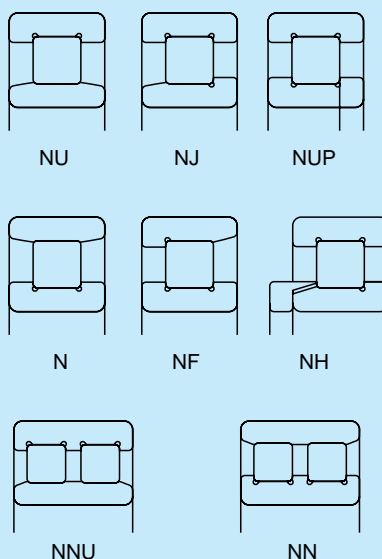

Types NU, N, NNU, and NN are suitable as free-end bearings. Types NJ and NF can sustain limited axial loads in one direction. Types NH and NUP can be used as fixed-end bearings. Loose rib for NUP inner ring should be mounted so that its marked side faces outward.

If high load capacity is required, Series E cylindrical roller bearings, which have larger rollers and more rollers than usual, are also available.

For standard cylindrical roller bearings, either pressed, machined or pintype cages are used.

Regarding four-row cylindrical roller bearings, refer to page B388.

Tolerances and Running Accuracy.....Table 2.2 (Pages A16 to A19)

**Single-Row
Cylindrical Roller Bearings**

**Double-Row
Cylindrical Roller Bearings**

Table 1 Tolerances for Roller Inscribed Circle Diameter F_w and Roller Circumscribed Circle Diameter E_w of Cylindrical Roller Bearings Having Interchangeable Rings

Units : μm

Nominal Bore Diameter d (mm)		Tolerances for F_w of types NU, NJ, NUP, NH, and NNU ΔF_w		Tolerances for E_w of types N, NF, and NN ΔE_w	
over	incl	high	low	high	low
50	120	+20	0	0	-20
120	200	+25	0	0	-25
200	250	+30	0	0	-30
250	315	+35	0	0	-35
315	400	+40	0	0	-40
400	500	+45	0	0	-45
500	630	+45	0	0	-45
630	800	+50	0	0	-50
800	1 000	+60	0	0	-60
1 000	1 250	+70	0	0	-70
1 250	1 600	+80	0	0	-80

Remarks The deviation surrounded with a frame in table is **NSK** specification.

Recommended FitsTable 3.2 (Page A35)
Table 3.4 (Page A36)

**Single-Row
Cylindrical Roller Bearings**

**Double-Row
Cylindrical Roller Bearings**

Internal ClearancesTable 3.11 (Page A41)

**Single-Row
Cylindrical Roller Bearings**

**Double-Row
Cylindrical Roller Bearings**

Permissible Misalignment

The permissible misalignment of cylindrical roller bearings varies depending on the type and internal specifications, but under normal loads, the angles are approximately as follows:

- Width series 0 or 1 0.0012 radian (4')
- Width series 2 0.0006 radian (2')

For double-row cylindrical roller bearings, nearly no misalignment is allowed.

Precautions for Use of Cylindrical Roller Bearings

If the load on cylindrical roller bearings becomes too small during operation, slippage between the rollers and raceways occurs, which may result in smearing. Especially with large bearings since the weight of the rollers and cage is high.

If very small bearing loads are expected, please consult with **NSK** for selection of the bearings.

SINGLE-ROW CYLINDRICAL ROLLER BEARINGS

Bore Diameter 100 – 110 mm

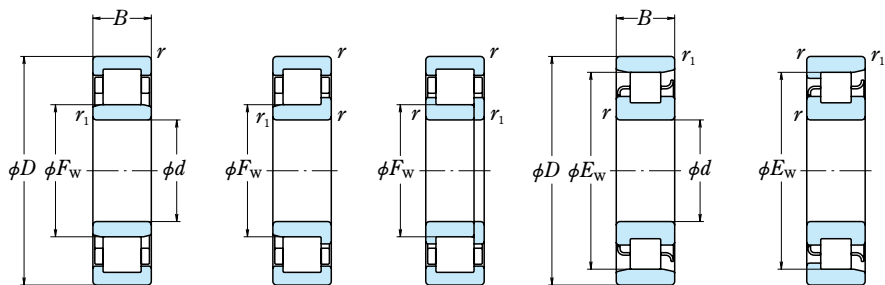

NU

NJ

NUP

N

NF

<i>d</i>	Boundary Dimensions (mm)						Basic Load Ratings (kN)	
	<i>D</i>	<i>B</i>	<i>r</i> min.	<i>r</i> ₁ min.	<i>F</i> _W	<i>E</i> _W	<i>C</i> _r	<i>C</i> _{0r}
100	125	19	1	0.6	106.5	118.5	58.5	111
	150	24	1.5	1.1	113	137	93	126
	180	34	2.1	2.1	—	160	183	217
	180	34	2.1	2.1	119	—	249	305
	180	46	2.1	2.1	119	—	335	445
	180	60.3	2.1	2.1	120	—	325	460
	215	47	3	3	—	185.5	299	335
	215	47	3	3	129.5	—	299	335
	215	47	3	3	127.5	—	380	425
	215	73	3	3	127.5	—	570	715
215	82.6	3	3	129.5	—	560	760	
250	58	4	4	139	211	450	500	
105	160	26	2	1.1	119.5	145.5	109	149
	190	36	2.1	2.1	—	168.8	201	241
	190	36	2.1	2.1	125	—	262	310
	190	65.1	2.1	2.1	126.8	—	360	505
	225	49	3	3	—	195	320	360
	225	49	3	3	133	—	425	480
	260	60	4	4	144.5	220.5	495	555
	260	60	4	4	144.5	220.5	495	555
110	150	20	1.1	1	120	140	70.5	102
	170	28	2	1.1	125	155	131	174
	200	38	2.1	2.1	—	178.5	229	272
	200	38	2.1	2.1	132.5	—	293	365
	200	53	2.1	2.1	132.5	—	385	515
	200	69.8	2.1	2.1	132.5	178.5	425	605
	240	50	3	3	—	207	360	400
	240	50	3	3	143	—	450	525
	240	80	3	3	143	—	675	880
	240	80	3	3	143	—	675	880
	240	92.1	3	3	143	207	675	910
	280	65	4	4	155	—	550	620

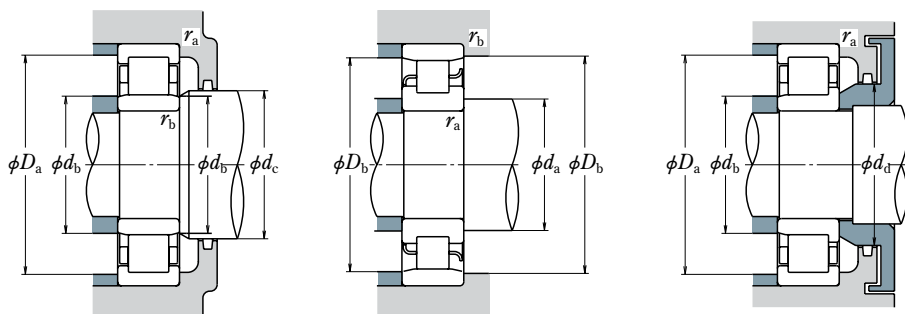

Bearing Numbers	Abutment and Fillet Dimensions (mm)							Mass (kg)	
	d_a	$d_b^{(1)}$	d_c min.	d_d min.	D_a	D_b	r_a max.	r_b max.	approx.
NU3820	108	105	—	—	117	119	1	0.6	0.54
NU1020	108	111	116	—	142	139	1.5	1	1.47
N 220	111	—	—	—	—	163	2	2	3.36
NU 220 EM	111	116	122	130	169	—	2	2	3.81
NU2220 EM	111	116	122	130	169	—	2	2	4.69
NU3220	—	114	—	—	165	—	2	2	6.83
N 320	113	—	—	—	—	190	2.5	2.5	7.59
NU 320	113	126	132	143	202	—	2.5	2.5	7.69
NU 320 EM	113	124	132	143	202	—	2.5	2.5	8.63
NU2320 EM	113	124	132	143	202	—	2.5	2.5	11.8
NU3320	—	116	—	—	197	—	2.5	2.5	15.5
NU 420	116	135	141	156	234	215	3	3	15.5
NU1021	114	118	122	—	151	147	2	1	1.83
N 221	116	—	—	—	—	172	2	2	4.0
NU 221 EM	116	121	129	137	179	—	2	2	4.58
NU3221	—	119	—	—	175	—	2	2	8.32
N 321	118	—	—	—	—	199	2.5	2.5	8.69
NU 321 EM	118	131	137	149	212	—	2.5	2.5	9.84
NU 421	121	141	147	162	244	225	3	3	17.3
NU1922	119	118	—	—	140	142	1	1	1.03
NU1022	119	123	128	—	161	157	2	1	2.27
N 222	121	—	—	—	—	182	2	2	4.64
NU 222 EM	121	129	135	144	189	—	2	2	5.37
NU2222 EM	121	129	135	144	189	—	2	2	7.65
NU3222	124	124	—	—	185	185	2	2	9.85
N 322	123	—	—	—	—	211	2.5	2.5	10.3
NU 322 EM	123	139	145	158	227	—	2.5	2.5	11.8
NU2322 EM	123	139	145	158	227	—	2.5	2.5	18.9
NU3322	126	126	—	—	222	222	2.5	2.5	21.5
NU 422	126	151	157	173	264	—	3	3	22.1

Notes ⁽¹⁾ d_b are values for adjusting ring for NU, NJ types.

SINGLE-ROW CYLINDRICAL ROLLER BEARINGS

Bore Diameter 120 – 130 mm

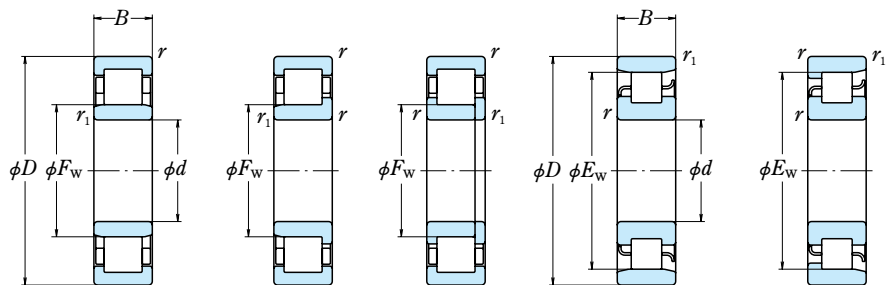

NU

NJ

NUP

N

NF

<i>d</i>	Boundary Dimensions (mm)						Basic Load Ratings (kN)	
	<i>D</i>	<i>B</i>	<i>r</i> min.	<i>r</i> ₁ min.	<i>F</i> _W	<i>E</i> _W	<i>C</i> _r	<i>C</i> _{0r}
120	165	22	1.1	1	131.5	153.5	98.0	150
	165	27	1.1	1.1	131.5	153.5	111	175
	180	28	2	1.1	135	165	139	191
	215	40	2.1	2.1	—	191.5	248	299
	215	40	2.1	2.1	143.5	—	335	420
	215	58	2.1	2.1	143.5	—	450	620
	215	76	2.1	2.1	143.5	191.5	460	665
	260	55	3	3	—	226	450	510
	260	55	3	3	154	—	530	610
	260	86	3	3	154	—	795	1 030
	260	106	3	3	154	—	845	1 150
	310	72	5	5	170	260	675	770
130	165	26	1.1	1	139.5	155.5	103	205
	180	30	1.5	1.1	143	167	145	240
	200	33	2	1.1	148	182	172	238
	230	40	3	3	—	204	258	320
	230	40	3	3	153.5	—	365	455
	230	64	3	3	153.5	—	530	735
	230	80	3	3	156	—	480	715
	280	58	4	4	—	243	500	570
	280	58	4	4	167	—	615	735
	280	93	4	4	167	—	920	1 230
	280	112	4	4	167	243	935	1 290
	340	78	5	5	185	285	825	955

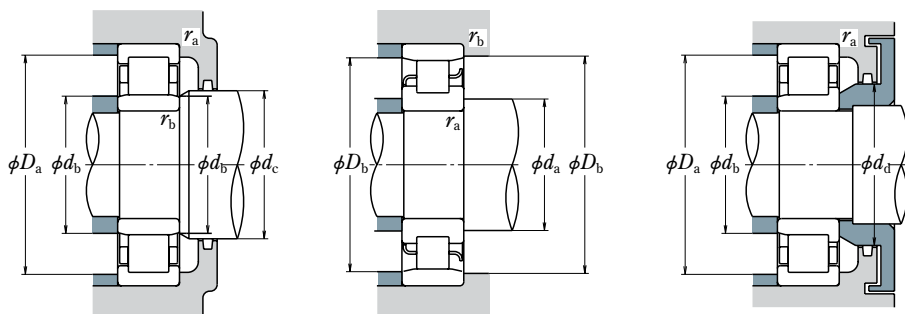

Bearing Numbers	Abutment and Fillet Dimensions (mm)								Mass (kg) approx.
	d_a	d_b ⁽¹⁾	d_c min.	d_d min.	D_a	D_b	r_a max.	r_b max.	
NU1924	130	128	—	—	155	156	1	1	1.42
NU2924	130	130	—	—	155	155	1	1	1.69
NU1024	129	133	138	—	171	167	2	1	2.43
N 224	131	—	—	—	—	196	2	2	5.63
NU 224 EM	131	140	146	156	204	—	2	2	6.43
NU2224 EM	131	140	146	156	204	—	2	2	9.51
NU3224	134	134	—	—	199	199	2	2	12.2
N 324	133	—	—	—	—	230	2.5	2.5	12.9
NU 324 EM	133	150	156	171	247	—	2.5	2.5	15
NU2324 EM	133	150	156	171	247	—	2.5	2.5	25
NU3324	—	136	—	—	242	—	2.5	2.5	29
NU 424	140	166	172	190	290	266	4	4	30.2
NU3826	140	138	—	—	155	156	1	1	1.36
NU2926	141	140	—	—	168	170	1.5	1	2.32
NU1026	139	146	151	—	191	184	2	1	3.66
N 226	143	—	—	—	—	208	2.5	2.5	6.48
NU 226 EM	143	150	158	168	217	—	2.5	2.5	8.03
NU2226 EM	143	150	158	168	217	—	2.5	2.5	9.44
NU3226	—	146	—	—	212	—	2.5	2.5	14.4
N 326	146	—	—	—	—	247.5	3	3	17.7
NU 326 EM	146	163	169	184	264	—	3	3	18.7
NU2326 EM	146	163	169	184	264	—	3	3	30
NU3326	149	149	—	—	258	258	3	3	35.2
NU 426	150	180	187	208	320	291	4	4	39.6

Notes ⁽¹⁾ d_b are values for adjusting ring for NU, NJ types.

SINGLE-ROW CYLINDRICAL ROLLER BEARINGS

Bore Diameter 140 – 160 mm

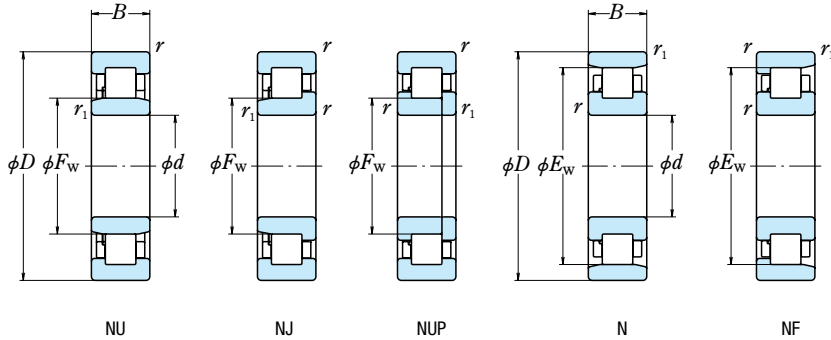

<i>d</i>	Boundary Dimensions (mm)						Basic Load Ratings (kN)	
	<i>D</i>	<i>B</i>	<i>r</i> min.	<i>r</i> ₁ min.	<i>F</i> _W	<i>E</i> _W	<i>C</i> _r	<i>C</i> _{0r}
140	190	30	1.5	1.1	153	177	151	258
	210	33	2	1.1	158	192	176	250
	210	53	2	2	160.1	—	300	525
	225	68	2.1	2.1	162.5	—	390	625
	250	42	3	3	—	221	297	375
	250	42	3	3	169	—	395	515
	250	68	3	3	169	—	550	790
	250	88	3	3	169	—	635	990
	300	62	4	4	—	260	550	640
	300	62	4	4	180	—	665	795
	300	102	4	4	180	—	1 020	1 380
	300	118	4	4	180	260	1 090	1 550
	360	82	5	5	198	302	875	1 020
	150	210	28	2	1.1	165	195	164
210		36	2	1.1	165	—	204	335
225		35	2.1	1.5	169.5	205.5	202	294
270		45	3	3	—	238	345	435
270		45	3	3	182	—	450	595
270		73	3	3	182	—	635	930
270		96	3	3	182	—	725	1 150
320		65	4	4	—	277	590	690
320		65	4	4	193	—	760	920
320		108	4	4	193	—	1 160	1 600
320		128	4	4	193	—	1 180	1 700
380		85	5	5	213	—	930	1 120
160		220	36	2	1.1	175	205	208
	240	38	2.1	1.5	180	220	238	340
	290	48	3	3	—	255	430	570
	290	48	3	3	195	—	500	665
	290	80	3	3	193	—	810	1 190
	340	68	4	4	—	292	700	875
	340	68	4	4	204	—	860	1 050
	340	114	4	4	204	—	1 310	1 820
	340	136	4	4	208	292	1 240	1 850

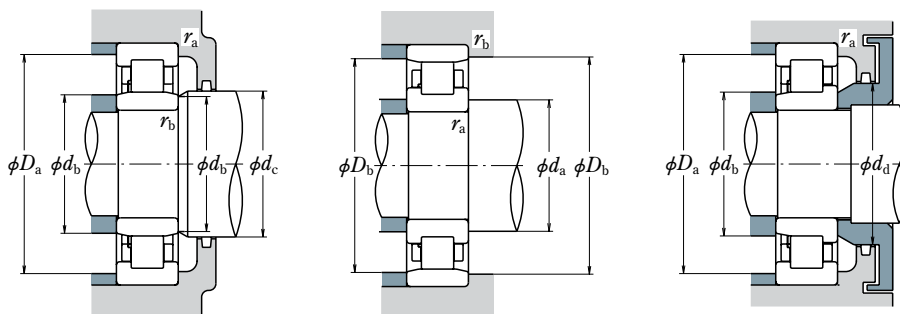

Bearing Numbers	Abutment and Fillet Dimensions (mm)							Mass (kg) approx.	
	d_a	d_b (¹)	d_c min.	d_d min.	D_a	D_b	r_a max.		r_b max.
NU2928	151	150	—	—	178	179	1.5	1	2.46
NU1028	149	156	161	—	201	194	2	1	3.87
NU3028	—	152	—	—	196	—	2	2	6.56
NU3128	—	155	—	—	209	—	2	2	10.6
N 228	153	—	—	—	—	225	2.5	2.5	8.08
NU 228 EM	153	165	171	182	237	—	2.5	2.5	9.38
NU2228 EM	153	165	171	182	237	—	2.5	2.5	15.2
NU3228	—	157	—	—	232	—	2.5	2.5	19.5
N 328	156	—	—	—	—	266	3	3	21.7
NU 328 EM	156	176	182	198	284	—	3	3	22.8
NU2328 EM	156	176	182	198	284	—	3	3	37.7
NU3328	160	160	—	—	278	278	3	3	42.2
NU 428	160	193	200	222	340	308	4	4	46.4
NU1930	163	160	—	—	196	199	2	1	2.98
NU2930	—	160	—	—	196	—	2	1	3.83
NU1030	161	167	173	—	214	208	2	1.5	4.77
N 230	163	—	—	—	—	242	2.5	2.5	10.4
NU 230 EM	163	177	184	196	257	—	2.5	2.5	11.9
NU2230 EM	163	177	184	196	257	—	2.5	2.5	19.3
NU3230	—	167	—	—	251	—	2.5	2.5	25.1
N 330	166	—	—	—	—	283	3	3	25.8
NU 330 EM	166	188	195	213	304	—	3	3	27.1
NU2330 EM	166	188	195	213	304	—	3	3	45.1
NU3330	—	170	—	—	297	—	3	3	53
NU 430	170	208	216	237	360	—	4	4	55.8
NU2932	173	170	—	—	206	209	2	1	4.08
NU1032	171	178	184	—	229	222	2	1.5	5.81
N 232	173	—	—	—	—	261	2.5	2.5	14.1
NU 232 EM	173	190	197	210	277	—	2.5	2.5	14.7
NU2232 EM	173	188	197	210	277	—	2.5	2.5	24.5
N 332	176	—	—	—	—	298	3	3	30.8
NU 332 EM	176	199	211	228	324	—	3	3	32.1
NU2332 EM	176	199	211	228	324	—	3	3	53.9
NU3332	180	180	—	—	317	317	3	3	63

Notes (¹) d_b are values for adjusting ring for NU, NJ types.

SINGLE-ROW CYLINDRICAL ROLLER BEARINGS

Bore Diameter 170 – 180 mm

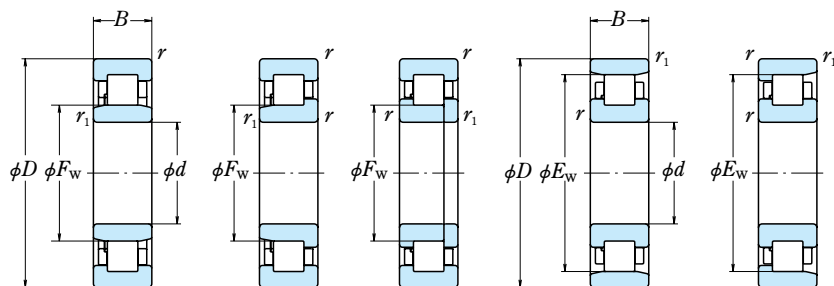

NU

NJ

NUP

N

NF

<i>d</i>	Boundary Dimensions (mm)						Basic Load Ratings (kN)	
	<i>D</i>	<i>B</i>	<i>r</i> min.	<i>r</i> ₁ min.	<i>F</i> _W	<i>E</i> _W	<i>C</i> _r	<i>C</i> _{0r}
170	215	34	1.1	1	181.5	203.5	187	385
	230	36	2	1.1	185	215	211	360
	260	42	2.1	2.1	193	237	287	415
	260	67	2.1	2.1	193	—	510	875
	280	88	2.1	2.1	200	—	665	1 080
	310	52	4	4	—	272	475	635
	310	52	4	4	207	—	605	800
	310	86	4	4	205	—	925	1 330
	310	110	4	4	208	—	915	1 470
	360	72	4	4	—	310	795	1 010
	360	72	4	4	218	—	930	1 150
	360	120	4	4	216	—	1 490	2 070
	360	140	4	4	220	310	1 350	1 980
	180	225	34	1.1	1	191.5	213.5	192
250		33	2	1.1	198	—	219	355
250		42	2	1.1	198	232	255	430
280		46	2.1	2.1	205	255	355	510
280		74	2.1	2.1	206	—	565	955
320		52	4	4	—	282	495	675
320		52	4	4	217	—	625	850
320		86	4	4	215	—	1 010	1 510
320		112	4	4	218	—	950	1 560
380		75	4	4	—	328	905	1 150
380		75	4	4	231	—	985	1 230
380		126	4	4	227	—	1 560	2 220
380		150	4	4	232	328	1 600	2 410

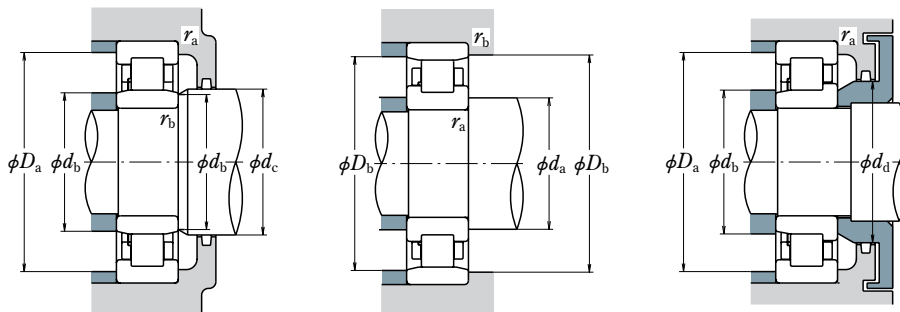

Bearing Numbers	Abutment and Fillet Dimensions (mm)								Mass (kg) approx.
	d_a	d_b ⁽¹⁾	d_c min.	d_d min.	D_a	D_b	r_a max.	r_b max.	
NU3834	181	179	—	—	204	205	1	1	2.99
NU2934	183	181	—	—	216	219	2	1	4.24
NU1034	181	190	197	—	249	239	2	2	7.91
NU3034	—	185	—	—	244	—	2	2	13.4
NU3134	—	185	—	—	263	—	2	2	22
N 234	186	—	—	—	—	278	3	3	17.4
NU 234 EM	186	202	211	223	294	—	3	3	18.3
NU2234 EM	186	200	211	223	294	—	3	3	29.9
NU3234	—	190	—	—	288	—	3	3	37.9
N 334	186	—	—	—	—	316	3	3	36.6
NU 334 EM	186	213	223	241	344	—	3	3	37.9
NU2334 EM	186	210	223	241	344	—	3	3	63.4
NU3334	190	190	—	—	337	337	3	3	72.1
NU3836	191	189	—	—	214	215	1	1	3.15
NU1936	—	191	—	—	236	—	2	1	4.92
NU2936	193	191	—	—	236	238	2	1	6.18
NU1036	191	202	209	—	269	258	2	2	10.2
NU3036	—	195	—	—	263	—	2	2	17.4
N 236	196	—	—	—	—	288	3	3	18.1
NU 236 EM	196	212	221	233	304	—	3	3	19
NU2236 EM	196	210	221	233	304	—	3	3	31.4
NU3236	—	200	—	—	297	—	3	3	39.6
N 336	196	—	—	—	—	335	3	3	42.6
NU 336 EM	196	226	235	255	364	—	3	3	44
NU2336 EM	196	222	235	255	364	—	3	3	74.6
NU3336	200	200	—	—	356	356	3	3	86.4

Notes ⁽¹⁾ d_b are values for adjusting ring for NU, NJ types.

SINGLE-ROW CYLINDRICAL ROLLER BEARINGS

Bore Diameter 190 – 220 mm

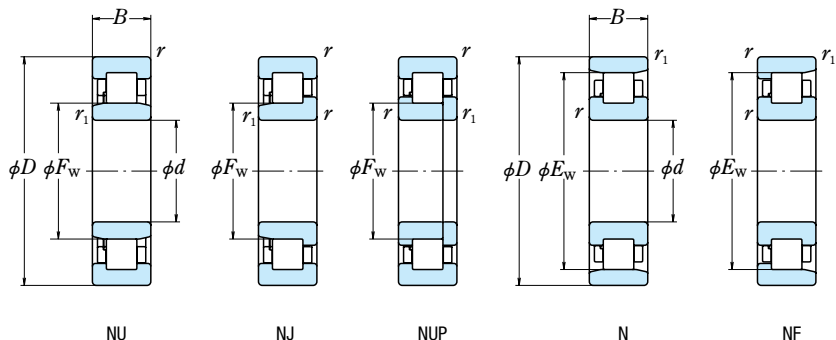

<i>d</i>	Boundary Dimensions (mm)						Basic Load Ratings (kN)		
	<i>D</i>	<i>B</i>	<i>r</i> min.	<i>r</i> ₁ min.	<i>F</i> _w	<i>E</i> _w	<i>C</i> _r	<i>C</i> _{0r}	
190	240	30	1.5	1.5	203	—	180	355	
	260	42	2	1.1	208	242	260	450	
	290	46	2.1	2.1	215	265	365	535	
	290	75	2.1	2.1	219	—	565	1 010	
	340	55	4	4	—	299	555	770	
	340	55	4	4	230	—	695	955	
	340	92	4	4	228	—	1 100	1 670	
	340	120	4	4	231	299	1 070	1 780	
	400	78	5	5	—	345	975	1 260	
	400	78	5	5	245	—	1 060	1 340	
	400	132	5	5	240	—	1 770	2 520	
	400	155	5	5	245	345	1 730	2 630	
	200	280	38	2.1	2.1	220	—	268	425
		280	48	2.1	1.5	220	260	365	630
310		51	2.1	2.1	229	281	390	580	
340		112	3	3	233	313	1 190	1 850	
360		58	4	4	—	316	620	865	
360		58	4	4	243	—	765	1 060	
360		98	4	4	241	—	1 220	1 870	
360		128	4	4	244	—	1 100	1 810	
420		80	5	5	—	360	975	1 270	
420		80	5	5	258	—	1 140	1 450	
420		138	5	5	253	—	1 910	2 760	
420		165	5	5	260	—	1 730	2 660	
220		300	38	2.1	1.5	240	280	295	495
		300	48	2.1	1.5	240	280	370	660
	340	56	3	3	250	310	500	750	
	340	90	3	3	254	—	795	1 430	
	400	65	4	4	—	350	760	1 080	
	400	65	4	4	270	—	760	1 080	
	400	108	4	4	270	—	1 140	1 810	
	400	144	4	4	270	350	1 480	2 530	
	460	88	5	5	—	396	1 190	1 570	
	460	88	5	5	284	—	1 190	1 570	
	460	180	5	5	284	—	2 120	3 300	

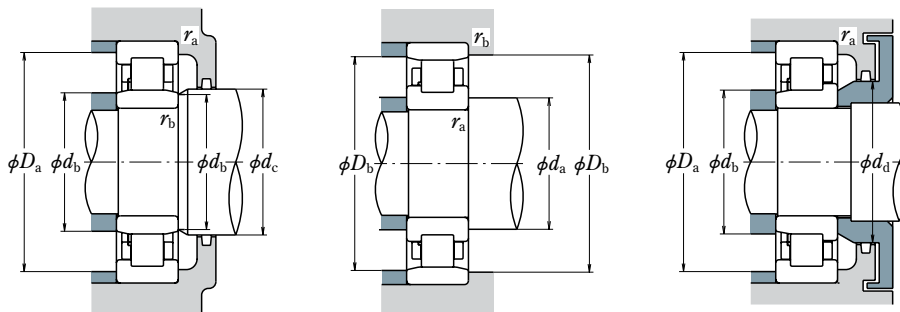

Bearing Numbers	Abutment and Fillet Dimensions (mm)								Mass (kg) approx.
	d_a	d_b (¹)	d_c min.	d_d min.	D_a	D_b	r_a max.	r_b max.	
NU2838	—	202	—	—	227	—	1.5	1.5	3.22
NU2938	203	201	—	—	245	248	2	1	6.42
NU1038	201	212	219	—	279	268	2	2	10.7
NU3038	—	206	—	—	273	—	2	2	18.3
N 238	206	—	—	—	—	305	3	3	22
NU 238 EM	206	225	234	247	324	—	3	3	23
NU2238 EM	206	223	234	247	324	—	3	3	38.3
NU3238	211	211	—	—	317	317	3	3	49.3
N 338	210	—	—	—	—	352	4	4	48.7
NU 338 EM	210	240	248	268	380	—	4	4	50.6
NU2338 EM	210	235	248	268	380	—	4	4	86.2
NU3338	215	215	—	—	372	372	4	4	99.2
NU1940	—	216	—	—	263	—	2	2	7.22
NU2940	216	213	—	—	263	266	2	1.5	9.24
NU1040	211	226	233	—	299	284	2	2	14
NU3140	218	218	—	—	320	320	2.5	2.5	41.4
N 240	216	—	—	—	—	323	3	3	26.2
NU 240 EM	216	238	247	261	344	—	3	3	27.4
NU2240 EM	216	235	247	261	344	—	3	3	46.1
NU3240	—	221	—	—	337	—	3	3	58
N 340	220	—	—	—	—	367	4	4	55.3
NU 340 EM	220	252	263	283	400	—	4	4	57.1
NU2340 EM	220	247	263	283	400	—	4	4	99.3
NU3340	—	225	—	—	392	—	4	4	115
NU1944	236	233	—	—	283	286	2	1.5	7.88
NU2944	236	233	—	—	283	286	2	1.5	9.93
NU1044	233	247	254	—	327	313	2.5	2.5	18.2
NU3044	—	238	—	—	320	—	2.5	2.5	30.6
N 244	236	—	—	—	—	357	3	3	37
NU 244	236	264	273	289	384	—	3	3	37.3
NU2244	—	264	273	289	384	—	3	3	61.8
NU3244	241	241	—	—	376	376	3	3	83.6
N 344	240	—	—	—	—	403	4	4	72.8
NU 344	240	278	287	307	440	—	4	4	74.6
NU3344	—	245	—	—	431	—	4	4	151

Notes (¹) d_b are values for adjusting ring for NU, NJ types.

SINGLE-ROW CYLINDRICAL ROLLER BEARINGS

Bore Diameter 240 – 280 mm

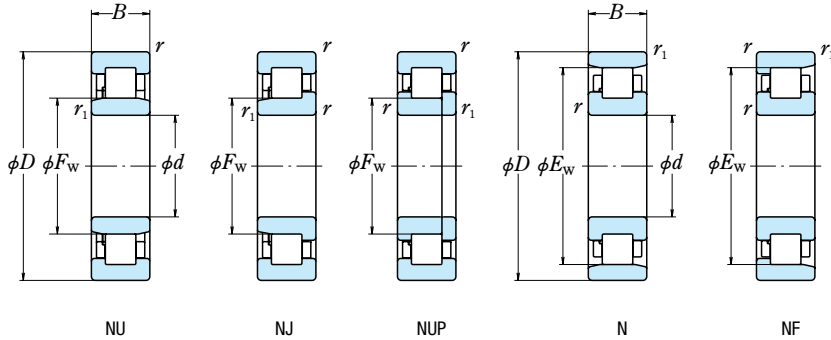

<i>d</i>	Boundary Dimensions (mm)						Basic Load Ratings (kN)		
	<i>D</i>	<i>B</i>	<i>r</i> min.	<i>r</i> ₁ min.	<i>F</i> _w	<i>E</i> _w	<i>C</i> _r	<i>C</i> _{0r}	
240	300	45	2	1.1	256	284	310	695	
	320	38	2.1	1.5	260	—	315	550	
	320	48	2.1	1.5	260	300	385	710	
	360	56	3	3	270	330	530	820	
	360	92	3	3	274	—	880	1 670	
	440	72	4	4	—	385	935	1 340	
	440	72	4	4	295	—	935	1 340	
	440	120	4	4	295	—	1 440	2 320	
	440	160	4	4	295	385	1 810	3 150	
	500	95	5	5	—	430	1 360	1 820	
	500	95	5	5	310	—	1 360	1 820	
	260	360	46	2.1	2.1	286	334	435	760
		360	60	2.1	2.1	286	334	535	995
		400	65	4	4	296	364	645	1 000
480		80	5	5	—	420	1 100	1 580	
480		80	5	5	320	—	1 100	1 580	
480		130	5	5	320	—	1 710	2 770	
480		174	5	5	320	—	2 110	3 650	
540		102	6	6	336	—	1 540	2 090	
540		206	6	6	336	—	2 730	4 350	
280		350	42	2	2	299	—	325	705
		350	52	2	1.1	298	—	435	985
		380	46	2.1	2.1	306	—	450	815
	380	60	2.1	2.1	307	—	575	1 150	
	420	65	4	4	316	384	660	1 050	
	420	106	4	4	320	384	1 090	2 110	
	500	80	5	5	—	440	1 140	1 680	
	500	80	5	5	340	—	1 140	1 680	
	580	224	6	6	360	500	3 200	5 200	

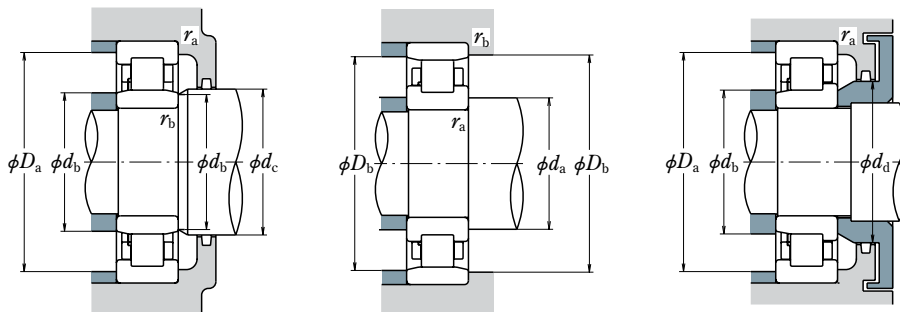

Bearing Numbers	Abutment and Fillet Dimensions (mm)								Mass (kg) approx.
	d_a	d_b (¹)	d_c min.	d_d min.	D_a	D_b	r_a max.	r_b max.	
NU3848	254	252	—	—	285	287	2	1	7.43
NU1948	—	253	—	—	302	—	2	1.5	8.68
NU2948	257	253	—	—	302	305	2	1.5	10.7
NU1048	253	266	275	—	347	333	2.5	2.5	19.5
NU3048	—	259	—	—	340	—	2.5	2.5	34.5
N 248	256	—	—	—	—	392	3	3	49.6
NU 248	256	289	298	316	424	—	3	3	50.4
NU2248	—	289	298	316	424	—	3	3	84.9
NU3248	262	262	—	—	415	415	3	3	110
N 348	260	—	—	—	—	438	4	4	92.3
NU 348	260	304	313	333	480	—	4	4	94.6
NU1952	277	277	—	—	342	342	2	2	14.4
NU2952	277	277	—	—	342	342	2	2	18.6
NU1052	276	292	300	—	384	367	3	3	29.1
N 252	280	—	—	—	—	428	4	4	66.2
NU 252	280	314	323	343	460	—	4	4	67.1
NU2252	280	314	323	343	460	—	4	4	111
NU3252	—	286	—	—	450	—	4	4	147
NU 352	286	330	339	359	514	—	5	5	118
NU3352	—	292	—	—	503	—	5	5	240
NU2856	—	295	—	—	334	—	2	2	9.16
NU3856	—	293	—	—	334	—	2	1	11.6
NU1956	—	297	—	—	361	—	2	2	15.2
NU2956	—	297	—	—	361	—	2	2	20.2
NU1056	296	312	320	—	404	387	3	3	30.8
NU3056	302	302	—	—	395	395	3	3	52
N 256	300	—	—	—	—	448	4	4	69.6
NU 256	300	334	344	364	480	—	4	4	70.7
NU3356	313	313	—	—	542	542	5	5	300

Notes (¹) d_b are values for adjusting ring for NU, NJ types.

SINGLE-ROW CYLINDRICAL ROLLER BEARINGS

Bore Diameter 300 – 400 mm

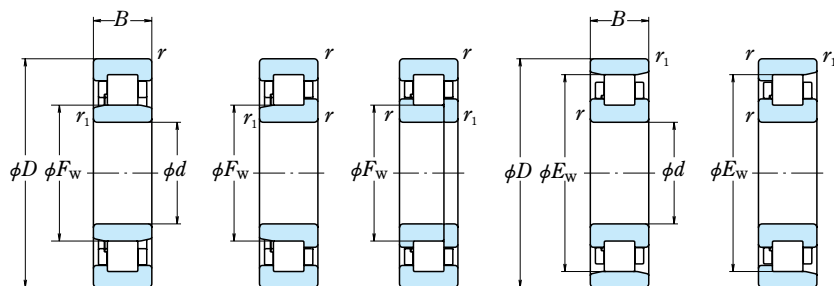

NU

NJ

NUP

N

NF

Boundary Dimensions
(mm)

Basic Load Ratings
(kN)

<i>d</i>	<i>D</i>	<i>B</i>	Boundary Dimensions (mm)		<i>F_w</i>	<i>E_w</i>	Basic Load Ratings (kN)	
			<i>r</i> min.	<i>r</i> ₁ min.			<i>C_r</i>	<i>C</i> _{0r}
300	380	60	2.1	2.1	322	—	485	1 110
	420	56	3	3	332	—	555	975
	420	72	3	3	332	388	725	1 370
	460	74	4	4	340	420	885	1 400
	540	85	5	5	364	—	1 400	2 070
	540	192	5	5	365	—	2 490	4 350
320	440	56	3	3	352	408	580	1 050
	440	72	3	3	352	408	755	1 470
	480	74	4	4	360	440	905	1 470
	480	121	4	4	364	436	1 360	2 690
	540	176	5	5	374	—	2 740	4 700
	580	92	5	5	—	510	1 540	2 270
	580	92	5	5	390	—	1 540	2 270
	580	208	5	5	388	512	2 790	4 750
340	420	48	2.1	1.5	362	—	435	1 010
	420	60	2.1	2.1	362	—	515	1 250
	460	56	3	3	372	—	600	1 120
	460	72	3	3	372	428	780	1 570
	520	82	5	5	385	475	1 080	1 740
	580	190	5	5	399	—	3 500	6 250
360	440	60	2.1	2.1	382	—	525	1 300
	480	56	3	3	392	—	605	1 160
	480	72	3	3	392	448	790	1 630
	540	82	5	5	405	495	1 110	1 830
	650	232	6	6	435	—	3 650	6 400
380	520	65	4	4	418	482	775	1 470
	560	82	5	5	425	—	1 140	1 910
	560	135	5	5	433	—	1 740	3 600
	620	194	5	5	440	—	3 350	6 400
400	500	75	2.1	2.1	427	—	785	1 900
	540	65	4	4	438	502	785	1 520
	540	82	4	4	438	502	1 060	2 250
	600	90	5	5	450	550	1 360	2 280
	600	148	5	5	458	548	2 150	4 450

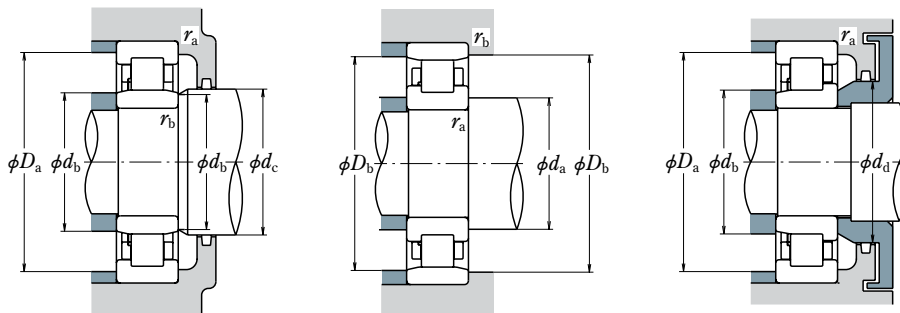

Bearing Numbers	Abutment and Fillet Dimensions (mm)								Mass (kg) approx.
	d_a	d_b (¹)	d_c min.	d_d min.	D_a	D_b	r_a max.	r_b max.	
NU3860	—	318	—	—	361	—	2	2	16.6
NU1960	—	320	—	—	398	—	2.5	2.5	24.4
NU2960	320	320	—	—	398	398	2.5	2.5	31.4
NU1060	316	336	344	—	444	424	3	3	43.7
NU260	320	358	368	391	520	—	4	4	89.2
NU3260	—	327	—	—	509	—	4	4	198
NU1964	340	340	—	—	418	418	2.5	2.5	25.7
NU2964	340	340	—	—	418	418	2.5	2.5	33.5
NU1064	336	356	365	—	464	444	3	3	46.1
NU3064	343	343	—	—	454	454	3	3	78.6
NU3164	—	347	—	—	509	—	4	4	170
N 264	340	—	—	—	—	519	4	4	110
NU264	340	384	394	420	560	—	4	4	112
NU3264	347	347	—	—	548	548	4	4	240
NU2868	—	355	—	—	400	—	2	1.5	14.9
NU3868	—	359	—	—	400	—	2	2	18.6
NU1968	—	361	—	—	438	—	2.5	2.5	27.1
NU2968	361	361	—	—	438	438	2.5	2.5	35
NU1068	360	381	390	—	500	479	4	4	61.8
NU3168	—	368	—	—	548	—	4	4	214
NU3872	—	379	—	—	420	—	2	2	19.8
NU1972	—	381	—	—	457	—	2.5	2.5	28.8
NU2972	381	381	—	—	457	457	2.5	2.5	36.7
NU1072	380	400	410	—	520	499	4	4	64.6
NU3272	—	394	—	—	611	—	5	5	344
NU1976	404	404	—	—	493	493	3	3	41.2
NU1076	—	420	430	—	540	—	4	4	67.5
NU3076	—	408	—	—	529	—	4	4	117
NU3176	—	408	—	—	588	—	4	4	238
NU3880	—	420	—	—	479	—	2	2	34.3
NU1980	425	425	—	—	513	513	3	3	43
NU2980	425	425	—	—	513	513	3	3	54.9
NU1080	420	445	455	—	580	554.5	4	4	88.2
NU3080	429	429	—	—	568	568	4	4	150

Notes (¹) d_b are values for adjusting ring for NU, NJ types.

SINGLE-ROW CYLINDRICAL ROLLER BEARINGS

Bore Diameter 420 – 670 mm

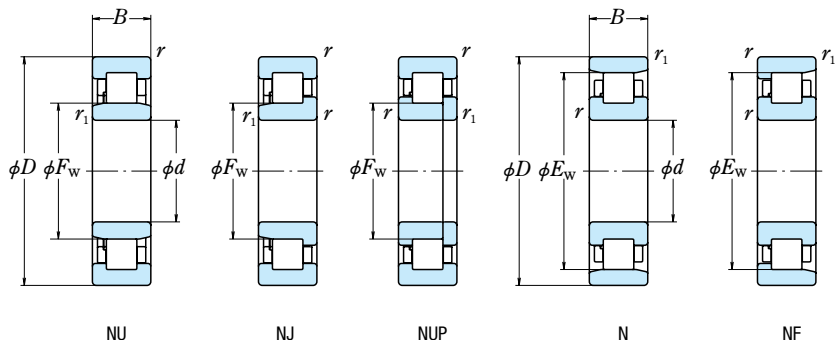

<i>d</i>	Boundary Dimensions (mm)						Basic Load Ratings (kN)	
	<i>D</i>	<i>B</i>	<i>r</i> min.	<i>r</i> ₁ min.	<i>F</i> _w	<i>E</i> _w	<i>C</i> _r	<i>C</i> _{0r}
420	520	75	2.1	2.1	447	—	800	1 990
	560	65	4	4	458	522	830	1 660
	560	82	4	4	458	522	1 080	2 320
420	90	5	5	470	570	1 390	2 380	
	150	5	5	478	568	2 190	4 600	
440	600	95	4	4	484	—	1 300	2 760
	650	94	6	6	493	—	1 470	2 530
460	620	74	4	4	500	580	1 170	2 260
	620	95	4	4	504	—	1 340	2 930
	680	100	6	6	516	624	1 580	2 740
	680	163	6	6	523	—	2 570	5 400
480	650	78	5	5	525	—	1 200	2 390
	650	100	5	5	525	605	1 600	3 450
	700	100	6	6	536	644	1 620	2 860
	700	165	6	6	543	—	2 620	5 600
500	720	100	6	6	556	664	1 660	2 970
	720	167	6	6	554	666	3 500	7 650
	920	336	7.5	7.5	610	810	7 950	15 200
530	710	82	5	5	575	—	1 460	2 910
	710	106	5	5	578	662	1 770	3 900
	980	355	9.5	9.5	645	865	9 150	17 400
560	680	72	3	3	594	646	985	2 610
	750	85	5	5	610	—	1 510	3 100
	920	280	7.5	7.5	650	—	7 150	14 500
600	730	78	3	3	635	695	1 180	3 050
	800	90	5	5	655	—	1 590	3 400
	800	118	5	5	655	745	2 160	5 000
630	780	88	4	4	671	—	1 450	3 700
	850	100	6	6	690	—	1 850	3 900
670	820	88	4	4	711	779	1 500	3 950
	820	112	4	4	711	—	1 920	5 200
	900	103	6	6	731	—	1 870	3 800

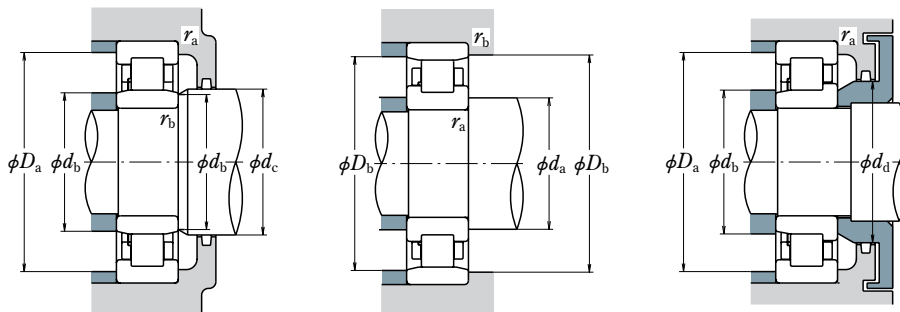

Bearing Numbers	Abutment and Fillet Dimensions (mm)							Mass (kg) approx.	
	d_a	d_b (¹)	d_c min.	d_d min.	D_a	D_b	r_a max.		r_b max.
NU3884	—	440	—	—	498	—	2	2	35.8
NU1984	445	445	—	—	533	533	3	3	45
NU2984	445	445	—	—	533	533	3	3	58.2
NU1084	440	465	475	—	600	574.5	4	4	91.7
NU3084	449	449	—	—	588	588	4	4	158
NU2988	—	466	—	—	572	—	3	3	79.9
NU1088	—	488	498	—	624	—	5	5	105
NU1992	486	486	—	—	591	591	3	3	63.2
NU2992	—	486	—	—	591	—	3	3	83.1
NU1092	486	511	521	—	654	628.5	5	5	123
NU3092	—	496	—	—	640	—	5	5	207
NU1996	—	510	—	—	617	—	4	4	75
NU2996	510	510	—	—	617	617	4	4	98.5
NU1096	506	531	541	—	674	654	5	5	127
NU3096	—	517	—	—	660	—	5	5	217
NU10/500	526	551	558	—	694	674	5	5	131
NU30/500	537	537	—	—	680	680	5	5	232
NU32/500	543	543	—	—	870	870	6	6	1 020
NU19/530	—	561	—	—	676	—	4	4	92
NU29/530	561	561	—	—	676	676	4	4	119
NU32/530	582	582	—	—	921	921	8	8	1 230
NU28/560	585	585	—	—	653	653	2.5	2.5	55.6
NU19/560	—	592	—	—	715	—	4	4	106
NU31/560	—	604	—	—	870	—	6	6	750
NU28/600	626	626	—	—	702	702	2.5	2.5	68
NU19/600	—	633	—	—	764	—	4	4	127
NU29/600	633	633	—	—	764	764	4	4	170
NU28/630	—	659	—	—	748	—	3	3	95.2
NU19/630	—	670	—	—	807	—	5	5	163
NU28/670	700	700	—	—	787	787	3	3	103
NU38/670	—	700	—	—	787	—	3	3	128
NU19/670	—	710	—	—	856	—	5	5	181

Notes (¹) d_b are values for adjusting ring for NU, NJ types.

SINGLE-ROW CYLINDRICAL ROLLER BEARINGS

Bore Diameter 710 – 1 320 mm

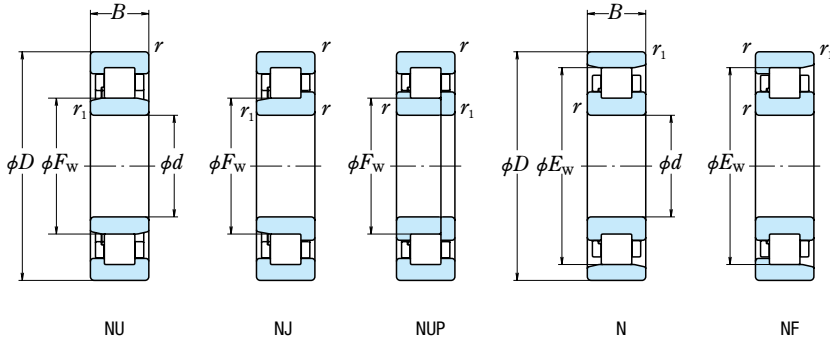

<i>d</i>	Boundary Dimensions (mm)						Basic Load Ratings (kN)	
	<i>D</i>	<i>B</i>	<i>r</i> min.	<i>r</i> ₁ min.	<i>F</i> _w	<i>E</i> _w	<i>C</i> _r	<i>C</i> _{0r}
710	950	106	6	6	775	—	2 300	5 000
	950	140	6	6	776	—	3 450	8 400
750	920	100	5	5	797	—	1 860	5 000
800	980	136	5	5	848	—	2 530	7 050
	1 060	115	6	6	870	—	2 760	6 150
850	1 030	106	5	5	900	—	2 130	5 950
	1 120	118	6	6	925	1 045	2 780	6 350
	1 120	155	6	6	917	—	4 450	10 500
900	1 090	112	5	5	950	—	2 580	7 100
	1 090	140	5	5	950	—	2 990	8 600
1 000	1 220	128	6	6	1 058	—	3 200	8 850
1 060	1 280	165	6	6	1 120	—	3 750	11 300
1 120	1 360	180	6	6	1 180	—	5 700	17 300
1 250	1 630	170	7.5	7.5	1 350	—	6 300	15 400
1 320	1 720	175	7.5	7.5	1 424	—	7 000	17 100

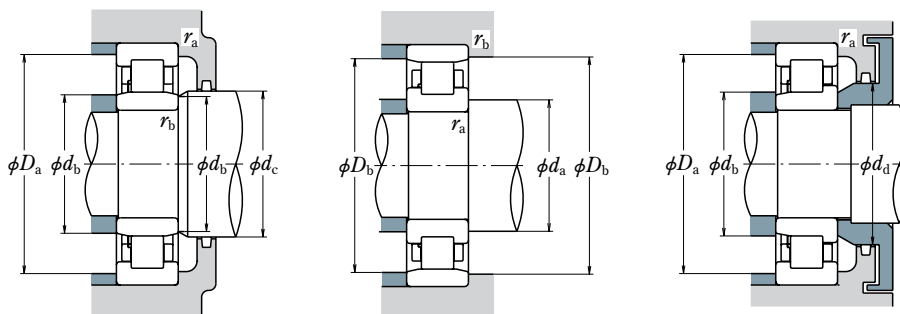

Bearing Numbers	Abutment and Fillet Dimensions (mm)							Mass (kg) approx.	
	d_a	d_b ⁽¹⁾	d_c min.	d_d min.	D_a	D_b	r_a max.		r_b max.
NU19/710	—	751	—	—	905	—	5	5	213
NU29/710	—	751	—	—	905	—	5	5	285
NU28/750	—	786	—	—	882	—	4	4	145
NU38/800	—	837	—	—	940	—	4	4	219
NU19/800	—	843	—	—	1 013	—	5	5	282
NU28/850	—	888	—	—	989	—	4	4	183
NU19/850	894	894	—	—	1 072	1 072	5	5	320
NU29/850	—	894	—	—	1 072	—	5	5	426
NU28/900	—	939	—	—	1 048	—	4	4	217
NU38/900	—	939	—	—	1 048	—	4	4	269
NU28/1000	—	1 047	—	—	1 170	—	5	5	319
NU38/1060	—	1 108	—	—	1 228	—	5	5	427
NU38/1120	—	1 169	—	—	1 307	—	5	5	547
NU19/1250	—	1 308	—	—	1 566	—	6	6	952
NU19/1320	—	1 380	—	—	1 654	—	6	6	1 100

Notes ⁽¹⁾ d_b are values for adjusting ring for NU, NJ types.

DOUBLE-ROW CYLINDRICAL ROLLER BEARINGS

Bore Diameter 100 – 140 mm

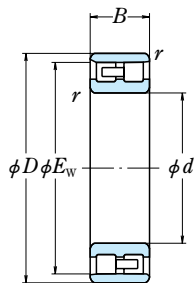

NN
Cylindrical Bore

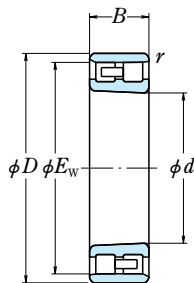

NN
Tapered Bore

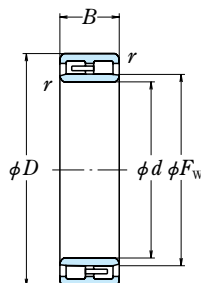

NNU
Cylindrical Bore

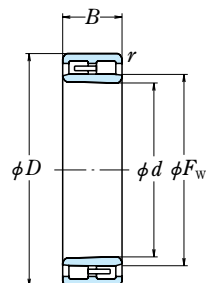

NNU
Tapered Bore

<i>d</i>	Boundary Dimensions (mm)					Basic Load Ratings				Bearing Numbers	
	<i>D</i>	<i>B</i>	<i>r</i> min.	<i>F_w</i>	<i>E_w</i>	<i>C_r</i> (kN)	<i>C_{0r}</i> (kgf)	<i>C_r</i>	<i>C_{0r}</i>	Cylindrical Bore	Tapered Bore (1)
100	140	30	1.1	—	130	106	182	10 800	18 500	NN3920	NN3920K
	140	40	1.1	—	130	155	295	15 800	30 000	NN4920	NN4920K
	140	40	1.1	112	—	155	295	15 800	30 000	NNU4920	NNU4920K
	150	37	1.5	—	137	157	265	16 000	27 000	NN3020	NN3020K
	165	52	1.1	—	148	234	360	23 900	37 000	NN3120	—
	165	52	2	118	—	234	360	23 900	37 000	NNU3120	—
105	145	40	1.1	—	135	161	315	16 400	32 000	NN4921	—
	145	40	1.1	117	—	161	315	16 400	32 000	NNU4921	NNU4921K
	160	41	2	—	146	198	320	20 200	33 000	NN3021	NN3021K
	160	41	2	120	—	198	320	20 200	33 000	NNU3021	NNU3021K
110	150	30	1.1	—	140	114	207	11 700	21 100	NN3922	NN3922K
	150	40	1.1	—	140	167	335	17 000	34 000	NN4922	NN4922K
	150	40	1.1	122	—	167	335	17 000	34 000	NNU4922	NNU4922K
	170	45	2	—	155	229	375	23 300	38 000	NN3022	NN3022K
	170	45	2	127	—	229	375	23 300	38 000	NNU3022	—
	180	56	1.1	—	163	290	450	29 600	45 500	NN3122	—
120	165	34	1.1	—	153	138	251	14 000	25 500	NN3924	NN3924K
	165	45	1.1	—	153	183	360	18 700	37 000	NN4924	NN4924K
	165	45	1.1	133	—	183	360	18 700	37 000	NNU4924	NNU4924K
	180	46	2	—	165	239	405	24 400	41 500	NN3024	NN3024K
	180	46	2	137	—	239	405	24 400	41 500	NNU3024	—
	200	62	2	—	180	355	550	36 000	56 000	NN3124	NN3124K
130	165	35	1	—	154	107	238	10 900	24 200	NN4826	—
	180	37	1.5	—	167	173	325	17 700	33 000	NN3926	NN3926K
	180	50	1.5	—	168	274	545	27 900	56 000	NN4926	NN4926K
	180	50	1.5	144	—	274	545	27 900	56 000	NNU4926	NNU4926K
	200	52	2	—	182	284	475	29 000	48 500	NN3026	NN3026K
	200	52	2	150	—	284	475	29 000	48 500	NNU3026	NNU3026K
	210	64	2	152	—	360	580	37 000	59 500	NNU3126	—
	210	64	2	—	192	298	515	30 500	52 500	NN3028	NN3028K
140	190	37	1.5	—	178	201	375	20 500	38 500	NN3928	NN3928K
	190	50	1.5	—	178	283	585	28 800	59 500	NN4928	NN4928K
	190	50	1.5	154	—	283	585	28 800	59 500	NNU4928	NNU4928K
	210	53	2	—	192	298	515	30 500	52 500	NN3028	NN3028K
	210	53	2	160	—	298	515	30 500	52 500	NNU3028	—
	225	68	2.1	—	203	400	650	40 500	66 000	NN3128	—
	225	68	2.1	163	—	400	650	40 500	66 000	NNU3128	—

Note (1) The suffix K represents with tapered bores (taper 1:12).

Remarks Production of double-row cylindrical roller bearings is generally in the high precision classes (Class 5 or better).

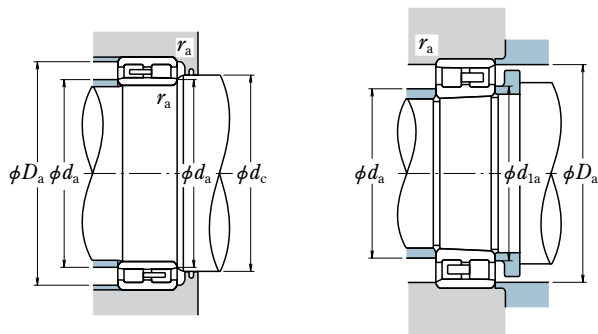

Abutment and Fillet Dimensions (mm)					Mass (kg)
$d_a^{(2)}$	d_{1a}	d_c min.	D_a	r_a max.	approx.
109	111	—	131	1	1.32
109	111	—	131	1	1.76
109	111	115	131	1	1.9
111	114	—	139	1.5	2.28
109	—	—	155	1	4.38
112	—	122	152	2	4.39
114	—	—	136	1	2.0
114	116	120	136	1	1.99
117	119	—	147	2	2.88
117	119	123	147	2	2.9
119	121	—	141	1	1.41
119	121	—	141	1	2.1
119	121	125	141	1	2.07
122	126	—	157	2	3.71
122	—	130	157	2	3.74
119	—	—	170	1	5.4
130	132	—	155	1	2.02
130	133	—	155	1	2.87
130	133	137	155	1	2.85
132	136	—	167	2	4.04
132	—	140	167	2	4.07
132	137	—	187	2	7.72
138	—	—	156	1	1.82
141	144	—	168	1.5	2.59
141	143	—	169	1.5	3.84
141	143	148	169	1.5	3.85
142	147	—	187	2	5.88
142	147	154	187	2	5.92
142	—	157	196	2	8.49
151	153	—	179	1.5	2.78
151	153	—	179	1.5	4.07
151	153	158	179	1.5	4.08
152	157	—	196	2	6.34
152	—	164	196	2	6.38
155	—	—	209	2	10.1
155	—	168	209	2	10.3

Note ⁽²⁾ d_a are values for adjusting ring for the NNU type.

DOUBLE-ROW CYLINDRICAL ROLLER BEARINGS

Bore Diameter 150 – 190 mm

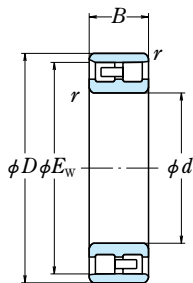

NN
Cylindrical Bore

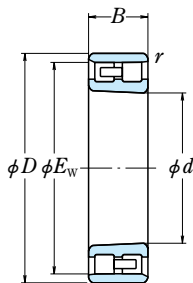

NN
Tapered Bore

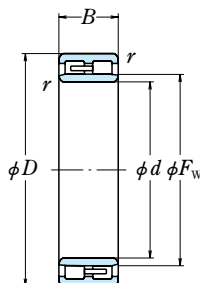

NNU
Cylindrical Bore

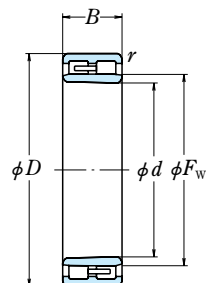

NNU
Tapered Bore

	Boundary Dimensions (mm)					Basic Load Ratings (kN) (kgf)				Bearing Numbers	
	d	D	B	r min.	F_w E_w	C_r	C_{0r}	C_r	C_{0r}	Cylindrical Bore	Tapered Bore (1)
150	210	45	2	—	195	262	490	26 700	49 500	NN3930	NN3930K
	210	60	2	—	195	350	715	36 000	72 500	NN4930	NN4930K
	210	60	2	167	—	350	715	36 000	72 500	NNU4930	NNU4930K
	225	56	2.1	—	206	335	585	34 000	60 000	NN3030	NN3030K
	225	56	2.1	172	—	335	585	34 000	60 000	NNU3030	—
	250	80	2.1	—	226	535	860	54 500	87 500	NN3130	—
160	200	40	1	—	188	150	355	15 300	36 000	NN4832	—
	220	45	2	—	205	271	520	27 700	53 000	NN3932	NN3932K
	220	60	2	—	205	365	760	37 000	77 500	NN4932	NN4932K
	220	60	2	177	—	365	760	37 000	77 500	NNU4932	NNU4932K
	240	60	2.1	—	219	375	660	38 000	67 500	NN3032	NN3032K
	240	60	2.1	183	—	375	660	38 000	67 500	NNU3032	—
	240	80	2.1	—	219	510	985	52 000	100 000	NN4032	NN4032K
	240	80	2.1	183	—	510	985	52 000	100 000	NNU4032	—
	270	86	2.1	—	243	620	1 000	63 000	102 000	NN3132	—
	170	230	45	2	—	215	280	550	28 600	56 000	NN3934
230		60	2	—	215	375	805	38 500	82 000	NN4934	NN4934K
230		60	2	187	—	375	805	38 500	82 000	NNU4934	NNU4934K
260		67	2.1	—	236	450	805	46 000	82 000	NN3034	NN3034K
260		67	2.1	196	—	450	805	46 000	82 000	NNU3034	NNU3034K
280		88	2.1	—	253	635	1 050	65 000	107 000	NN3134	—
180	280	88	2.1	201	—	635	1 050	65 000	107 000	NNU3134	—
	225	45	1	—	213	225	535	22 900	54 500	NN4836	—
	250	52	2	—	232	340	655	34 500	67 000	NN3936	NN3936K
	250	69	2	—	232	480	1 020	49 000	104 000	NN4936	NN4936K
	250	69	2	200	—	480	1 020	49 000	104 000	NNU4936	NNU4936K
	280	74	2.1	—	255	565	995	57 500	102 000	NN3036	NN3036K
190	280	74	2.1	209	—	565	995	57 500	102 000	NNU3036	—
	260	52	2	—	243	345	680	35 000	69 000	NN3938	NN3938K
	260	69	2	—	243	485	1 060	49 500	108 000	NN4938	NN4938K
	260	69	2	211	—	485	1 060	49 500	108 000	NNU4938	NNU4938K
	290	75	2.1	—	265	595	1 080	60 500	110 000	NN3038	NN3038K
	290	75	2.1	219	—	595	1 080	60 500	110 000	NNU3038	—
	290	100	2.1	—	265	825	1 640	84 000	167 000	NN4038	—
	320	104	3	—	287	840	1 420	85 500	144 000	NN3138	—

Note (1) The suffix K represents with tapered bores (taper 1:12).

Remarks Production of double-row cylindrical roller bearings is generally in the high precision classes (Class 5 or better).

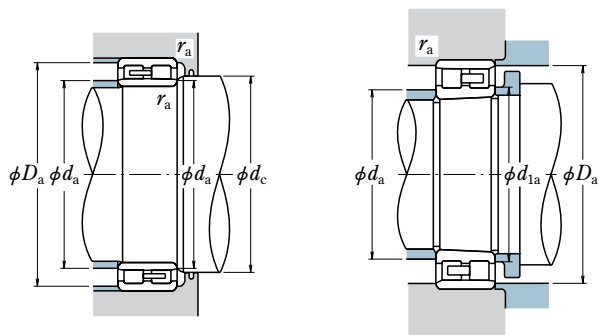

Abutment and Fillet Dimensions (mm)					Mass (kg)
$d_a^{(2)}$	d_{1a}	d_c min.	D_a	r_a max.	approx.
163	166	—	196	2	4.47
163	166	—	196	2	6.36
163	166	171	196	2	6.39
165	169	—	209	2	7.77
165	—	176	209	2	7.81
165	—	—	234	2	15.4
169	—	—	191	1	2.95
173	176	—	206	2	5.02
173	176	—	206	2	6.77
173	176	182	206	2	6.76
175	180	—	224	2	9.41
175	—	188	224	2	9.48
175	182	—	224	2	12.7
175	—	188	224	2	12.7
175	—	—	253	2	19.8
183	186	—	216	2	5.01
183	186	—	216	2	7.13
183	186	192	216	2	7.12
185	191	—	244	2	12.8
185	191	201	244	2	12.9
185	—	—	263	2	21.1
185	—	206	263	2	21.4
189	—	—	215	1	4.15
193	198	—	236	2	7.2
193	199	—	236	2	10.4
193	199	205	236	2	10.4
195	202	—	263	2	16.8
195	—	214	263	2	16.9
203	208	—	245	2	7.46
203	209	—	245	2	10.9
203	209	217	245	2	10.9
206	212	—	273	2	17.8
206	—	224	273	2	17.9
206	—	—	273	2	24
208	—	—	300	2.5	33.8

Note ⁽²⁾ d_a are values for adjusting ring for the NNU type.

DOUBLE-ROW CYLINDRICAL ROLLER BEARINGS

Bore Diameter 200 – 260 mm

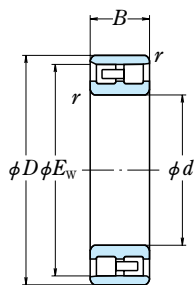

NN
Cylindrical Bore

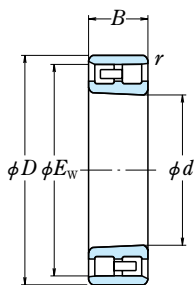

NN
Tapered Bore

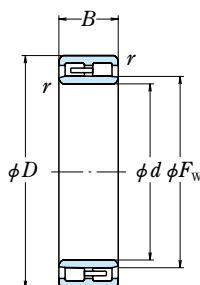

NNU
Cylindrical Bore

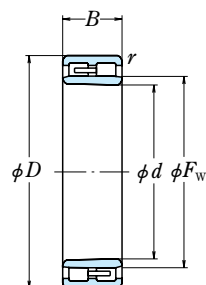

NNU
Tapered Bore

d	Boundary Dimensions (mm)					Basic Load Ratings (kN / kgf)				Bearing Numbers	
	D	B	r min.	F _W	E _W	C _r	C _{0r}	C _r	C _{0r}	Cylindrical Bore	Tapered Bore (1)
200	280	60	2.1	—	259	420	815	42 500	83 500	NN3940	NN3940K
	280	80	2.1	—	259	570	1 220	58 000	124 000	NN4940	NN4940K
	280	80	2.1	223	—	570	1 220	58 000	124 000	NNU4940	NNU4940K
310	310	82	2.1	—	282	655	1 170	66 500	119 000	NN3040	NN3040K
	310	82	2.1	232	—	655	1 170	66 500	119 000	NNU3040	NNU3040K
	310	109	2.1	—	282	890	1 730	90 500	177 000	NN4040	NN4040K
220	300	60	2.1	—	279	440	895	45 000	91 500	NN3944	NN3944K
	300	80	2.1	—	279	600	1 330	61 000	136 000	NN4944	NN4944K
	300	80	2.1	243	—	600	1 330	61 000	136 000	NNU4944	NNU4944K
340	340	90	3	—	310	815	1 480	83 000	151 000	NN3044	NN3044K
	340	90	3	254	—	815	1 480	83 000	151 000	NNU3044	—
	340	118	3	—	310	1 190	2 400	121 000	245 000	NN4044	NN4044K
370	370	120	4	—	331	1 050	1 810	107 000	184 000	NN3144	—
	370	120	4	263	—	1 050	1 810	107 000	184 000	NNU3144	—
240	300	60	1.1	—	283	405	1 030	41 500	105 000	NN4848	—
	320	60	2.1	—	300	460	975	47 000	99 000	NN3948	NN3948K
	320	80	2.1	—	300	625	1 450	63 500	148 000	NN4948	NN4948K
320	320	80	2.1	263	—	625	1 450	63 500	148 000	NNU4948	NNU4948K
	360	92	3	—	330	855	1 600	87 000	163 000	NN3048	NN3048K
	360	92	3	274	—	855	1 600	87 000	163 000	NNU3048	NNU3048K
360	360	118	3	—	330	1 240	2 600	127 000	266 000	NN4048	NN4048K
	360	118	3	274	—	1 240	2 600	127 000	266 000	NNU4048	—
	400	128	4	—	358	1 170	2 040	119 000	208 000	NN3148	NN3148K
260	360	75	2.1	—	335	670	1 380	68 500	141 000	NN3952	NN3952K
	360	100	2.1	—	335	935	2 100	95 000	214 000	NN4952	NN4952K
	360	100	2.1	289	—	935	2 100	95 000	214 000	NNU4952	NNU4952K
400	400	104	4	—	364	1 030	1 920	105 000	196 000	NN3052	NN3052K
	400	104	4	300	—	1 030	1 920	105 000	196 000	NNU3052	—
	400	140	4	—	364	1 550	3 250	158 000	330 000	NN4052	NN4052K
400	400	140	4	300	—	1 550	3 250	158 000	330 000	NNU4052	—
	440	144	4	—	393	1 480	2 660	151 000	271 000	NN3152	NN3152K

Note (1) The suffix K represents with tapered bores (taper 1:12).

Remarks Production of double-row cylindrical roller bearings is generally in the high precision classes (Class 5 or better).

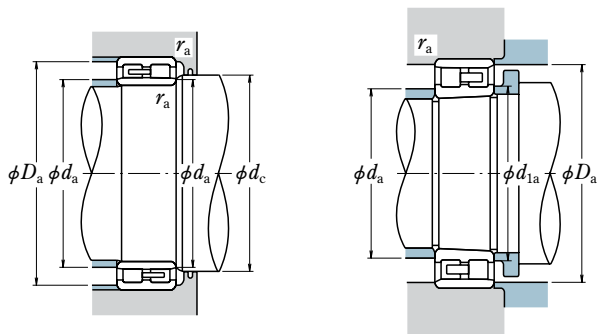

Abutment and Fillet Dimensions (mm)					Mass (kg)
$d_a^{(2)}$	d_{1a}	d_c min.	D_a	r_a max.	approx.
216	221	—	263	2	10.6
216	222	—	263	2	15.3
216	222	228	263	2	15.3
216	223	—	293	2	22.7
216	223	237	293	2	22.9
216	225	—	293	2	30.4
236	241	—	283	2	11.4
236	242	—	283	2	16.6
236	242	248	283	2	16.6
238	246	—	320	2.5	29.6
238	—	259	320	2.5	30
238	248	—	320	2.5	39.8
241	—	—	346	3	51.9
241	—	268	346	3	52.3
252	—	—	287	1	9.77
257	262	—	302	2	12.2
257	263	—	302	2	17.9
257	262	269	302	2	18
259	266	—	340	2.5	32.7
259	266	280	340	2.5	30.8
259	269	—	340	2.5	39.3
259	—	281	340	2.5	42.7
262	272	—	376	3	64.2
277	283	—	342	2	21.4
277	285	—	342	2	28.3
277	285	295	342	2	31.1
282	291	—	376	3	47.7
282	—	306	376	3	48.1
282	294	—	376	3	59.7
282	—	306	376	3	65
282	294	—	415	3	89.1

Note ⁽²⁾ d_a are values for adjusting ring for the NNU type.

DOUBLE-ROW CYLINDRICAL ROLLER BEARINGS

Bore Diameter 280 – 360 mm

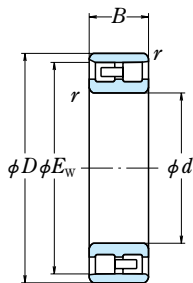

NN
Cylindrical Bore

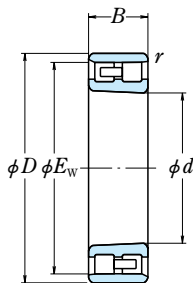

NN
Tapered Bore

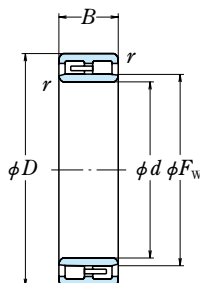

NNU
Cylindrical Bore

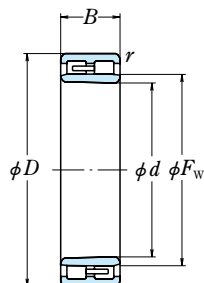

NNU
Tapered Bore

d	Boundary Dimensions (mm)					Basic Load Ratings (kN)				Bearing Numbers	
	D	B	r min.	F _w	E _w	C _r	C _{0r}	C _r	C _{0r}	Cylindrical Bore	Tapered Bore (1)
280	350	69	1.1	—	329	445	1 160	45 500	119 000	NN4856	—
	380	75	2.1	—	355	695	1 460	70 500	149 000	NN3956	NN3956K
	380	100	2.1	—	355	960	2 230	98 000	227 000	NN4956	NN4956K
	380	100	2.1	309	—	960	2 230	98 000	227 000	NNU4956	NNU4956K
	420	106	4	—	384	1 080	2 080	110 000	212 000	NN3056	NN3056K
	420	106	4	320	—	1 080	2 080	110 000	212 000	NNU3056	—
300	460	146	5	—	413	1 520	2 790	155 000	285 000	NN3156	NN3156K
	380	80	2.1	324	—	690	1 760	70 500	179 000	NNU4860	—
	420	118	3	—	388	1 230	2 870	125 000	293 000	NN4960	NN4960K
	420	118	3	336	—	1 230	2 870	125 000	293 000	NNU4960	NNU4960K
	460	118	4	—	418	1 290	2 460	132 000	251 000	NN3060	NN3060K
	460	160	4	—	418	1 920	4 100	196 000	420 000	NN4060	NN4060K
320	500	160	5	—	448	1 760	3 150	179 000	325 000	NN3160	NN3160K
	500	160	5	358	—	1 760	3 150	179 000	325 000	NNU3160	—
	400	80	2.1	344	—	700	1 840	71 500	187 000	NNU4864	—
	440	118	3	—	408	1 260	3 050	129 000	310 000	NN4964	NN4964K
	440	118	3	356	—	1 260	3 050	129 000	310 000	NNU4964	NNU4964K
	480	121	4	—	438	1 350	2 670	138 000	272 000	NN3064	NN3064K
340	480	121	4	366	—	1 350	2 670	138 000	272 000	NNU3064	NNU3064K
	480	160	4	367	—	1 960	4 300	200 000	435 000	NN4064	—
	540	176	5	384	—	2 090	3 750	213 000	385 000	NNU3164	NNU3164K
	460	90	3	—	428	905	2 020	92 500	206 000	NN3968	NN3968K
	460	118	3	—	428	1 350	3 400	138 000	345 000	NN4968	NN4968K
	460	118	3	376	—	1 350	3 400	138 000	345 000	NNU4968	—
360	520	133	5	—	473	1 670	3 300	170 000	340 000	NN3068	NN3068K
	520	133	5	393	—	1 670	3 300	170 000	340 000	NNU3068	—
	520	180	5	393	—	2 420	5 350	247 000	545 000	NNU4068	—
	480	90	3	—	448	930	2 130	95 000	217 000	NN3972	—
	480	118	3	396	—	1 390	3 550	142 000	365 000	NN4972	—
	540	134	5	—	493	1 700	3 450	173 000	350 000	NN3072	NN3072K
360	540	134	5	413	—	1 700	3 450	173 000	350 000	NNU3072	—
	540	180	5	—	496	2 530	5 450	258 000	555 000	NN4072	NN4072K

Note (1) The suffix K represents with tapered bores (taper 1:12).

Remarks Production of double-row cylindrical roller bearings is generally in the high precision classes (Class 5 or better).

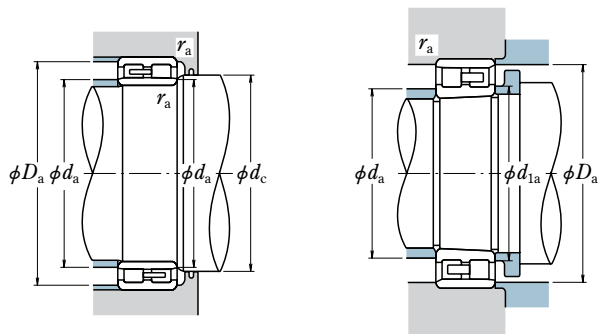

Abutment and Fillet Dimensions (mm)					Mass (kg)
$d_a^{(2)}$	d_{1a}	d_c min.	D_a	r_a max.	approx.
293	—	—	336	1	15.3
297	304	—	361	2	22.7
297	306	—	361	2	32.9
297	306	315	361	2	33
302	311	—	395	3	51.1
302	—	326	395	3	51.4
306	319	—	431	4	95.7
318	—	331	361	2	21.7
320	330	—	398	2.5	51.6
320	330	343	398	2.5	51.9
323	333	—	435	3	70.7
323	336	—	435	3	97.6
327	340	—	470	4	125
327	—	365	470	4	126
338	—	351	381	2	22.8
340	350	—	418	2.5	50.2
340	350	363	418	2.5	54.9
343	354	—	454	3	76.6
343	354	373	454	3	76.9
343	—	374	454	3	103
347	362	391	509	4	154
361	368	—	438	2.5	42.9
361	371	—	438	2.5	52.1
361	—	383	438	2.5	57.8
368	379	—	490	4	102
368	—	400	490	4	103
368	—	400	490	4	141
381	—	—	457	2.5	44.9
381	—	403	457	2.5	60.6
388	399	—	509	4	106
388	—	420	509	4	108
388	403	—	509	4	132

Note ⁽²⁾ d_a are values for adjusting ring for the NNU type.

DOUBLE-ROW CYLINDRICAL ROLLER BEARINGS

Bore Diameter 380 – 480 mm

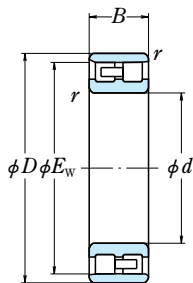

NN
Cylindrical Bore

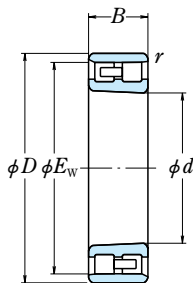

NN
Tapered Bore

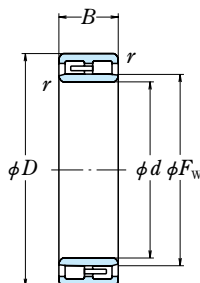

NNU
Cylindrical Bore

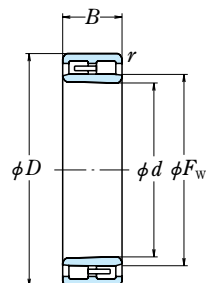

NNU
Tapered Bore

d	Boundary Dimensions (mm)					Basic Load Ratings (kN) (kgf)				Bearing Numbers	
	D	B	r min.	F _W	E _W	C _r	C _{0r}	C _r	C _{0r}	Cylindrical Bore	Tapered Bore (1)
380	520	140	4	—	485	1 880	4 600	191 000	470 000	NN4976	NN4976K
	520	140	4	421	—	1 880	4 600	191 000	470 000	NNU4976	—
	560	135	5	—	513	1 770	3 700	181 000	375 000	NN3076	NN3076K
380	560	180	5	—	513	2 650	6 200	270 000	630 000	NN4076	NN4076K
	560	180	5	433	—	2 650	6 200	270 000	630 000	NNU4076	—
	620	194	5	—	559	2 620	4 950	267 000	505 000	NN3176	NN3176K
	620	194	5	449	—	2 620	4 950	267 000	505 000	NNU3176	—
	620	194	5	—	—	—	—	—	—	—	—
400	500	100	2.1	430	—	905	2 540	92 500	259 000	NNU4880	—
	540	106	4	—	504	1 290	2 890	132 000	295 000	NN3980	—
	540	140	4	—	505	1 940	4 900	198 000	500 000	NN4980	NN4980K
400	540	140	4	446	—	1 790	4 600	182 000	470 000	NNU4980	NNU4980K
	600	148	5	—	548	2 090	4 300	213 000	435 000	NN3080	NN3080K
	600	200	5	456	—	2 840	6 050	290 000	615 000	NNU4080	—
	650	200	6	474	—	2 770	5 400	283 000	555 000	NNU3180	—
	650	200	6	—	—	—	—	—	—	—	—
420	560	106	4	—	522	1 280	2 900	131 000	296 000	NN3984	—
	560	140	4	—	525	2 000	5 150	204 000	525 000	NN4984	NN4984K
	560	140	4	461	—	2 000	5 150	204 000	525 000	NNU4984	—
420	620	150	5	—	568	2 130	4 450	217 000	455 000	NN3084	NN3084K
	620	150	5	478	—	2 130	4 450	217 000	455 000	NNU3084	NNU3084K
	620	200	5	—	571	3 150	7 100	325 000	725 000	NN4084	NN4084K
420	620	200	5	475	—	3 400	7 850	350 000	800 000	NNU4084	—
	700	224	6	501	—	3 550	6 800	360 000	690 000	NNU3184	—
	700	224	6	—	—	—	—	—	—	—	—
440	540	100	2.1	470	—	950	2 790	97 000	284 000	NNU4888	—
	650	157	6	—	596	2 360	4 900	240 000	500 000	NN3088	NN3088K
	650	157	6	500	—	2 360	4 900	240 000	500 000	NNU3088	—
	720	226	6	—	649	3 500	6 800	360 000	695 000	NN3188	NN3188K
460	620	118	4	—	578	1 610	3 700	164 000	380 000	NN3992	NN3992K
	620	160	4	507	—	2 400	6 200	245 000	630 000	NNU4992	NNU4992K
	680	163	6	—	623	2 550	5 350	260 000	545 000	NN3092	NN3092K
480	650	170	5	—	607	2 690	7 000	274 000	715 000	NN4996	NN4996K
	700	165	6	—	643	2 600	5 550	265 000	565 000	NN3096	—
	790	248	7.5	—	708	4 050	8 100	415 000	825 000	NN3196	NN3196K

Note (1) The suffix K represents with tapered bores (taper 1:12).

Remarks Production of double-row cylindrical roller bearings is generally in the high precision classes (Class 5 or better).

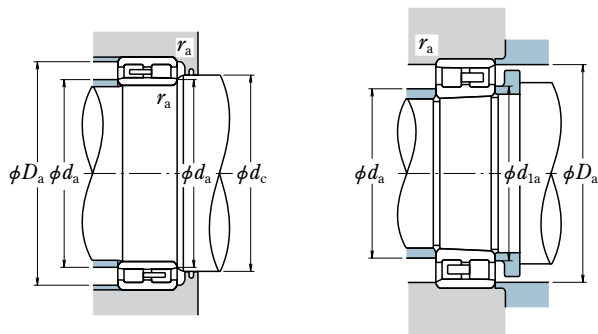

Abutment and Fillet Dimensions (mm)					Mass (kg)
$d_a^{(2)}$	d_{1a}	d_c min.	D_a	r_a max.	approx.
404	416	—	493	3	81.3
404	—	428	493	3	88.8
408	420	—	529	4	113
408	424	—	529	4	142
408	—	440	529	4	153
408	425	—	588	4	224
408	—	456	588	4	228
420	—	437	479	2	45.7
425	—	—	513	3	68.7
425	437	—	513	3	84.1
425	437	453	513	3	93.6
429	441	—	568	4	147
429	—	463	568	4	201
435	—	481	611	5	262
445	—	—	533	3	71.2
445	457	—	533	3	87.9
445	—	468	533	3	97.2
449	462	—	588	4	154
449	462	485	588	4	155
449	466	—	588	4	189
449	—	482	588	4	209
455	—	508	660	5	347
461	—	477	518	2	49.5
476	489	—	611	5	177
476	—	507	611	5	178
476	495	—	680	5	357
486	496	—	591	3	94.5
486	500	514	591	3	140
496	510	—	640	5	202
510	525	—	617	4	164
517	—	—	660	5	211
523	544	—	742	6	447

Note ⁽²⁾ d_a are values for adjusting ring for the NNU type.

DOUBLE-ROW CYLINDRICAL ROLLER BEARINGS

Bore Diameter 500 – 850 mm

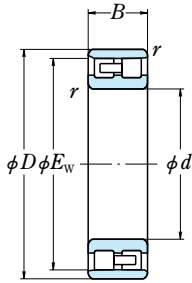

NN
Cylindrical Bore

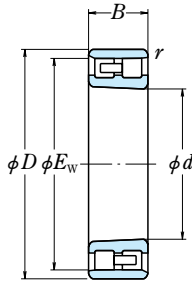

NN
Tapered Bore

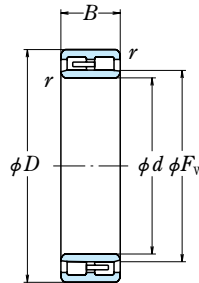

NNU
Cylindrical Bore

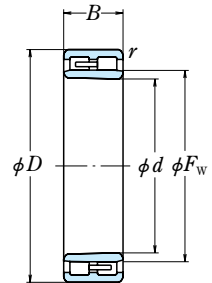

NNU
Tapered Bore

	Boundary Dimensions (mm)					Basic Load Ratings				Bearing Numbers	
	d	D	B	r min.	F_W E_W	C_r (kN)	C_{0r} (kgf)	C_r (kN)	C_{0r} (kgf)	Cylindrical Bore	Tapered Bore ⁽¹⁾
500	670	170	5	551	—	2 720	7 200	278 000	735 000	NNU49/500	—
	720	167	6	—	663	2 580	5 600	264 000	570 000	NN30/500	NN30/500K
	720	167	6	563	—	2 580	5 600	264 000	570 000	NNU30/500	—
530	710	136	5	—	663	2 040	4 900	208 000	495 000	NN39/530	—
	710	180	5	575	—	2 900	7 050	296 000	720 000	NNU49/530	NNU49/530K
	780	185	6	—	715	3 200	6 900	325 000	705 000	NN30/530	NN30/530K
560	750	190	5	617	—	3 250	8 700	330 000	890 000	NNU49/560	—
	820	258	6	—	745	4 100	10 600	420 000	1 080 000	NN40/560	—
	920	280	7.5	650	—	6 850	13 700	700 000	1 400 000	NNU31/560	—
600	800	200	5	659	—	3 850	10 500	390 000	1 070 000	NNU49/600	—
630	780	150	4	676	—	2 290	7 000	234 000	710 000	NNU48/630	—
	850	218	6	—	793	4 200	11 400	425 000	1 160 000	NN49/630	NN49/630K
	850	218	6	704	—	4 000	10 800	410 000	1 100 000	NNU49/630	NNU49/630K
670	900	230	6	—	838	4 150	11 500	420 000	1 170 000	NN49/670	—
710	870	160	4	759	—	2 640	8 350	270 000	850 000	NNU48/710	—
800	1 060	258	6	879	—	5 700	16 500	585 000	1 690 000	NNU49/800	NNU49/800K
850	1 030	180	5	905	—	3 400	11 400	350 000	1 160 000	NNU48/850	—

Note ⁽¹⁾ The suffix K represents with tapered bores (taper 1:12).

Remarks Production of double-row cylindrical roller bearings is generally in the high precision classes (Class 5 or better).

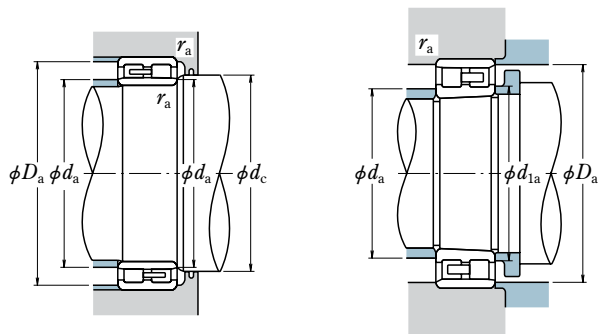

Abutment and Fillet Dimensions (mm)					Mass (kg)
$d_a^{(2)}$	d_{1a}	d_c min.	D_a	r_a max.	approx.
531	—	558	637	4	171
537	551	—	680	5	205
537	—	570	680	5	220
561	—	—	676	4	149
561	574	582	676	4	202
568	583	—	738	5	296
592	—	624	715	4	239
598	—	—	778	5	472
604	—	657	870	6	738
633	—	666	764	4	284
659	—	683	748	3	160
670	688	—	807	5	328
670	688	711	807	5	356
710	—	—	856	5	419
741	—	766	836	3	203
843	865	886	1 013	5	573
888	—	912	989	4	310

Note ⁽²⁾ d_a are values for adjusting ring for the NNU type.



FULL-COMPLEMENT CYLINDRICAL ROLLER BEARINGS

Single-Row	NCF	Bore Diameter 100 – 670mm	B82
Double-Row	NNCF	Bore Diameter 100 – 500mm	B86
	RS-48E4, RS-49E4	Bore Diameter 100 – 560mm	B90
	RSF-48E4, RSF-49E4	Bore Diameter 100 – 560mm	B90
	RS-50, RS-50NR	Bore Diameter 100 – 400mm	B94

Design, Types, and Features

Cageless, full-complement cylindrical roller bearings have the maximum possible number of rollers and can sustain much heavier loads than cylindrical roller bearings of the same size with cages. On the other hand, high-speed capability is inferior to the bearings with cages.

The open-type single- and double-row bearings are mostly used in general industrial applications at low speed and under heavy load, and the shielded-type double-row bearings are often used in crane sheaves.

Table 1 Features of Various Types

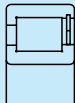
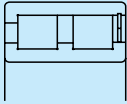
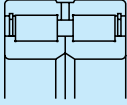
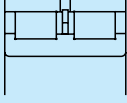
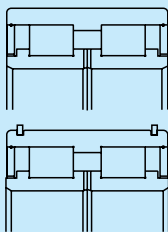
Figure	Type	Design and Features
	NCF	The outer and inner rings and rollers are non-separable since a retaining snap ring is installed at the side opposite the outer ring rib. They can sustain axial loads in only one direction.
	NNCF	NNCF is a double-row version of NCF. They can sustain heavy radial loads.
	RS-48E4 RS-49E4	Double-row outer ring with center rib, two single-row inner rings with ribs. The outer and inner rings and rollers are non-separable since there are two retaining snap rings at the sides of the outer ring. They can sustain an axial load in either direction so they can be used as fixed-end bearings. An oil groove and holes are provided at the center of the outer ring.
	RSF-48E4 RSF-49E4	Double-row outer ring without ribs, double-row inner ring with three ribs. The outer and inner rings and rollers are non-separable since there is a retaining snap ring at the middle of the outer ring. They can be used as free-end bearings. The permissible axial movement is listed in the dimensional tables. An oil groove and holes are provided at the center of the outer ring.
	RS-50 RS-50NR	Both sides shielded, double-row outer ring with center rib, two inner rings with ribs. They can sustain an axial load in either direction. They are prelubricated, but it is possible to replenish the grease through an oil groove and holes in parts mating with the inner rings. If there are snap rings at the outside of the outer ring, this type becomes RS-50NR. They are surface-treated for rust prevention.

Tolerances and Running Accuracy.....Table 2.2 (Pages A16 to A19)

Single-Row
Double-Row

Recommended Fits

Single-Row
Double-Row

Inner Ring Rotation.....Table 3.2 (Page A35)
Table 3.4 (Page A36)

Outer Ring RotationTable 2 below

Table 2 Fits and Internal Clearances for Full-Complement Cylindrical Roller Bearings

Operating Conditions		Fitting between Inner Ring and Shaft	Fitting between Outer Ring and Housing Bore	Recommended Internal Clearance
Outer Ring Rotation	Thin walled housings and heavy loads	g6 or h6	P7	C 3
	Normal to heavy loads	g6 or h6	N7	C 3
	Light or fluctuating loads	g6 or h6	M7	CN

Internal clearance of RS and RSF type bearings is shown in Table 3.

Single-Row
Double-Row

Table 3 Internal Clearances
Units:µm

Nominal Bore Diameter <i>d</i> (mm)		Internal Clearance			
		CN		C3	
over	incl	min	max	min	max
80	100	30	80	65	115
100	120	35	90	80	135
120	140	40	105	90	155
140	160	50	115	100	165
160	180	60	125	110	175
180	200	65	135	125	195
200	225	75	150	140	215
225	250	90	165	155	230
250	280	100	180	175	255
280	315	110	195	195	280
315	355	125	215	215	305
355	400	140	235	245	340
400	450	155	275	270	390
450	500	180	300	300	420

Internal clearance of NCF and NNCF type bearings is shown in Table 3.11 on page A41.

Permissible Misalignment

The permissible misalignment of full-complement single-row cylindrical roller bearings is generally 0.0006 radian (2') under normal load.
For double-row bearings, nearly on misalignment is allowed.

FULL-COMPLEMENT CYLINDRICAL ROLLER BEARINGS

NCF Type, Single-Row

Bore Diameter 100 – 280 mm

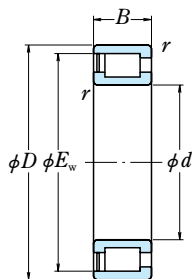

d	Boundary Dimensions (mm)				Basic Load Ratings (kN)		Bearing Numbers
	D	B	r min.	E_w	C_r	C_{0r}	
100	140	24	1.1	130.5	132	209	NCF2920V
	150	37	1.5	139.7	209	310	NCF3020V
110	150	24	1.1	141	138	229	NCF2922V
	170	45	2	156.3	278	405	NCF3022V
120	165	27	1.1	154	177	305	NCF2924V
	180	46	2	167.58	293	440	NCF3024V
130	180	30	1.5	166.5	210	370	NCF2926V
	200	52	2	183.81	415	615	NCF3026V
140	190	30	1.5	179.4	227	395	NCF2928V
	210	53	2	197.82	435	680	NCF3028V
150	210	36	2	195	289	505	NCF2930V
	225	56	2.1	206.82	460	710	NCF3030V
160	220	36	2	207	310	535	NCF2932V
	240	60	2.1	224.8	520	810	NCF3032V
170	215	22	1.5	203.5	149	272	NCF1834V
	230	36	2	218	320	570	NCF2934V
	260	67	2.1	242.87	675	1 070	NCF3034V
180	225	22	1.5	215	154	290	NCF1836V
	250	42	2	231.5	390	695	NCF2936V
	280	74	2.1	260.3	785	1 260	NCF3036V
190	240	24	1.5	228.7	178	335	NCF1838V
	260	42	2	243.6	435	785	NCF2938V
	290	75	2.1	269.9	805	1 320	NCF3038V
200	250	24	1.5	237	182	350	NCF1840V
	280	48	2.1	261	530	955	NCF2940V
	310	82	2.1	287.8	910	1 510	NCF3040V
220	270	24	2	257.7	191	385	NCF1844V
	300	48	2.1	282	555	1 050	NCF2944V
	340	90	3	312.3	1 100	1 820	NCF3044V
240	300	28	2	283	236	470	NCF1848V
	320	48	2.1	303	580	1 140	NCF2948V
	360	92	3	335.25	1 160	1 990	NCF3048V
260	320	28	2	307	247	510	NCF1852V
	360	60	2.1	333.2	750	1 460	NCF2952V
	400	104	4	376.1	1 570	2 600	NCF3052V
280	350	33	2.5	333.9	330	675	NCF1856V
	380	60	2.1	358.8	880	1 740	NCF2956V
	420	106	4	390.5	1 610	2 730	NCF3056V

Remarks Full-complement cylindrical roller bearings are designed for specific applications, when using them, please contact NSK.

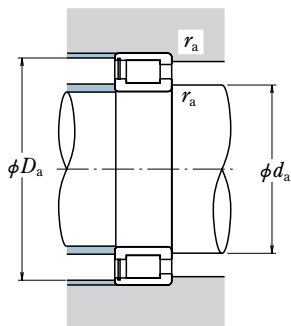

Abutment and Fillet Dimensions (mm)			Mass (kg)
d_a	D_a	r_a max.	approx.
109	131	1	1.0
111	140	1.5	2.1
119	142	1	1.1
122	157	2	3.3
130	155	1	1.7
132	168	2	3.6
141	168	1.5	2.2
142	187	2	5.6
151	180	1.5	2.3
152	198	2	5.9
163	196	2	3.7
165	209	2	7.1
173	208	2	3.8
175	225	2	8.6
182	204	1.5	1.8
183	219	2	4.1
185	244	2	11.9
192	216	1.5	1.8
193	236	2	6.0
195	263	2	15.8
202	229	1.5	2.4
203	245	2	6.5
206	273	2	16.7
213	238	1.5	2.5
216	263	2	8.9
216	293	2	21.4
234	258	2	2.7
236	283	2	9.6
238	320	2.5	28.2
254	285	2	4.2
257	304	2	10.4
259	340	2.5	31.2
275	308	2	4.5
277	342	2	18.1
282	377	3	45.3
298	334	2	6.8
297	361	2	19.5
302	395	3	49

FULL-COMPLEMENT CYLINDRICAL ROLLER BEARINGS

NCF Type, Single-Row

Bore Diameter 300 – 800 mm

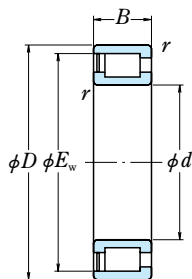

Boundary Dimensions (mm)					Basic Load Ratings (kN)		Bearing Numbers
d	D	B	r min.	E_w	C_r	C_{0r}	
300	380	38	2.5	359	445	870	NCF1860V
	420	72	3	389.6	1 120	2 200	NCF2960V
	460	118	4	431.7	1 980	3 500	NCF3060V
320	400	38	2.1	380	460	925	NCF1864V
	440	72	3	410	1 150	2 340	NCF2964V
	480	121	4	449.6	2 170	3 900	NCF3064V
340	420	38	2.1	401	475	985	NCF1868V
	460	72	3	430.3	1 190	2 470	NCF2968V
	520	133	5	485.8	2 480	4 350	NCF3068V
360	440	38	2.5	422	490	1 040	NCF1872V
	480	72	3	450.7	1 220	2 610	NCF2972V
	540	134	5	503.6	2 550	4 600	NCF3072V
380	480	46	2.5	452.8	575	1 230	NCF1876V
	520	82	4	486.7	1 600	3 350	NCF2976V
	560	135	5	521.4	2 610	4 800	NCF3076V
400	500	46	2.5	475.7	590	1 300	NCF1880V
	540	82	4	511	1 650	3 550	NCF2980V
	600	148	5	558.7	3 050	5 750	NCF3080AV
420	520	46	2.1	491	600	1 340	NCF1884V
	560	82	4	523.2	1 680	3 650	NCF2984V
	620	150	5	577.7	3 000	5 650	NCF3084V
440	540	46	2.1	514	615	1 410	NCF1888V
	600	95	4	562	2 070	4 300	NCF2988V
	660	150	5	619.7	3 000	5 650	NCF3088V
460	580	56	3	552.7	920	1 950	NCF1892V
	620	95	4	576.5	2 100	4 450	NCF2992V
	680	150	5	634.2	3 000	5 650	NCF3092V
480	600	56	3	573	940	2 040	NCF1896V
	650	100	5	615	2 380	5 100	NCF2996V
	710	150	5	672.7	3 000	5 650	NCF3096V
500	620	56	3	593.5	960	2 120	NCF18/500V
	670	100	5	630.2	2 420	5 250	NCF29/500V
	730	150	5	687.7	3 000	5 650	NCF30/500V
530	650	56	3	624	990	2 240	NCF18/530V
	680	56	3	654.7	1 020	2 360	NCF18/560V
	820	195	6	770	5 600	11 300	NCF30/560V
600	730	60	3	695.5	1 140	2 680	NCF18/600V
	800	118	5	752	3 050	7 300	NCF29/600V
	860	150	5	810	3 000	5 650	NCF30/600V
630	780	69	4	742	1 470	3 400	NCF18/630V
670	820	69	4	780	1 520	3 550	NCF18/670V
710	870	74	4	832.5	1 650	3 900	NCF18/710V
750	920	78	5	882.3	1 930	4 600	NCF18/750V
800	980	82	5	936	2 110	5 100	NCF18/800V

Remarks Full-complement cylindrical roller bearings are designed for specific applications, when using them, please contact NSK.

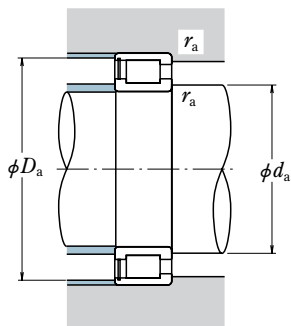

Abutment and Fillet Dimensions (mm)			Mass (kg)
d_a	D_a	r_a max.	approx.
319	360	2	9.7
320	398	2.5	30.7
323	435	3	67.6
338	381	2	10.3
340	418	2.5	33
343	454	3	73
359	402	2	10.7
361	438	2.5	34.1
368	490	4	97
380	423	2	11.5
381	457	2.5	36
388	509	4	102
400	458	2	18.6
404	493	3	52
408	529	4	108
421	478	2	19.5
425	513	3	53.4
429	568	4	139
440	498	2	20.5
445	533	3	55.7
449	588	4	147
461	518	2	21.3
466	572	3	78.2
483	555	2.5	32.5
486	591	3	81.2
503	575	2.5	33.8
510	617	4	95.1
524	594	2.5	35
531	637	4	98.4
554	625	2.5	36.9
585	655	2.5	39.3
598	778	5	332.5
626	702	2.5	48.9
633	764	4	164.9
659	748	3	68.8
700	787	3	72.7
741	836	3	87.6
786	883	4	103.3
837	940	4	123.1

FULL-COMPLEMENT CYLINDRICAL ROLLER BEARINGS

NNCF Type, Double-Row

Bore Diameter 100 – 260 mm

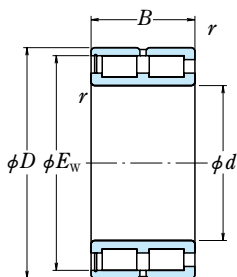

Boundary Dimensions (mm)					Basic Load Ratings (kN)		Bearing Numbers
d	D	B	r min.	E_w	C_r	C_{0r}	
100	140	40	1.1	129.8	194	400	NNCF4920V
	150	67	1.5	139.7	360	615	NNCF5020V
110	150	40	1.1	138.4	202	430	NNCF4922V
	170	80	2	156.3	490	840	NNCF5022V
120	165	45	1.1	153.8	226	480	NNCF4924V
	180	80	2	167.58	500	885	NNCF5024V
130	180	50	1.5	165.7	262	555	NNCF4926V
	200	95	2	183.81	710	1 230	NNCF5026V
140	190	50	1.5	176.2	272	595	NNCF4928V
	210	95	2	197.82	750	1 360	NNCF5028V
150	210	60	2	191.6	390	865	NNCF4930V
	225	100	2.1	206.82	785	1 420	NNCF5030V
160	220	60	2	204.1	410	930	NNCF4932V
	240	109	2.1	224.8	895	1 620	NNCF5032V
170	230	60	2	212.4	415	975	NNCF4934V
	260	122	2.1	242.87	1 160	2 140	NNCF5034V
180	250	69	2	230.5	550	1 230	NNCF4936V
	280	136	2.1	260.3	1 340	2 510	NNCF5036V
190	260	69	2	240.7	565	1 290	NNCF4938V
	290	136	2.1	269.9	1 380	2 630	NNCF5038V
200	250	50	1.5	235.9	320	825	NNCF4840V
	280	80	2.1	259.5	665	1 500	NNCF4940V
	310	150	2.1	287.75	1 560	3 000	NNCF5040V
220	270	50	1.5	256.9	340	905	NNCF4844V
	300	80	2.1	277	695	1 620	NNCF4944V
	340	160	3	312.3	1 890	3 650	NNCF5044V
240	300	60	2	282.6	495	1 340	NNCF4848V
	320	80	2.1	300	725	1 770	NNCF4948V
	360	160	3	335.25	1 990	4 000	NNCF5048V
260	320	60	2	303.6	515	1 450	NNCF4852V
	360	100	2.1	331.5	1 050	2 530	NNCF4952V
	400	190	4	376.1	2 690	5 200	NNCF5052V

Remarks Full-complement cylindrical roller bearings are designed for specific applications, when using them, please contact NSK.

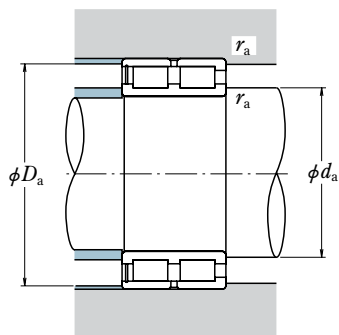

Abutment and Fillet Dimensions (mm)			Mass (kg)
d_a	D_a	r_a max.	approx.
109	130	1	2.0
111	140	1.5	3.8
119	140	1	2.1
122	157	2	6.1
130	155	1	2.9
132	168	2	6.5
141	168	1.5	3.9
142	187	2	10.3
151	178	1.5	4.2
152	198	2	10.8
163	196	2	6.6
165	209	2	13
173	206	2	7.0
175	225	2	15.8
183	216	2	7.3
185	244	2	22.1
193	236	2	10.7
195	263	2	29.4
203	245	2	11.1
206	273	2	30.8
213	237	1.5	5.9
216	263	2	15.7
216	293	2	39.7
233	257	1.5	6.4
236	283	2	17
238	320	2.5	50.7
254	285	2	10.3
257	302	2	18.4
259	340	2.5	54.3
275	304	2	11
277	342	2	32
282	377	3	82.7

FULL-COMPLEMENT CYLINDRICAL ROLLER BEARINGS

NNCF Type, Double-Row

Bore Diameter 280 – 500 mm

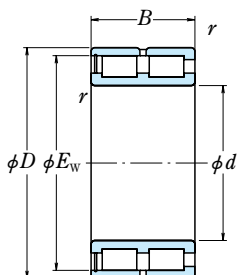

<i>d</i>	Boundary Dimensions (mm)				Basic Load Ratings (kN)		Bearing Numbers
	<i>D</i>	<i>B</i>	<i>r</i> min.	<i>E_w</i>	<i>C_r</i>	<i>C_{0r}</i>	
280	350	69	2	332.5	685	1 860	NNCF4856V
	380	100	2.1	352.5	1 090	2 720	NNCF4956V
	420	190	4	390.5	2 770	5 450	NNCF5056V
300	380	80	2.1	357.2	805	2 160	NNCF4860V
	420	118	3	386.5	1 580	3 800	NNCF4960V
	460	218	4	431.7	3 400	7 000	NNCF5060V
320	400	80	2.1	380.2	835	2 310	NNCF4864V
	440	118	3	404.5	1 620	4 000	NNCF4964V
	480	218	4	446.9	3 500	7 350	NNCF5064V
340	420	80	2.1	397.4	855	2 430	NNCF4868V
	460	118	3	431	1 690	4 300	NNCF4968V
	520	243	5	485.8	4 250	8 750	NNCF5068V
360	440	80	2.1	420.4	885	2 580	NNCF4872V
	480	118	3	449	1 730	4 500	NNCF4972V
	540	243	5	503.6	4 350	9 150	NNCF5072V
380	480	100	2.1	450.6	1 260	3 600	NNCF4876V
	520	140	4	482.5	2 180	5 650	NNCF4976V
	560	243	5	521.4	4 500	9 600	NNCF5076V
400	500	100	2.1	471.7	1 290	3 750	NNCF4880V
	540	140	4	503	2 240	5 900	NNCF4980V
	600	272	5	558.7	5 050	10 900	NNCF5080V
420	520	100	2.1	492	1 320	3 950	NNCF4884V
	560	140	4	523	2 290	6 200	NNCF4984V
	620	272	5	577.7	5 150	11 300	NNCF5084V
440	540	100	2.1	513	1 350	4 150	NNCF4888V
	600	160	4	560.5	3 000	7 850	NNCF4988V
460	580	118	3	549.2	1 730	5 150	NNCF4892V
	620	160	4	573	3 050	8 050	NNCF4992V
480	600	118	3	565.8	1 760	5 300	NNCF4896V
	650	170	5	603	3 350	8 900	NNCF4996V
500	620	118	3	590.7	1 810	5 600	NNCF48/500V
	670	170	5	629	3 400	9 350	NNCF49/500V

Remarks Full-complement cylindrical roller bearings are designed for specific applications, when using them, please contact NSK.

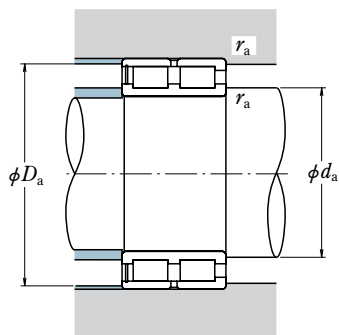

Abutment and Fillet Dimensions (mm)			Mass (kg)
d_a	D_a	r_a max.	approx.
295	334	2	16
297	361	2	34
302	395	3	87.7
318	361	2	23
320	398	2.5	52
323	435	3	125
338	381	2	24.3
340	418	2.5	55
343	454	3	131
359	400	2	25.6
361	438	2.5	58
368	490	4	177
379	421	2	27
381	457	2.5	61
388	509	4	186
399	459	2	45.5
404	493	3	90.5
408	529	4	194
420	479	2	47.5
425	513	3	94.5
429	568	4	256
440	498	2	49.5
445	533	3	98.5
449	588	4	267
461	518	2	51.5
466	572	3	136
483	555	2.5	77.5
486	591	3	142
503	575	2.5	80.5
510	617	4	167
524	594	2.5	83.5
531	637	4	173

FULL-COMPLEMENT CYLINDRICAL ROLLER BEARINGS

RS-48 · RS-49 Types, Double-Row

RSF-48 · RSF-49 Types, Double-Row

Bore Diameter 100 – 280 mm

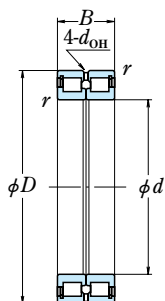

Fixed-End Bearing
RS

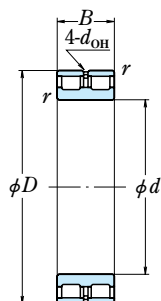

Free-End Bearing
RSF

Boundary Dimensions (mm)				Basic Load Ratings (kN)		Bearing Numbers ⁽¹⁾	
<i>d</i>	<i>D</i>	<i>B</i>	<i>r</i> min.	<i>C_r</i>	<i>C_{0r}</i>	Fixed-End Bearing	Free-End Bearing
100	125	25	1	87.5	189	RS-4820E4	RSF-4820E4
	140	40	1.1	194	400	RS-4920E4	RSF-4920E4
105	130	25	1	89.0	196	RS-4821E4	RSF-4821E4
	145	40	1.1	199	420	RS-4921E4	RSF-4921E4
110	140	30	1	114	260	RS-4822E4	RSF-4822E4
	150	40	1.1	202	430	RS-4922E4	RSF-4922E4
120	150	30	1	119	283	RS-4824E4	RSF-4824E4
	165	45	1.1	226	480	RS-4924E4	RSF-4924E4
130	165	35	1.1	162	390	RS-4826E4	RSF-4826E4
	180	50	1.5	262	555	RS-4926E4	RSF-4926E4
140	175	35	1.1	167	415	RS-4828E4	RSF-4828E4
	190	50	1.5	272	595	RS-4928E4	RSF-4928E4
150	190	40	1.1	235	575	RS-4830E4	RSF-4830E4
	210	60	2	390	865	RS-4930E4	RSF-4930E4
160	200	40	1.1	243	615	RS-4832E4	RSF-4832E4
	220	60	2	410	930	RS-4932E4	RSF-4932E4
170	215	45	1.1	265	650	RS-4834E4	RSF-4834E4
	230	60	2	415	975	RS-4934E4	RSF-4934E4
180	225	45	1.1	272	685	RS-4836E4	RSF-4836E4
	250	69	2	495	1 130	RS-4936E4	RSF-4936E4
190	240	50	1.5	315	785	RS-4838E4	RSF-4838E4
	260	69	2	510	1 180	RS-4938E4	RSF-4938E4
200	250	50	1.5	320	825	RS-4840E4	RSF-4840E4
	280	80	2.1	665	1 500	RS-4940E4	RSF-4940E4
220	270	50	1.5	340	905	RS-4844E4	RSF-4844E4
	300	80	2.1	695	1 620	RS-4944E4	RSF-4944E4
240	300	60	2	495	1 340	RS-4848E4	RSF-4848E4
	320	80	2.1	725	1 770	RS-4948E4	RSF-4948E4
260	320	60	2	515	1 450	RS-4852E4	RSF-4852E4
	360	100	2.1	1 050	2 530	RS-4952E4	RSF-4952E4
280	350	69	2	610	1 690	RS-4856E4	RSF-4856E4
	380	100	2.1	1 090	2 720	RS-4956E4	RSF-4956E4

Remarks Full-complement cylindrical roller bearings are designed for specific applications, when using them, please contact NSK.

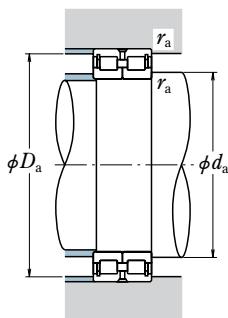

Dimensions (mm)		Abutment and Fillet Dimensions (mm)			Mass (kg)
$d_{OH}^{(2)}$	Axial Disp. (°)	d_a min.	D_a max.	r_a max.	approx.
3	1.5	105	120	1	0.7
3	2	106.5	133.5	1	1.9
3	1.5	110	125	1	0.7
3	2	111.5	138.5	1	2.0
3	2	115	135	1	1.0
3	2	116.5	143.5	1	2.1
3	2	125	145	1	1.2
4	3	126.5	158.5	1	2.9
3	2	136.5	158.5	1	1.9
5	3.5	138	172	1.5	3.9
3	2	146.5	168.5	1	2.0
5	3.5	148	182	1.5	4.2
3	2	156.5	183.5	1	2.8
5	3.5	159	201	2	6.6
3	2	166.5	193.5	1	3.0
5	3.5	169	211	2	7.0
4	3	176.5	208.5	1	4.1
4	3.5	179	221	2	7.3
4	3	186.5	218.5	1	4.3
6	4.5	189	241	2	10.7
5	3.5	198	232	1.5	5.6
6	4.5	199	251	2	11.1
5	3.5	208	242	1.5	5.9
7	5	211	269	2	15.7
5	3.5	228	262	1.5	6.4
7	5	231	289	2	17
5	3.5	249	291	2	10.3
7	5	251	309	2	18.4
5	3.5	269	311	2	11
8	6	271	349	2	32
6	4.5	289	341	2	16
8	6	291	369	2	34

Notes ⁽¹⁾ The suffix E4 indicates that the outer ring is provided with oil holes and oil groove.

⁽²⁾ d_{OH} represents the oil hole diameter in the outer ring.

⁽³⁾ Permissible axial displacement for free-end bearings.

FULL-COMPLEMENT CYLINDRICAL ROLLER BEARINGS

RS-48 · RS-49 Types, Double-Row

RSF-48 · RSF-49 Types, Double-Row

Bore Diameter 300 – 560 mm

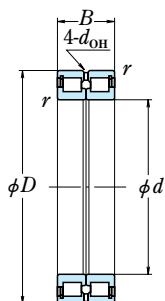

Fixed-End Bearing
RS

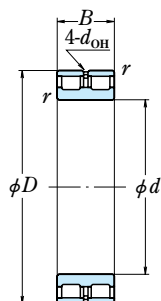

Free-End Bearing
RSF

Boundary Dimensions (mm)				Basic Load Ratings (kN)		Bearing Numbers ⁽¹⁾	
<i>d</i>	<i>D</i>	<i>B</i>	<i>r</i> min.	<i>C_r</i>	<i>C_{0r}</i>	Fixed-End Bearing	Free-End Bearing
300	380	80	2.1	805	2 160	RS-4860E4	RSF-4860E4
	420	118	3	1 460	3 400	RS-4960E4	RSF-4960E4
320	400	80	2.1	835	2 310	RS-4864E4	RSF-4864E4
	440	118	3	1 500	3 600	RS-4964E4	RSF-4964E4
340	420	80	2.1	855	2 430	RS-4868E4	RSF-4868E4
	460	118	3	1 560	3 900	RS-4968E4	RSF-4968E4
360	440	80	2.1	885	2 580	RS-4872E4	RSF-4872E4
	480	118	3	1 600	4 050	RS-4972E4	RSF-4972E4
380	480	100	2.1	1 260	3 600	RS-4876E4	RSF-4876E4
	520	140	4	2 040	5 200	RS-4976E4	RSF-4976E4
400	500	100	2.1	1 290	3 750	RS-4880E4	RSF-4880E4
	540	140	4	2 100	5 450	RS-4980E4	RSF-4980E4
420	520	100	2.1	1 320	3 950	RS-4884E4	RSF-4884E4
	560	140	4	2 150	5 700	RS-4984E4	RSF-4984E4
440	540	100	2.1	1 350	4 150	RS-4888E4	RSF-4888E4
	600	160	4	2 840	7 350	RS-4988E4	RSF-4988E4
460	580	118	3	1 730	5 150	RS-4892E4	RSF-4892E4
	620	160	4	2 870	7 500	RS-4992E4	RSF-4992E4
480	600	118	3	1 760	5 300	RS-4896E4	RSF-4896E4
	650	170	5	3 200	8 500	RS-4996E4	RSF-4996E4
500	620	118	3	1 810	5 600	RS-48/500E4	RSF-48/500E4
	670	170	5	3 300	8 900	RS-49/500E4	RSF-49/500E4
530	710	180	5	3 400	9 200	RS-49/530E4	RSF-49/530E4
	750	190	5	3 800	10 100	RS-49/560E4	RSF-49/560E4

Remarks Full-complement cylindrical roller bearings are designed for specific applications, when using them, please contact NSK.

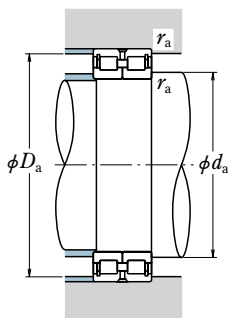

Dimensions (mm)		Abutment and Fillet Dimensions (mm)			Mass (kg)
$d_{OH}^{(2)}$	Axial Disp. $^{(3)}$	d_a min.	D_a max.	r_a max.	approx.
6	5	311	369	2	23
9	7	313	407	2.5	52
6	5	331	389	2	24.3
9	7	333	427	2.5	55
6	5	351	409	2	25.6
9	7	353	447	2.5	58
6	5	371	429	2	27
9	7	373	467	2.5	61
8	6	391	469	2	45.5
11	8	396	504	3	90.5
8	6	411	489	2	47.5
11	8	416	524	3	94.5
8	6	431	509	2	49.5
11	8	436	544	3	98.5
8	6	451	529	2	51.5
11	8	456	584	3	136
9	7	473	567	2.5	77.5
11	8	476	604	3	142
9	7	493	587	2.5	80.5
12	9	500	630	4	167
9	7	513	607	2.5	83.5
12	9	520	650	4	173
12	11	550	690	4	206
12	11	580	730	4	231

Notes ⁽¹⁾ The suffix E4 indicates that the outer ring is provided with oil holes and oil groove.

⁽²⁾ d_{OH} represents the oil hole diameter in the outer ring.

⁽³⁾ Permissible axial displacement for free-end bearings.

FULL-COMPLEMENT CYLINDRICAL ROLLER BEARINGS

RS-50 Type (Prelubricated), Double-Row

Bore Diameter 100 – 400 mm

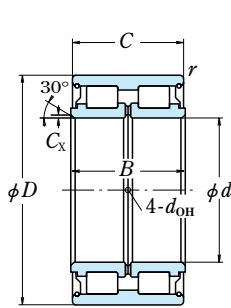

Without Locating Ring

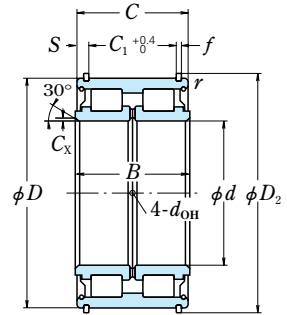

With Locating Ring

Boundary Dimensions (mm)						Basic Load Ratings (kN)		Bearing Numbers	
<i>d</i>	<i>D</i>	<i>B</i>	<i>C</i>	<i>C_x</i> ⁽¹⁾ min.	<i>r</i> min.	<i>C_r</i>	<i>C_{0r}</i>	Without Locating Ring	With Locating Ring
100	150	67	66	1	0.6	320	585	RS-5020	RS-5020NR
110	170	80	79	1.1	1	385	695	RS-5022	RS-5022NR
120	180	80	79	1.1	1	400	750	RS-5024	RS-5024NR
130	200	95	94	1.1	1	535	1 000	RS-5026	RS-5026NR
140	210	95	94	1.1	1	550	1 040	RS-5028	RS-5028NR
150	225	100	99	1.3	1	620	1 210	RS-5030	RS-5030NR
160	240	109	108	1.3	1.1	695	1 370	RS-5032	RS-5032NR
170	260	122	121	1.3	1.1	860	1 680	RS-5034	RS-5034NR
180	280	136	135	1.3	1.1	980	1 910	RS-5036	RS-5036NR
190	290	136	135	1.3	1.1	1 120	2 230	RS-5038	RS-5038NR
200	310	150	149	1.3	1.1	1 310	2 650	RS-5040	RS-5040NR
220	340	160	159	1.5	1.1	1 510	3 100	RS-5044	RS-5044NR
240	360	160	159	1.5	1.1	1 570	3 350	RS-5048	RS-5048NR
260	400	190	189	2	1.5	2 130	4 500	RS-5052	RS-5052NR
280	420	190	189	2	1.5	2 170	4 700	RS-5056	RS-5056NR
300	460	218	216	2	1.5	2 670	5 850	RS-5060	RS-5060NR
320	480	218	216	2	1.5	2 720	6 100	RS-5064	RS-5064NR
340	520	243	241	2.1	2	3 350	7 550	RS-5068	—
360	540	243	241	2.1	2	3 450	7 850	RS-5072	—
380	560	243	241	2.1	2	3 550	8 400	RS-5076	—
400	600	272	270	2.1	2	4 250	9 950	RS-5080	—

Note (1) Chamfer dimension of inner ring in radial direction.

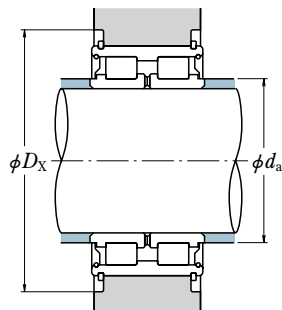

Locating Ring Dimensions (mm)				Oil Holes (mm)	Abutment and Fillet Dimensions (mm)		Mass (kg)
C_1	S	D_2	f	d_{OH}	d_a min.	D_x min.	approx.
54	6	155.4	2.5	4	106	163.5	4.05
65	7	175.4	2.5	5	116.5	183.5	6.1
65	7	188	3	5	126.5	197	7.0
77	8.5	207	3	5	136.5	217	10.6
77	8.5	217	3	5	146.5	227	11.3
81	9	232	3	6	157	242	13.7
89	9.5	247	3	6	167	257	16.8
99	11	270	4	6	177	285	22.2
110	12.5	294	5	6	187	318	30
110	12.5	304	5	6	197	328	32
120	14.5	324	5	6	207	352	41
130	14.5	356	6	7	228.5	382	53
130	14.5	376	6	7	248.5	402	57
154	17.5	416	7	8	270	444	86
154	17.5	436	7	8	290	472	92
178	19	476	7	8	310	512	130
176	20	500	8	8	330	536	135
—	—	—	—	10	352	—	185
—	—	—	—	10	372	—	192
—	—	—	—	10	392	—	196
—	—	—	—	10	412	—	280

- Remarks**
1. Good quality grease is prepacked in bearings.
 2. Grease can be supplied through oil holes in the inner rings.
 3. Full-complement cylindrical roller bearings are designed for specific applications, when using them, please contact NSK.



TAPERED ROLLER BEARINGS

Metric Design Single-Row Tapered Roller Bearings

Bore Diameter 100 – 1 900mm B102

Inch Design Single-Row Tapered Roller Bearings

Bore Diameter 100.000 – 1 270.000mm B114

The index for inch design tapered roller bearings is in an appendix (Page C52~C61).

Double-Cup Type Tapered Roller Bearings

KBE (TDO) Bore Diameter 100 – 2 000mm B182
 KDE (TDO) Bore Diameter 100 – 1 450mm B246
 KF (TNA) Bore Diameter 101.600 – 406.400mm B252

Double-Cone Type Tapered Roller Bearings

KH (TDI) Bore Diameter 100 – 1 290mm B262
 KDH (TDI) Bore Diameter 100 – 540mm B282

Design, Types, and Features

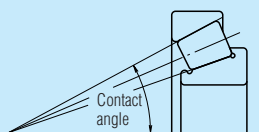

Tapered roller bearings are designed so the apices of the cones formed by the raceways of the cone and cup and the conical rollers all coincide at one point on the axis of the bearing. When a radial load is imposed, an axial force component occurs; therefore, it is necessary to use two bearings in opposition or some other multiple arrangement.

Among the metric design tapered roller bearings with high load capacity (HR series), some bearings have the basic number suffixed by J to conform to the specifications of ISO for the cup back face raceway diameter, cup width, and contact angle. Therefore, the cone assembly and cup of bearings with the same basic number suffixed by J are internationally interchangeable.

For the cone assemblies and cups of inch design tapered roller bearings, except four-row bearings, the bearing numbers are approximately formulated as follows:

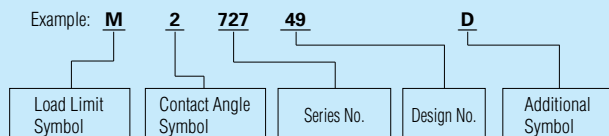

For tapered roller bearings, besides single-row bearings, there are also various combinations of bearings as listed in Table 1.

The cages of tapered roller bearings are either pressed steel or pin type.

Regarding four-row tapered roller bearings for roll necks, refer to page B344.

Table 1 Design and Features of Combinations of Tapered Roller Bearings

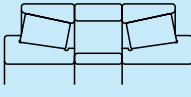
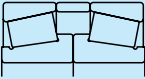
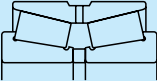
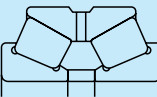
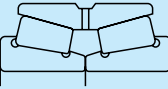
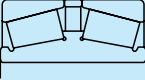
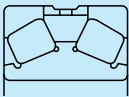
Figure	Arrangement	Examples of Bearing No.	Features
	Back-to-back DB	HR32220JDB+KLR20	Two standard bearings are combined. The bearing internal clearances are adjusted by cone spacers or cup spacers. The cones and cups and spacers are marked with serial numbers and matching symbols. Components with the same serial number can be assembled referring to the matching symbols.
	Face-to-face DF	HR32220JDF+KR	
	KBE(TDO)	100KBE31+L	<p>This type of bearing consists of a double cup and two cone assemblies and a cone spacer. The bearing internal clearance has already been set using the cone spacer, and parts must be combined according to the serial number and matching symbol. The double cup has an oil groove and holes.</p> <p>The KBE type can carry both radial and axial loads, so it can be used as a fixed-end bearing. This is also used frequently on the free end by relieving the shaft elongation/contraction between the cup and housing.</p> <p>This type is basically the same as the back-to-back combination (DB combination) with two single-row tapered roller bearings coupled using cone and cup spacers, but is easier to handle because of fewer parts.</p> <p>This type of bearing is recommended where rigidity is required and strong moments exist.</p>
	KDE(TDO)	100KDE1801+L	<p>This type of bearing is equivalent to the KBE type but with a steeper contact angle.</p> <p>This is used when the axial load is larger than the radial load. The bearing internal clearance has already been set using a cone spacer. The bearing must be assembled according to the serial number and matching symbols.</p>
	KF(TNA)	100KF1701	<p>This type of bearing has one double cup and two cone assemblies. The two cones are in contact face-to-face and there is no cone spacer.</p> <p>Since the bearing internal clearance has already been set, the various parts must be assembled by observing the serial number and matching symbols.</p>
	KH(TDI)	110KH31+K	<p>This type of bearing consists of a double cone assembly and two cups and a cup spacer. Since the bearing internal clearance has already been set using the cup spacer, the parts must be combined according to the serial number and matching symbols. The cup spacer has an oil groove and holes. Since the depth of the oil groove is limited, it is desirable to also provide an oil groove inside the housing.</p>
	KDH(TDI)	100KDH2101+K	<p>This type of bearing is a double-row tapered roller bearing with the rows facing inward but the contact angle is steeper than in the KH type. This consists of a double cone assembly, two cups, and a cup spacer. This is recommended when the axial load is larger than the radial load or an axial load only exists.</p> <p>In certain cases, a spring is provided between the housing shoulder and cup end face for preloading (without using a cup spacer).</p>

Tolerances and Running Accuracy

Metric Design Tapered Roller Bearings..... Table 2.3 (Pages A20 to A23)
 Inch Design Tapered Roller Bearings..... Table 2.4 (Pages A24 to A25)

Inch design tapered roller bearings of J-line (in the bearing tables, bearings preceded by ▲) conform to the following tables. Symbols in the tables are described on page A15. Please contact **NSK** for details.

Table 2 Tolerances for Cones (Class K)

Units : μm

Nominal Bore Diameter d (mm)		Δd_{mp}		V_{dp}	V_{dmp}	K_{ia}
over	incl	high	low	max.	max.	max.
80	120	0	- 20	20	15	30
120	180	0	- 25	25	19	35
180	250	0	- 30	30	23	50
250	315	0	- 35	35	26	60
315	400	0	- 40	40	30	70

Table 3 Tolerances for Cups (Class K)

Units : μm

Nominal Outside Diameter D (mm)		ΔD_{mp}		V_{Dp}	V_{Dmp}	K_{ea}
over	incl	high	low	max.	max.	max.
80	120	0	- 18	18	14	35
120	150	0	- 20	20	15	40
150	180	0	- 25	25	19	45
180	250	0	- 30	30	23	50
250	315	0	- 35	35	26	60
315	400	0	- 40	40	30	70
400	500	0	- 45	45	34	80

Table 4 Tolerances for Effective Width of Cone Assemblies and Cups and Bearing Width (Class K)

Units : μm

Nominal Bore Diameter d (mm)		Cone Assembly Effective Width Deviation ΔT_{1S}		Cup Effective Width Deviation ΔT_{2S}		Bearing Width Deviation ΔT_S	
over	incl	high	low	high	low	high	low
80	120	+ 100	- 100	+ 100	- 100	+ 200	- 200
120	315	+ 150	- 150	+ 200	- 100	+ 350	- 250
315	400	+ 200	- 200	+ 200	- 200	+ 400	- 400

Recommended Fits

Metric Design Tapered Roller BearingsTable 3.2 (Page A35)
 Table 3.4 (Page A36)

Inch Design Tapered Roller BearingsTable 3.6 (Page A37)
 Table 3.7 (Page A38)

Internal ClearancesTable 3.13 (Page A43)

**Metric Design Tapered Roller Bearings
 (Matched and Double-Row)**

**Inch Design Tapered Roller Bearings
 (Matched and Double-Row)**

Dimensions Related to Mounting

The abutment and fillet dimensions for tapered roller bearings and listed in the bearing tables. Since the cages protrude from the ring face of tapered roller bearings, please use care when designing shafts and housings.

When heavy axial loads are imposed, the shaft shoulder dimensions and strength must be sufficient to support the cone rib.

Permissible Misalignment

The permissible misalignment angle for single-row tapered roller bearings is approximately 0.0009 radian (3').

Precautions for Use of Tapered Roller Bearings

1. If the load of tapered roller bearings becomes too small, or if the ratio of the axial and radial loads for matched bearings exceeds 'e' (e is listed in the bearing tables) during operation, slippage between the rollers and raceways occurs, which may result in smearing. Especially with large bearings since the weight of the rollers and cage is high. If such load conditions are expected, please consult with **NSK** for selection of the bearings.
2. Confirm Abutment and Fillet Dimensions D_a and D_b at the time of the HR series adoption.

SINGLE-ROW TAPERED ROLLER BEARINGS

Bore Diameter 100 – 130 mm

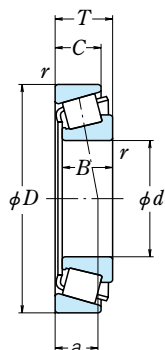

<i>d</i>	Boundary Dimensions (mm)					CONE <i>r</i> CUP		Basic Load Ratings (kN) (kgf)				Bearing Numbers
	<i>D</i>	<i>T</i>	<i>B</i>	<i>C</i>	<i>r</i> min.	CUP	<i>C_r</i>	<i>C_{0r}</i>	<i>C_r</i>	<i>C_{0r}</i>		
100	140	25	25	20	1.5	1.5	117	205	12 000	20 900	HR32920J T4CB100 HR32020XJ	
	145	24	22.5	17.5	3	3	113	163	11 500	16 600		
	150	32	32	24	2	1.5	176	294	17 900	30 000		
105	180	37	34	29	3	2.5	255	330	26 000	34 000	HR30220J HR32220J HR30320J HR32320J	
	180	49	46	39	3	2.5	325	450	33 000	46 000		
	215	51.5	47	39	4	3	425	525	43 000	53 500		
	215	77.5	73	60	4	3	565	755	57 500	77 000		
	190	25	25	20	1.5	1.5	119	212	12 100	21 600		HR32921J HR32021XJ HR30221J
160	35	35	26	2.5	2	204	340	20 800	34 500			
190	39	36	30	3	2.5	280	365	28 500	37 500			
110	190	53	50	43	3	2.5	360	510	37 000	52 000	HR32221J HR30321J HR32321J	
	225	53.5	49	41	4	3	455	565	46 500	57 500		
	225	81.5	77	63	4	3	670	925	68 000	94 500		
	150	25	25	20	1.5	1.5	123	224	12 500	22 800		HR32922J HR32022XJ HR30222J
	170	38	38	29	2.5	2	236	390	24 000	40 000		
200	41	38	32	3	2.5	315	420	32 000	43 000			
120	200	56	53	46	3	2.5	400	565	40 500	57 500	HR32222J HR30322J HR32322J	
	240	54.5	50	42	4	3	485	595	49 500	60 500		
	240	84.5	80	65	4	3	675	910	68 500	93 000		
	165	29	29	23	1.5	1.5	161	291	16 400	29 700		HR32924J T4CB120 HR32024XJ
	170	27	25	19.5	3	3	153	243	15 600	24 800		
180	38	38	29	2.5	2	242	405	24 600	41 000			
130	215	43.5	40	34	3	2.5	335	450	34 000	46 000	HR30224J HR32224J HR30324J HR32324J	
	215	61.5	58	50	3	2.5	440	635	44 500	65 000		
	260	59.5	55	46	4	3	535	655	54 500	67 000		
	260	90.5	86	69	4	3	770	1 060	78 500	108 000		
	180	32	32	25	2	1.5	200	365	20 400	37 500		HR32926J HR32026XJ HR30226J
	200	45	45	34	2.5	2	320	535	32 500	54 500		
230	43.75	40	34	4	3	375	505	38 000	51 500			
130	230	67.75	64	54	4	3	530	790	54 000	80 500	HR32226J HR30326J 32326	
	280	63.75	58	49	5	4	650	820	66 000	83 500		
	280	98.75	93	78	5	4	830	1 150	84 500	117 000		

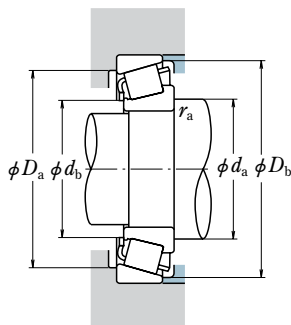

Dynamic Equivalent Load

$$P = XF_r + YF_a$$

$F_a/F_r \leq e$		$F_a/F_r > e$	
X	Y	X	Y
1	0	0.4	Y_1

Static Equivalent Load

$$P_0 = 0.5F_r + Y_0F_a$$

When $F_r > 0.5F_r + Y_0F_a$, use $P_0 = F_r$

The values of e , Y_1 , and Y_0 are given in the table below.

Abutment and Fillet Dimensions (mm)						Eff. Load Centers (mm) a	Constant e	Axial Load Factors		Mass (kg) approx.
d_a	d_b	D_a	D_b	CONE r_a	CUP max.			Y_1	Y_0	
112	106	131	136	1.5	1.5	24.2	0.33	1.8	1.0	1.18
114	106	133	141	2.5	2.5	30.1	0.47	1.3	0.70	1.18
115	106	138	146	2	1.5	32.5	0.46	1.3	0.72	1.95
121	110	163	172	2.5	2	36.1	0.42	1.4	0.79	3.78
122	110	161	174	2.5	2	41.5	0.42	1.4	0.79	5.05
129	119	193	202	3	2.5	41.4	0.35	1.7	0.96	8.41
130	114	190	206	3	2.5	53.2	0.35	1.7	0.96	12.7
117	111	136	141	1.5	1.5	25.3	0.34	1.8	0.96	1.23
122	112	146	155	2	2	34.3	0.44	1.4	0.74	2.48
127	116	172	182	2.5	2	38.1	0.42	1.4	0.79	4.52
128	115	170	183	2.5	2	44.8	0.42	1.4	0.79	6.26
136	124	202	212	3	2.5	43.2	0.35	1.7	0.96	9.52
136	122	199	213	3	2.5	55.2	0.35	1.7	0.96	14.9
122	116	141	146	1.5	1.5	26.5	0.36	1.7	0.93	1.29
128	117	156	165	2	2	35.9	0.43	1.4	0.77	3.09
134	121	181	192	2.5	2	40.1	0.42	1.4	0.79	5.28
135	121	179	193	2.5	2	47.2	0.42	1.4	0.79	7.35
143	129	216	228	3	2.5	45.1	0.35	1.7	0.96	11
144	127	213	229	3	2.5	58.5	0.35	1.7	0.96	17.1
133	126	155	161	1.5	1.5	29.2	0.35	1.7	0.95	1.8
136	126	157	166	2.5	2.5	35.0	0.47	1.3	0.70	1.78
138	127	165	175	2	2	39.7	0.46	1.3	0.72	3.27
145	132	195	206	2.5	2	44.4	0.44	1.4	0.76	6.28
146	131	192	208	2.5	2	52.0	0.44	1.4	0.76	9.0
155	139	234	247	3	2.5	50.0	0.35	1.7	0.96	13.9
155	137	230	248	3	2.5	62.4	0.35	1.7	0.96	21.8
145	138	168	174	2	1.5	31.4	0.34	1.8	0.97	2.46
151	139	184	195	2	2	43.9	0.43	1.4	0.76	5.06
157	146	210	220	3	2.5	45.8	0.44	1.4	0.76	7.25
158	143	205	221	3	2.5	56.9	0.44	1.4	0.76	11.3
167	149	252	265	4	3	52.7	0.35	1.7	0.96	16.6
172	150	248	269	4	3	69.2	0.36	1.7	0.92	26.6

SINGLE-ROW TAPERED ROLLER BEARINGS

Bore Diameter 140 – 190 mm

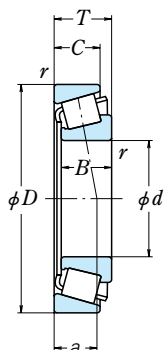

d	Boundary Dimensions (mm)					Basic Load Ratings (kN) / (kgf)				Bearing Numbers	
	D	T	B	C	CONE r min.	C _r	C _{0r}	C _r	C _{0r}		
140	190	32	32	25	2	1.5	206	390	21 000	39 500	HR32928J
	210	45	45	34	2.5	2	325	555	33 000	57 000	HR32028XJ
	250	45.75	42	36	4	3	390	515	40 000	52 500	HR30228J
	250	71.75	68	58	4	3	610	915	62 000	93 500	HR32228J
	300	67.75	62	53	5	4	740	945	75 500	96 500	HR30328J
	300	107.75	102	85	5	4	985	1 440	101 000	147 000	32328
150	210	38	38	30	2.5	2	281	520	28 600	53 000	HR32930J
	225	48	48	36	3	2.5	375	650	38 000	66 500	HR32030XJ
	270	49	45	38	4	3	485	665	49 000	67 500	HR30230J
	270	77	73	60	4	3	705	1 080	71 500	110 000	HR32230J
	320	72	65	55	5	4	825	1 060	84 500	108 000	HR30330J
	320	114	108	90	5	4	1 120	1 700	114 000	174 000	32330
160	220	38	38	30	2.5	2	296	570	30 000	58 000	HR32932J
	240	51	51	38	3	2.5	425	750	43 500	76 500	HR32032XJ
	290	52	48	40	4	3	470	610	47 500	62 000	30232
	290	84	80	67	4	3	795	1 120	81 000	125 000	HR32232J
	340	75	68	58	5	4	915	1 180	93 000	120 000	HR30332J
	340	121	114	95	5	4	1 210	1 770	123 000	181 000	32332
170	230	38	38	30	2.5	2	294	560	30 000	57 000	HR32934J
	260	57	57	43	3	2.5	505	890	51 500	90 500	HR32034XJ
	310	57	52	43	5	4	525	690	53 500	70 500	30234
	310	91	86	71	5	4	930	1 450	94 500	148 000	HR32234J
	360	80	72	62	5	4	1 010	1 310	103 000	134 000	HR30334J
	360	127	120	100	5	4	1 370	2 050	140 000	209 000	32334
180	250	45	45	34	2.5	2	350	685	36 000	69 500	HR32936J
	280	64	64	48	3	2.5	640	1 130	65 000	115 000	HR32036XJ
	320	57	52	43	5	4	520	695	53 000	70 500	30236
	320	91	86	71	5	4	960	1 540	98 000	157 000	HR32236J
	380	83	75	64	5	4	935	1 230	95 500	126 000	30336
	380	134	126	106	5	4	1 520	2 290	155 000	234 000	32336
190	260	45	45	34	2.5	2	365	715	37 000	73 000	HR32938J
	290	64	64	48	3	2.5	650	1 170	66 000	119 000	HR32038XJ
	340	60	55	46	5	4	580	790	59 000	80 500	30238
	340	97	92	75	5	4	1 110	1 770	113 000	181 000	HR32238J
	400	86	78	65	6	5	1 010	1 340	103 000	136 000	30338
	400	140	132	109	6	5	1 660	2 580	169 000	263 000	32338

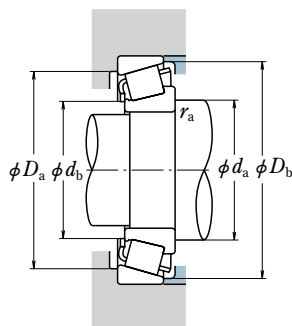

Dynamic Equivalent Load

$$P = XF_r + YF_a$$

$F_a/F_r \leq e$		$F_a/F_r > e$	
X	Y	X	Y
1	0	0.4	Y_1

Static Equivalent Load

$$P_0 = 0.5F_r + Y_0F_a$$

When $F_r > 0.5F_r + Y_0F_a$, use $P_0 = F_r$

The values of e , Y_1 , and Y_0 are given in the table below.

Abutment and Fillet Dimensions (mm)						Eff. Load Centers (mm) <i>a</i>	Constant <i>e</i>	Axial Load Factors		Mass (kg) approx.
<i>d</i> _a	<i>d</i> _b	<i>D</i> _a	<i>D</i> _b	CONE <i>r</i> _a max.	CUP			<i>Y</i> ₁	<i>Y</i> ₀	
155	148	178	184	2	1.5	33.6	0.36	1.7	0.92	2.64
161	148	193	205	2	2	46.6	0.46	1.3	0.72	5.32
169	154	228	240	3	2.5	48.9	0.44	1.4	0.76	8.74
171	152	224	242	3	2.5	60.5	0.44	1.4	0.76	14.3
178	150	269	284	4	3	55.7	0.35	1.7	0.96	21.1
185	161	265	288	4	3	76.4	0.37	1.6	0.88	33.9
168	160	196	203	2	2	36.5	0.33	1.8	1.0	4.05
173	159	206	219	2.5	2	49.8	0.46	1.3	0.72	6.6
180	164	245	258	3	2.5	51.3	0.44	1.4	0.76	11.2
183	166	241	259	3	2.5	64.7	0.44	1.4	0.76	17.8
192	178	288	301	4	3	60.0	0.35	1.7	0.96	25
198	173	282	306	4	3	81.5	0.37	1.6	0.88	41.4
178	170	206	213	2	2	38.7	0.35	1.7	0.95	4.32
184	169	221	234	2.5	2	53.0	0.46	1.3	0.72	7.93
195	178	266	279	3	2.5	55.0	0.43	1.4	0.77	13.1
195	177	259	278	3	2.5	70.5	0.44	1.4	0.76	22.7
203	182	307	323	4	3	62.9	0.35	1.7	0.96	29.2
210	183	301	327	4	3	87.1	0.37	1.6	0.88	48.3
187	179	215	223	2	2	41.7	0.38	1.6	0.86	4.44
196	180	239	253	2.5	2	56.6	0.44	1.4	0.74	10.6
207	189	282	297	4	3	59.8	0.43	1.4	0.77	16.1
209	185	276	300	4	3	76.4	0.44	1.4	0.76	28
214	194	325	342	4	3	67.3	0.35	1.7	0.96	36.4
222	194	319	346	4	3	91.3	0.37	1.6	0.88	57
201	189	231	242	2	2	53.9	0.48	1.3	0.69	6.56
208	192	257	272	2.5	2	60.4	0.42	1.4	0.78	14.3
215	199	291	306	4	3	62.1	0.44	1.4	0.74	16.6
219	199	285	307	4	3	78.8	0.45	1.3	0.73	29.8
230	209	343	360	4	3	72.4	0.36	1.7	0.92	39.3
232	205	336	364	4	3	96.6	0.37	1.6	0.88	66.8
210	199	241	252	2	2	55.3	0.48	1.3	0.69	6.83
219	202	267	283	2.5	2	63.3	0.44	1.4	0.75	14.9
230	212	311	326	4	3	62.7	0.40	1.5	0.82	20.1
231	209	305	327	4	3	80.5	0.44	1.4	0.76	35.2
243	222	362	380	5	4	76.1	0.36	1.7	0.92	46
249	220	355	385	5	4	102.7	0.37	1.6	0.88	78.9

SINGLE-ROW TAPERED ROLLER BEARINGS

Bore Diameter 200 – 380 mm

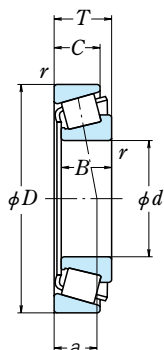

d	Boundary Dimensions (mm)					CONE		Basic Load Ratings				Bearing Numbers
	D	T	B	C	r	CUP	(kN)	{kgf}				
					min.		C _r	C _{0r}	C _r	C _{0r}		
200	280	51	51	39	3	2.5	480	935	48 500	95 000	HR32940J	
	310	70	70	53	3	2.5	760	1 370	77 500	139 000	HR32040XJ	
	360	64	58	48	5	4	645	890	65 500	90 500	30240	
	360	104	98	82	5	4	1 210	1 920	123 000	196 000	HR32240J	
	420	89	80	67	6	5	1 030	1 390	105 000	142 000	30340	
220	420	146	138	115	6	5	1 820	2 870	185 000	292 000	32340	
	300	51	51	39	3	2.5	490	990	50 000	101 000	HR32944J	
	340	76	76	57	4	3	885	1 610	90 500	164 000	HR32044XJ	
	400	72	65	54	5	4	810	1 150	82 500	117 000	30244	
	400	114	108	90	5	4	1 450	2 340	148 000	239 000	HR32244J	
240	460	97	88	73	6	5	1 430	1 990	146 000	203 000	30344	
	460	154	145	122	6	5	2 020	3 200	206 000	325 000	32344	
	320	51	51	39	3	2.5	500	1 040	51 000	107 000	HR32948J	
	360	76	76	57	4	3	920	1 730	94 000	177 000	HR32048XJ	
	440	79	72	60	5	4	990	1 400	101 000	142 000	30248	
260	440	127	120	100	5	4	1 630	2 730	166 000	278 000	32248	
	500	105	95	80	6	5	1 660	2 340	169 000	238 000	30348	
	500	165	155	132	6	5	2 520	4 100	257 000	415 000	32348	
	360	63.5	63.5	48	3	2.5	730	1 450	74 500	148 000	HR32952J	
	400	87	87	65	5	4	1 160	2 160	118 000	220 000	HR32052XJ	
280	480	89	80	67	6	5	1 190	1 700	121 000	174 000	30252	
	480	137	130	106	6	5	1 900	3 300	194 000	335 000	32252	
	380	63.5	63.5	48	3	2.5	765	1 580	78 000	162 000	HR32956J	
	420	87	87	65	5	4	1 180	2 240	120 000	228 000	HR32056XJ	
	500	89	80	67	6	5	1 240	1 900	127 000	194 000	30256	
300	500	137	130	106	6	5	1 950	3 450	199 000	355 000	32256	
	420	76	76	57	4	3	1 010	2 100	103 000	214 000	HR32960J	
	460	100	100	74	5	4	1 440	2 700	147 000	275 000	HR32060XJ	
	540	96	85	71	6	5	1 440	2 100	147 000	214 000	30260	
	540	149	140	115	6	5	2 220	3 700	226 000	380 000	32260	
320	440	76	72	63	4	3	900	1 880	92 000	192 000	32964	
	480	100	100	74	5	4	1 510	2 910	153 000	297 000	HR32064XJ	
	580	104	92	75	6	5	1 640	2 420	168 000	247 000	30264	
340	460	76	76	57	4	3	1 050	2 220	107 000	226 000	HR32968J	
360	480	76	76	57	4	3	1 080	2 340	110 000	239 000	HR32972J	
380	520	87	82	71	5	4	1 210	2 550	124 000	260 000	32976	

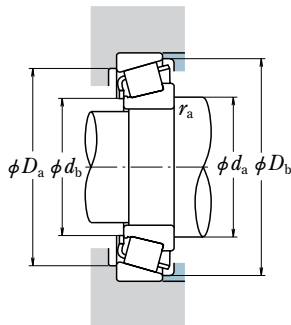

Dynamic Equivalent Load

$$P = XF_r + YF_a$$

$F_a/F_r \leq e$		$F_a/F_r > e$	
X	Y	X	Y
1	0	0.4	Y_1

Static Equivalent Load

$$P_0 = 0.5F_r + Y_0F_a$$

When $F_r > 0.5F_r + Y_0F_a$, use $P_0 = F_r$

The values of e , Y_1 , and Y_0 are given in the table below.

Abutment and Fillet Dimensions (mm)						Eff. Load Centers (mm) a	Constant e	Axial Load Factors		Mass (kg) approx.
d_a	d_b	D_a	D_b	CONE r_a	CUP max.			Y_1	Y_0	
224	212	262	272	2.5	2	54.2	0.39	1.5	0.84	9.65
231	213	285	302	2.5	2	67.4	0.43	1.4	0.77	18.9
242	224	329	345	4	3	65.5	0.40	1.5	0.82	23.8
243	221	323	345	4	3	85.1	0.41	1.5	0.81	42.6
251	229	372	391	5	4	81.4	0.37	1.6	0.88	52.3
260	229	372	403	5	4	106.7	0.37	1.6	0.88	90.9
243	232	281	292	2.5	2	59.2	0.43	1.4	0.78	10.3
254	234	313	331	3	2.5	73.6	0.43	1.4	0.77	24.4
266	246	365	381	4	3	74.6	0.40	1.5	0.82	33.6
268	240	359	387	4	3	96.3	0.44	1.4	0.76	59.4
277	254	414	434	5	4	85.3	0.36	1.7	0.92	72.4
281	250	405	438	5	4	114.9	0.37	1.6	0.88	114
264	252	300	312	2.5	2	65.1	0.46	1.3	0.72	11.1
274	253	332	351	3	2.5	79.1	0.46	1.3	0.72	26.2
290	267	401	422	4	3	85.1	0.44	1.4	0.74	45.2
296	265	397	426	4	3	102.5	0.40	1.5	0.82	78
300	277	449	471	5	4	92.8	0.36	1.7	0.92	92.6
307	273	444	479	5	4	123.2	0.37	1.6	0.88	145
287	273	337	350	2.5	2	69.8	0.41	1.5	0.81	18.6
300	276	368	389	4	3	86.3	0.43	1.4	0.76	38.5
318	291	438	461	5	4	94.5	0.44	1.4	0.74	60.7
319	286	426	460	5	4	116.0	0.45	1.3	0.73	103
308	293	357	371	2.5	2	75.3	0.43	1.4	0.76	20
320	295	386	409	4	3	91.6	0.46	1.3	0.72	40.6
336	313	456	478	5	4	98.5	0.44	1.4	0.74	66.3
339	306	445	481	5	4	123.0	0.47	1.3	0.70	109
335	317	394	409	3	2.5	79.9	0.39	1.5	0.84	31.4
344	317	423	447	4	3	98.4	0.43	1.4	0.76	56.6
357	331	493	517	5	4	105.1	0.44	1.4	0.74	80.6
364	329	486	524	5	4	131.6	0.46	1.3	0.72	132
354	335	412	431	3	2.5	84.3	0.39	1.5	0.84	32
365	338	443	468	4	3	104.5	0.46	1.3	0.72	60
382	354	529	554	5	4	113.7	0.44	1.4	0.74	99.3
374	356	433	449	3	2.5	91.0	0.44	1.4	0.75	34.3
394	376	452	469	3	2.5	96.8	0.46	1.3	0.72	36.1
418	396	487	508	4	3	95.2	0.39	1.6	0.86	49.5

SINGLE-ROW TAPERED ROLLER BEARINGS

Bore Diameter 400 – 520 mm

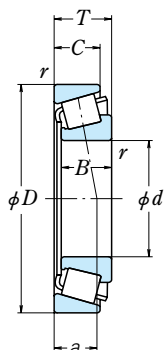

<i>d</i>	Boundary Dimensions (mm)					CONE <i>r</i> CUP		Basic Load Ratings (kN) (kgf)				Bearing Numbers
	<i>D</i>	<i>T</i>	<i>B</i>	<i>C</i>	<i>r</i> min.	<i>r</i> min.	<i>C_r</i>	<i>C_{0r}</i>	<i>C_r</i>	<i>C_{0r}</i>		
400	540	87	82	71	5	4	1 250	2 700	128 000	276 000	32980 R400-1 R400-5	
	600	100	82	80	6	6	1 420	2 730	145 000	279 000		
	600	110	102.5	72.5	6	5	1 790	3 550	183 000	360 000		
	600	115	114.3	89.6	6	6	2 000	4 300	204 000	435 000	R400-4 32080	
	600	125	118	100	6	5	1 960	4 050	200 000	415 000		
	620	130	130	97	6	5	2 360	4 600	241 000	470 000	R400-8 R400-6A R400-3	
	620	140	140	106	6	5	2 480	4 900	253 000	500 000		
750	130	115	77	6	6	2 650	4 150	270 000	425 000			
420	540	76	72	62	5	4	965	2 260	98 500	230 000	R420-2 R420-5	
	560	87	87	67	5	4	1 300	2 810	132 000	287 000		
	560	87	82	72	5	4	1 300	2 810	132 000	287 000	32984 R420-4 32084 R420-6	
	580	95	90	56	6	5	1 310	2 700	133 000	275 000		
	620	125	118	100	6	5	2 000	4 200	204 000	430 000		
800	190	190	135	7.5	7.5	4 050	7 250	415 000	740 000			
425	700	150	140	95	6	6	2 720	5 250	278 000	540 000	R425-1	
430	720	130	120	78	6	6	2 520	4 400	257 000	450 000	R430-1	
440	540	63.5	60	52	5	4	825	2 150	84 000	220 000	R440-3 32088	
	650	130	122	104	6	6	2 230	4 600	227 000	470 000		
460	600	87	82	71	5	4	1 310	3 150	134 000	320 000	R460-1 R460-4 R460-6	
	860	210	210	156	7.5	7.5	5 150	9 550	525 000	975 000		
	910	210	210	150	7.5	7.5	5 150	8 950	525 000	910 000		
470	580	35	35	26	3	2.5	435	1 000	44 000	102 000	R470-51 R470-1	
	610	82	77	63	5	4	1 220	2 840	124 000	289 000		
480	730	150	140	120	7.5	7.5	3 300	6 950	335 000	710 000	R480-1A R480-4	
	950	220	220	155	7.5	7.5	5 700	10 000	580 000	1 020 000		
490	600	35	35	28	3	2.5	460	1 200	47 000	122 000	R490-1	
500	670	84.5	78	60	6	5	1 530	3 150	156 000	325 000	R500-9 R500-5 R500-4	
	750	150	140	120	7.5	7.5	3 350	7 200	340 000	730 000		
	870	170	155	100	9.5	9.5	3 700	7 150	380 000	730 000		
510	640	85	80	65	4	3	1 210	2 980	123 000	305 000	R510-1	
520	670	65	55	45	5	4	955	2 050	97 500	209 000	R520-1	

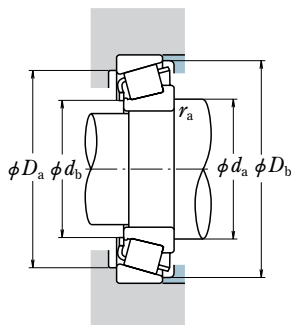

Dynamic Equivalent Load

$$P = XF_r + YF_a$$

$F_a/F_r \leq e$		$F_a/F_r > e$	
X	Y	X	Y
1	0	0.4	Y_1

Static Equivalent Load

$$P_0 = 0.5F_r + Y_0F_a$$

When $F_r > 0.5F_r + Y_0F_a$, use $P_0 = F_r$

The values of e , Y_1 , and Y_0 are given in the table below.

Abutment and Fillet Dimensions (mm)						Eff. Load Centers (mm) a	Constant e	Axial Load Factors		Mass (kg) approx.
d_a	d_b	D_a	D_b	CONE r_a	CUP			Y_1	Y_0	
439	417	508	530	4	3	100.8	0.40	1.5	0.82	52.7
454	429	556	579	5	5	121.5	0.43	1.4	0.77	84.9
460	425	550	586	5	4	164.8	0.70	0.9	0.47	102
457	429	556	580	5	5	106.9	0.33	1.8	0.99	112
453	424	553	580	5	4	115.3	0.36	1.7	0.92	116
457	427	573	599	5	4	117.7	0.37	1.6	0.90	135
457	426	571	600	5	4	121.6	0.37	1.6	0.90	146
485	449	674	713	5	5	188.8	0.70	0.9	0.47	220
456	434	509	529	4	3	108.2	0.46	1.3	0.72	40.4
458	436	528	549	4	3	106.1	0.41	1.5	0.81	54.9
458	436	528	550	4	3	106.1	0.41	1.5	0.81	54.8
469	438	539	569	4	4	159.7	0.74	0.8	0.45	69.4
473	444	572	600	5	4	120.0	0.37	1.6	0.88	121
518	476	716	762	6	6	189.6	0.52	1.2	0.64	408
507	455	625	683	5	5	226.8	0.87	0.7	0.38	216
506	469	655	693	5	5	189.1	0.70	0.9	0.47	194
470	452	514	531	4	3	95.4	0.41	1.5	0.80	29.9
496	467	602	630	5	5	126.3	0.36	1.7	0.92	136
500	477	567	588	4	3	110.8	0.40	1.5	0.82	60.9
560	521	772	818	6	6	187.1	0.41	1.5	0.80	524
572	526	815	868	6	6	211.9	0.52	1.2	0.64	593
498	489	557	565	2.5	2	75.9	0.35	1.7	0.95	19.1
510	488	579	598	4	3	109.2	0.40	1.5	0.82	56.9
546	516	673	705	6	6	143.2	0.36	1.7	0.91	217
595	548	851	903	6	6	215.3	0.49	1.2	0.67	676
518	509	575	583	2	2	75.7	0.33	1.8	0.99	20.7
545	522	635	655	5	4	120.2	0.43	1.4	0.77	75.5
567	536	692	724	6	6	148.1	0.37	1.6	0.88	225
612	552	772	839	8	8	287.1	0.94	0.6	0.35	391
547	526	611	629	2.5	2.5	116.0	0.40	1.5	0.82	58
560	541	636	654	4	3	138.4	0.55	1.1	0.60	50.1

SINGLE-ROW TAPERED ROLLER BEARINGS

Bore Diameter 530 – 950 mm

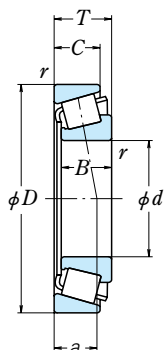

<i>d</i>	Boundary Dimensions (mm)					CONE <i>r</i> CUP		Basic Load Ratings (kN) (kgf)				Bearing Numbers
	<i>D</i>	<i>T</i>	<i>B</i>	<i>C</i>	<i>r</i> min.	<i>r</i> min.	<i>C_r</i>	<i>C_{0r}</i>	<i>C_r</i>	<i>C_{0r}</i>		
530	670	100	95	82	5	4	1 600	4 150	163 000	425 000	R530-1 R530-2	
	680	65	55	45	5	4	970	2 080	99 000	212 000		
550	800	95	90	70	6	6	2 290	4 400	234 000	450 000	R550-1	
560	680	60	60	46	4	3	940	2 480	96 000	252 000	R560-1	
	750	95	90	71	6	5	1 720	4 150	176 000	420 000	R560-4	
	820	150	140	115	7.5	7.5	3 500	7 850	355 000	805 000	R560-5	
	1 080	235	235	170	7.5	7.5	7 700	13 400	785 000	1 370 000	R560-6	
600	780	131	120	100	6	5	2 320	5 700	236 000	580 000	R600-5	
	820	105	95	65	6	5	1 700	4 000	173 000	410 000	R600-4	
	860	150	140	115	7.5	7.5	3 600	8 350	365 000	850 000	R600-3	
	1 000	190	170	115	9.5	9.5	4 600	9 250	470 000	940 000	R600-1	
620	820	90	80	55	6	5	1 700	4 000	173 000	410 000	R620-1	
630	780	100	95	80	7.5	4	1 780	5 050	181 000	515 000	R630-3	
	1 090	190	170	110	12	12	4 800	9 400	490 000	955 000	R630-1	
	1 180	250	225	150	12	12	7 050	13 800	720 000	1 410 000	R630-2	
635	850	105	105	75	5	5	2 360	5 100	240 000	525 000	R635-1	
650	1 050	190	170	110	9.5	9.5	4 700	9 800	480 000	1 000 000	R650-1	
710	920	110	110	83	6	5	2 390	5 600	244 000	570 000	R710-1	
	950	113	106	80	6	6	2 690	5 700	274 000	580 000	R710-2	
750	1 000	110	107	80	6	6	2 760	6 300	281 000	640 000	R750-2	
780	925	95	92	75	6	5	1 960	5 800	200 000	590 000	R780-2	
785	925	95	92	75	6	5	1 960	5 800	200 000	590 000	R785-1	
790	930	95	92	75	6	5	2 240	6 900	228 000	705 000	R790-1	
800	1 020	110	110	85	6	6	3 050	7 700	310 000	785 000	R800-1	
830	1 050	90	90	64	6	5	2 200	5 750	224 000	585 000	R830-2A	
	1 080	156	156	118	6	6	4 550	12 400	460 000	1 260 000	R830-1	
850	1 050	90	90	64	6	5	2 200	5 750	224 000	585 000	R850-1A	
900	1 120	110	110	85	6	6	3 150	8 500	325 000	865 000	R900-1	
908	1 060	92	90	76	6	5	2 080	6 350	212 000	650 000	R908-1	
910	1 062	92	90	76	6	5	2 080	6 350	212 000	650 000	R910-1	
940	1 140	93	90	65	6	5	2 420	6 950	247 000	710 000	R940-1	
	1 210	126	115	80	6	6	3 500	9 100	355 000	925 000	R940-2A	
950	1 170	110	110	85	6	6	3 250	8 950	330 000	910 000	R950-1	

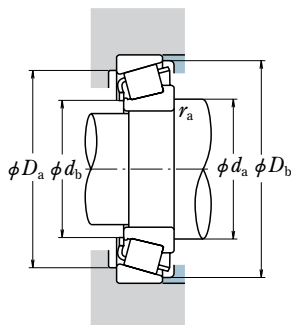

Dynamic Equivalent Load

$$P = XF_r + YF_a$$

$F_a/F_r \leq e$		$F_a/F_r > e$	
X	Y	X	Y
1	0	0.4	Y_1

Static Equivalent Load

$$P_0 = 0.5F_r + Y_0F_a$$

When $F_r > 0.5F_r + Y_0F_a$, use $P_0 = F_r$

The values of e , Y_1 , and Y_0 are given in the table below.

Abutment and Fillet Dimensions (mm)						Eff. Load Centers (mm) a	Constant e	Axial Load Factors		Mass (kg) approx.
d_a	d_b	D_a	D_b	CONE r_a max.	CUP			Y_1	Y_0	
571	547	637	659	4	3	119.7	0.37	1.6	0.88	78.9
570	551	646	665	4	3	140.3	0.55	1.1	0.60	49.4
610	589	751	772	5	5	135.7	0.42	1.4	0.79	149
594	577	654	667	3	2.5	105.7	0.39	1.5	0.85	42.2
611	587	706	728	5	4	129.7	0.40	1.5	0.82	110
630	597	758	792	6	6	164.0	0.41	1.5	0.80	256
682	628	975	1 032	6	6	236.2	0.49	1.2	0.68	928
649	622	738	764	5	4	139.8	0.34	1.7	0.96	146
671	632	766	803	5	4	272.8	0.94	0.6	0.35	148
670	636	797	833	6	6	174.6	0.43	1.4	0.76	272
718	655	897	968	8	8	309.7	0.87	0.7	0.38	527
681	642	766	803	5	4	262.8	0.94	0.6	0.35	117
677	647	741	767	6	3	147.8	0.44	1.4	0.75	101
766	701	974	1 047	10	10	352.5	0.94	0.6	0.35	657
795	712	1 033	1 128	10	10	395.6	0.94	0.6	0.35	1 110
689	661	807	830	4	4	145.3	0.40	1.5	0.82	150
770	699	943	1 017	8	8	340.8	0.93	0.6	0.36	579
764	735	874	901	5	4	168.2	0.44	1.4	0.74	169
766	739	898	925	5	5	176.2	0.46	1.3	0.72	200
811	786	949	972	5	5	162.3	0.40	1.5	0.82	216
822	799	893	913	5	4	140.6	0.34	1.7	0.96	110
825	802	893	913	5	4	140.6	0.34	1.7	0.96	106
830	808	898	918	4	4	140.9	0.35	1.7	0.95	113
853	828	972	995	5	5	158.8	0.37	1.6	0.90	215
892	867	1 007	1 028	4	4	178.8	0.44	1.4	0.75	183
898	859	1 022	1 060	5	5	206.8	0.44	1.4	0.75	367
902	877	1 007	1 028	4	4	178.8	0.44	1.4	0.75	165
956	928	1 072	1 099	5	5	184.7	0.41	1.5	0.81	239
951	928	1 027	1 047	5	4	153.8	0.35	1.7	0.95	129
952	929	1 028	1 048	5	4	153.8	0.35	1.7	0.95	129
995	967	1 094	1 118	5	4	217.0	0.51	1.2	0.65	187
1 016	974	1 146	1 186	5	5	316.2	0.73	0.8	0.45	341
1 007	978	1 122	1 150	5	5	199.0	0.43	1.4	0.77	252

SINGLE-ROW TAPERED ROLLER BEARINGS

Bore Diameter 1 010 – 1 900 mm

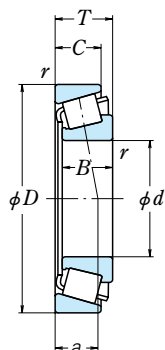

d	D	Boundary Dimensions (mm)					Basic Load Ratings				Bearing Numbers
		T	B	C	CONE r min.	CUP	(kN)		{kgf}		
1 010	1 210	95	75	65	4	3	1 650	4 800	169 000	485 000	R1010-1
1 050	1 600	270	245	180	9.5	9.5	9 350	23 700	955 000	2 420 000	R1050-1
1 060	1 600	270	245	180	9.5	9.5	9 350	23 700	955 000	2 420 000	R1060-1
1 200	1 400	100	92	64	6	6	2 570	8 400	262 000	855 000	R1200-1
1 320	1 720	236.5	230	175	7.5	7.5	9 600	28 800	980 000	2 930 000	R1320-1
1 580	1 820	120	110	80	6	6	3 900	13 200	395 000	1 350 000	R1580-1
1 900	2 140	120	110	78	6	6	4 000	14 700	410 000	1 500 000	R1900-1

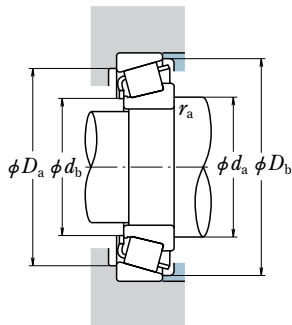

Dynamic Equivalent Load

$$P = XF_r + YF_a$$

$F_a/F_r \leq e$		$F_a/F_r > e$	
X	Y	X	Y
1	0	0.4	Y_1

Static Equivalent Load

$$P_0 = 0.5F_r + Y_0F_a$$

When $F_r > 0.5F_r + Y_0F_a$, use $P_0 = F_r$

The values of e , Y_1 , and Y_0 are given in the table below.

Abutment and Fillet Dimensions (mm)						Eff. Load Centers (mm) a	Constant e	Axial Load Factors		Mass (kg) approx.
d_a	d_b	D_a	D_b	CONE r_a max.	CUP r_a			Y_1	Y_0	
1 064	1 039	1 162	1 188	2.5	2.5	303.8	0.70	0.9	0.47	182
1 215	1 120	1 454	1 554	8	8	500.6	0.87	0.7	0.38	1 840
1 220	1 125	1 454	1 554	8	8	500.6	0.87	0.7	0.38	1 810
1 259	1 225	1 346	1 380	5	5	354.6	0.72	0.8	0.46	243
1 427	1 366	1 620	1 683	6	6	363.2	0.52	1.2	0.64	1 390
1 647	1 615	1 767	1 797	5	5	380.1	0.58	1.0	0.57	453
1 968	1 930	2 082	2 118	5	5	523.2	0.70	0.9	0.47	535

SINGLE-ROW TAPERED ROLLER BEARINGS (INCH DESIGN)

Bore Diameter 100.000 – 101.600 mm

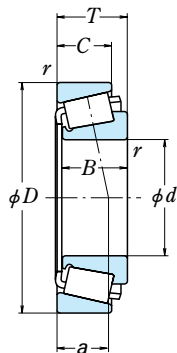

d	Boundary Dimensions (mm/inch)					Basic Load Ratings (kN) (kgf)				
	D	T	B	C	CONE r min.	CUP	C_r	C_{0r}	C_r	C_{0r}
100.000 3.9370	150.000 5.9055	32.000 1.2598	30.000 1.1811	26.000 1.0236	2.3	2.3	146	235	14 900	24 000
	155.000 6.1024	36.000 1.4173	35.000 1.3780	28.000 1.1024	3.0	2.5	191	325	19 500	33 000
	160.000 6.2992	41.000 1.6142	40.000 1.5748	32.000 1.2598	3.0	2.5	239	380	24 400	38 500
	180.975 7.1250	47.625 1.8750	48.006 1.8900	38.100 1.5000	3.5	3.3	258	375	26 300	38 500
	190.500 7.5000	57.150 2.2500	57.531 2.2650	44.450 1.7500	6.0	3.3	355	500	36 000	51 000
	212.725 8.3750	66.675 2.6250	66.675 2.6250	53.975 2.1250	3.5	3.3	570	810	58 000	82 500
100.012 3.9375	157.162 6.1875	36.512 1.4375	36.116 1.4219	26.195 1.0313	3.5	3.3	191	310	19 500	31 500
	161.925 6.3750	39.688 1.5625	36.116 1.4219	29.370 1.1563	3.5	3.3	191	310	19 500	31 500
101.600 4.0000	146.050 5.7500	21.433 0.8438	21.433 0.8438	16.670 0.6563	1.5	1.5	85.5	165	8 750	16 800
	157.162 6.1875	36.512 1.4375	36.116 1.4219	26.195 1.0313	3.5	3.3	191	310	19 500	31 500
	157.162 6.1875	36.512 1.4375	36.116 1.4219	26.195 1.0313	8.0	3.3	191	310	19 500	31 500
	161.925 6.3750	36.512 1.4375	36.116 1.4219	26.195 1.0313	3.5	3.3	191	310	19 500	31 500
	168.275 6.6250	41.275 1.6250	41.275 1.6250	34.925 1.3750	3.5	3.3	223	345	22 700	35 000
	168.275 6.6250	41.275 1.6250	41.275 1.6250	30.162 1.1875	3.5	3.3	223	345	22 700	35 000
	180.975 7.1250	47.625 1.8750	48.006 1.8900	38.100 1.5000	3.5	3.3	258	375	26 300	38 500

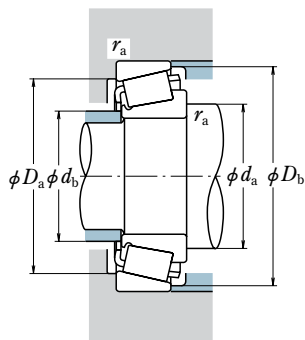

Dynamic Equivalent Load

$$P = XF_r + YF_a$$

$F_a/F_r \leq e$		$F_a/F_r > e$	
X	Y	X	Y
1	0	0.4	Y_1

Static Equivalent Load

$$P_0 = 0.5F_r + Y_0F_a$$

When $F_r > 0.5F_r + Y_0F_a$, use $P_0 = F_r$

The values of e , Y_1 , and Y_0 are given in the table below.

Bearing Numbers	Abutment and Fillet Dimensions (mm)						Eff. Load Centers (mm) a	Constant e	Axial Load Factors		Mass (kg) approx.
	d_a	d_b	D_a	D_b	CONE r_a max.	CUP r_a			Y_1	Y_0	
▲JLM820048 / JLM820012	116	106	136	147	2.3	2.3	36.8	0.50	1.2	0.66	1.89
▲JM720249 / JM720210	118	108	140	150	3.0	2.5	36.8	0.47	1.3	0.70	2.45
▲JHM720249 / JHM720210	119	107	144	155	3.0	2.5	38.2	0.47	1.3	0.70	3.07
783 / 772	123	111	160	172	3.5	3.3	39.1	0.39	1.6	0.86	4.96
863X / 854	127	111	168	181	6.0	3.3	41.8	0.33	1.8	0.99	6.81
#HH224334 / HH224310	133	118	191	206	3.5	3.3	47.3	0.33	1.8	1.0	11.4
52393 / 52618	119	108	142	153	3.5	3.3	36.1	0.47	1.3	0.69	2.51
52393 / 52638	119	108	143	155	3.5	3.3	39.2	0.47	1.3	0.69	2.92
L521945 / L521910	117	111	136	141	1.5	1.5	25.9	0.39	1.5	0.84	1.19
52400 / 52618	120	109	142	153	3.5	3.3	36.1	0.47	1.3	0.69	2.45
52401 / 52618	125	109	142	153	8.0	3.3	36.1	0.47	1.3	0.69	2.42
52400 / 52637	120	109	144	155	3.5	3.3	36.1	0.47	1.3	0.69	2.69
687 / 672A	121	109	149	162	3.5	3.3	38.3	0.47	1.3	0.70	3.49
687 / 672	121	109	149	161	3.5	3.3	38.3	0.47	1.3	0.70	3.39
780 / 772	124	111	160	172	3.5	3.3	39.1	0.39	1.6	0.86	4.86

Note ▲ The tolerances are listed in tables 2 to 4 on page B 99.
Bore tolerances are listed in table 2.4 on page A24, but their tolerances are negative.

SINGLE-ROW TAPERED ROLLER BEARINGS (INCH DESIGN)

Bore Diameter 101.600 – 106.362 mm

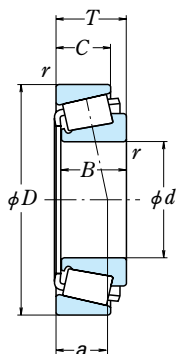

d	Boundary Dimensions (mm/inch)				CONE		Basic Load Ratings (kN) (kgf)			
	D	T	B	C	r min.	CUP	C_r	C_{0r}	C_r	C_{0r}
101.600 4.0000	190.500 7.5000	57.150 2.2500	57.531 2.2650	46.038 1.8125	8.0	3.3	390	520	39 500	53 500
	190.500 7.5000	57.150 2.2500	57.531 2.2650	44.450 1.7500	8.0	3.3	355	500	36 000	51 000
	200.000 7.8740	52.761 2.0772	49.212 1.9375	34.925 1.3750	3.5	3.3	315	425	32 000	43 500
	200.025 7.8750	61.912 2.4375	57.531 2.2650	50.800 2.0000	8.0	3.3	390	520	39 500	53 500
	212.725 8.3750	66.675 2.6250	66.675 2.6250	53.975 2.1250	7.0	3.3	570	810	58 000	82 500
	212.725 8.3750	66.675 2.6250	66.675 2.6250	53.975 2.1250	7.0	3.3	475	700	48 500	71 500
	250.825 9.8750	76.200 3.0000	73.025 2.8750	50.800 2.0000	6.4	6.4	485	635	49 500	65 000
	250.825 9.8750	76.200 3.0000	73.025 2.8750	50.800 2.0000	6.4	6.4	530	645	54 000	65 500
	250.825 9.8750	76.200 3.0000	73.025 2.8750	50.800 2.0000	6.4	3.3	530	645	54 000	65 500
	104.775 4.1250	180.975 7.1250	47.625 1.8750	48.006 1.8900	38.100 1.5000	3.5	3.3	258	375	26 300
180.975 7.1250		47.625 1.8750	48.006 1.8900	38.100 1.5000	6.4	3.3	258	375	26 300	38 500
180.975 7.1250		47.625 1.8750	48.006 1.8900	38.100 1.5000	7.0	3.3	258	375	26 300	38 500
106.362 4.1875	190.500 7.5000	47.625 1.8750	49.212 1.9375	34.925 1.3750	3.5	3.3	296	465	30 000	47 000
	168.275 6.6250	36.513 1.4375	36.512 1.4375	26.988 1.0625	3.5	3.3	195	320	19 800	33 000

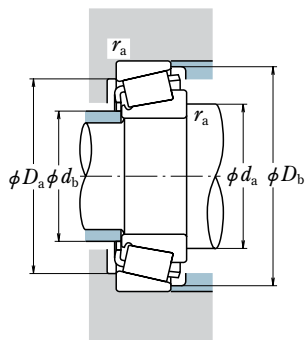

Dynamic Equivalent Load

$$P = XF_r + YF_a$$

$F_a/F_r \leq e$		$F_a/F_r > e$	
X	Y	X	Y
1	0	0.4	Y_1

Static Equivalent Load

$$P_0 = 0.5F_r + Y_0F_a$$

When $F_r > 0.5F_r + Y_0F_a$, use $P_0 = F_r$

The values of e , Y_1 , and Y_0 are given in the table below.

Bearing Numbers	Abutment and Fillet Dimensions (mm)						Eff. Load Centers (mm) \bar{a}	Constant e	Axial Load Factors		Mass (kg) approx.
	d_a	d_b	D_a	D_b	CONE r_a max.	CUP			Y_1	Y_0	
HH221449 / HH221410	131	113	170	183	8.0	3.3	42.3	0.33	1.8	0.99	6.79
861 / 854	130	112	168	181	8.0	3.3	41.8	0.33	1.8	0.99	6.68
98400 / 98788	132	114	174	191	3.5	3.3	54.4	0.63	0.95	0.52	6.81
HH221449 / HH221416	131	113	174	188	8.0	3.3	47.0	0.33	1.8	0.99	8.29
HH224335 / HH224310	137	119	191	206	7.0	3.3	47.3	0.33	1.8	1.0	11.2
941 / 932	136	118	187	201	7.0	3.3	46.9	0.33	1.8	1.0	11.2
EE215040 / 215098	146	122	207	236	6.4	6.4	72.8	0.70	0.86	0.47	17
HH923649 / HH923610	145	118	210	238	6.4	6.4	73.3	0.70	0.86	0.47	16.8
HH923649 / HH923611	145	118	213	238	6.4	3.3	73.3	0.70	0.86	0.47	16.8
782 / 772	125	113	160	172	3.5	3.3	39.1	0.39	1.6	0.86	4.67
786 / 772	128	113	160	172	6.4	3.3	39.1	0.39	1.6	0.86	4.65
787 / 772	129	113	160	172	7.0	3.3	39.1	0.39	1.6	0.86	4.65
71412 / 71750	131	119	171	183	3.5	3.3	40.1	0.42	1.4	0.79	5.71
56418 / 56650	126	114	148	160	3.5	3.3	38.6	0.50	1.2	0.66	2.73
56418 / 56662	126	114	150	161	3.5	3.3	38.6	0.50	1.2	0.66	2.91

SINGLE-ROW TAPERED ROLLER BEARINGS (INCH DESIGN)

Bore Diameter 107.950 – 110.000 mm

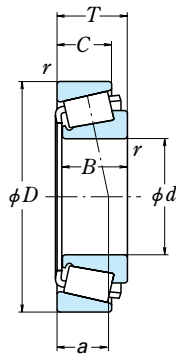

<i>d</i>	Boundary Dimensions (mm/inch)					Basic Load Ratings (kN) (kgf)				
	<i>D</i>	<i>T</i>	<i>B</i>	<i>C</i>	CONE <i>r</i> min.	CUP	<i>C_r</i>	<i>C_{0r}</i>	<i>C_r</i>	<i>C_{0r}</i>
107.950 4.2500	158.750 6.2500	23.020 0.9063	21.438 0.8440	15.875 0.6250	3.5	3.3	102	165	10 400	16 800
	159.987 6.2987	34.925 1.3750	34.925 1.3750	26.988 1.0625	3.5	3.3	164	315	16 700	32 000
	161.925 6.3750	34.925 1.3750	34.925 1.3750	26.988 1.0625	3.5	3.3	164	280	16 800	28 600
	165.100 6.5000	36.512 1.4375	36.512 1.4375	26.988 1.0625	3.5	3.3	195	320	19 800	33 000
	168.275 6.6250	36.512 1.4375	36.512 1.4375	26.988 1.0625	3.5	3.3	195	320	19 800	33 000
	190.500 7.5000	47.625 1.8750	49.212 1.9375	34.925 1.3750	3.5	3.3	296	465	30 000	47 000
	212.725 8.3750	66.675 2.6250	66.675 2.6250	53.975 2.1250	8.0	3.3	570	810	58 000	82 500
	212.725 8.3750	66.675 2.6250	66.675 2.6250	53.975 2.1250	8.0	3.3	475	700	48 500	71 500
109.952 4.3288	190.500 7.5000	47.625 1.8750	49.212 1.9375	34.925 1.3750	3.5	3.3	296	465	30 000	47 000
109.987 4.3302	159.987 6.2987	34.925 1.3750	34.925 1.3750	26.988 1.0625	8.0	3.3	164	315	16 700	32 000
	159.987 6.2987	34.925 1.3750	34.925 1.3750	26.988 1.0625	3.5	3.3	164	315	16 700	32 000
109.992 4.3304	177.800 7.0000	41.275 1.6250	41.275 1.6250	30.162 1.1875	3.5	3.3	232	375	23 700	38 000
110.000 4.3307	165.000 6.4961	35.000 1.3780	35.000 1.3780	26.500 1.0433	3.0	2.5	195	320	19 800	33 000
	180.000 7.0866	47.000 1.8504	46.000 1.8110	38.000 1.4961	3.0	2.5	310	490	31 500	50 000

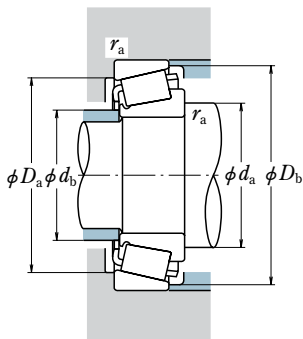

Dynamic Equivalent Load

$$P = XF_r + YF_a$$

$F_a/F_r \leq e$		$F_a/F_r > e$	
X	Y	X	Y
1	0	0.4	Y_1

Static Equivalent Load

$$P_0 = 0.5F_r + Y_0F_a$$

When $F_r > 0.5F_r + Y_0F_a$, use $P_0 = F_r$

The values of e , Y_1 , and Y_0 are given in the table below.

Bearing Numbers	Abutment and Fillet Dimensions (mm)						Eff. Load Centers (mm) a	Constant e	Axial Load Factors		Mass (kg) approx.
	d_a	d_b	D_a	D_b	CONE r_a max.	CUP r_a			Y_1	Y_0	
37425 / 37625	124	115	143	152	3.5	3.3	37.0	0.61	0.99	0.54	1.37
LM522546 / LM522510	126	117	145	154	3.5	3.3	33.7	0.40	1.5	0.82	2.43
48190 / 48120	126	115	145	157	3.5	3.3	38.7	0.51	1.2	0.65	2.42
56425 / 56650	127	115	148	160	3.5	3.3	38.6	0.50	1.2	0.66	2.66
56425 / 56662	127	115	150	161	3.5	3.3	38.6	0.50	1.2	0.66	2.83
71425 / 71750	133	121	171	183	3.5	3.3	40.1	0.42	1.4	0.79	5.5
HH224340 / HH224310	142	122	191	206	8.0	3.3	47.3	0.33	1.8	1.0	10.6
936 / 932	140	121	187	201	8.0	3.3	46.9	0.33	1.8	1.0	10.7
71432 / 71750	134	122	171	183	3.5	3.3	40.1	0.42	1.4	0.79	5.37
LM522548 / LM522510	132	118	145	154	8.0	3.3	33.7	0.40	1.5	0.82	2.31
LM522549 / LM522510	127	118	145	154	3.5	3.3	33.7	0.40	1.5	0.82	2.33
64433 / 64700	132	119	160	173	3.5	3.3	42.4	0.52	1.2	0.64	3.75
▲JM822049 / JM822010	127	116	149	160	3.0	2.5	38.1	0.50	1.2	0.66	2.48
▲JHM522649 / JHM522610	131	118	162	174	3.0	2.5	40.9	0.41	1.5	0.81	4.62

Note ▲ The tolerances are listed in tables 2 to 4 on page B 99.

SINGLE-ROW TAPERED ROLLER BEARINGS (INCH DESIGN)

Bore Diameter 111.125 – 115.000 mm

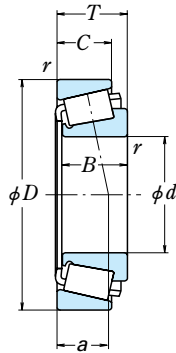

<i>d</i>	Boundary Dimensions (mm/inch)				CONE		Basic Load Ratings (kN) (kgf)			
	<i>D</i>	<i>T</i>	<i>B</i>	<i>C</i>	<i>r</i> min.	CUP	<i>C_r</i>	<i>C_{0r}</i>	<i>C_r</i>	<i>C_{0r}</i>
111.125 4.3750	190.500 7.5000	47.625 1.8750	49.212 1.9375	34.925 1.3750	3.5	3.3	296	465	30 000	47 000
	214.312 8.4375	55.562 2.1875	52.388 2.0625	39.688 1.5625	3.5	3.3	355	490	36 500	50 000
114.300 4.5000	152.400 6.0000	21.433 0.8438	21.433 0.8438	16.670 0.6563	1.5	1.5	89.5	178	9 100	18 100
	177.800 7.0000	41.275 1.6250	41.275 1.6250	30.162 1.1875	3.5	3.3	232	375	23 700	38 000
	180.000 7.0866	34.925 1.3750	31.750 1.2500	25.400 1.0000	3.5	0.8	174	254	17 800	25 900
	180.975 7.1250	34.925 1.3750	31.750 1.2500	25.400 1.0000	3.5	3.3	174	254	17 800	25 900
	190.500 7.5000	47.625 1.8750	49.212 1.9375	34.925 1.3750	3.5	3.3	296	465	30 000	47 000
	212.725 8.3750	66.675 2.6250	66.675 2.6250	53.975 2.1250	7.0	3.3	570	810	58 000	82 500
	212.725 8.3750	66.675 2.6250	66.675 2.6250	53.975 2.1250	7.0	3.3	475	700	48 500	71 500
	228.600 9.0000	53.975 2.1250	49.428 1.9460	38.100 1.5000	3.5	3.3	375	530	38 000	54 000
	228.600 9.0000	53.975 2.1250	49.428 1.9460	38.100 1.5000	3.5	3.3	330	475	33 500	48 500
	273.050 10.7500	82.550 3.2500	82.550 3.2500	53.975 2.1250	6.4	6.4	685	870	70 000	88 500
	279.400 11.0000	82.550 3.2500	82.550 3.2500	53.975 2.1250	6.4	6.4	685	870	70 000	88 500
114.976 4.5266	212.725 8.3750	66.675 2.6250	66.675 2.6250	53.975 2.1250	7.0	3.3	570	810	58 000	82 500
115.000 4.5276	177.800 7.0000	41.275 1.6250	41.275 1.6250	30.162 1.1875	3.5	3.3	232	375	23 700	38 000

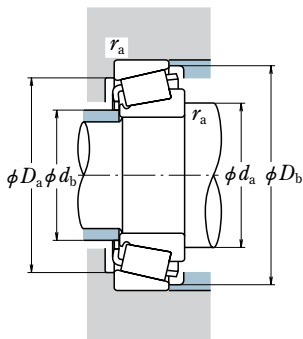

Dynamic Equivalent Load

$$P = XF_r + YF_a$$

$F_a/F_r \leq e$		$F_a/F_r > e$	
X	Y	X	Y
1	0	0.4	Y_1

Static Equivalent Load

$$P_0 = 0.5F_r + Y_0F_a$$

When $F_r > 0.5F_r + Y_0F_a$, use $P_0 = F_r$

The values of e , Y_1 , and Y_0 are given in the table below.

Bearing Numbers	Abutment and Fillet Dimensions (mm)						Eff. Load Centers (mm) \bar{a}	Constant e	Axial Load Factors		Mass (kg)
	d_a	d_b	D_a	D_b	CONE r_a max.	CUP r_a			Y_1	Y_0	
71437 / 71750	135	122	171	183	3.5	3.3	40.1	0.42	1.4	0.79	5.29
H924045 / H924010	143	124	187	206	3.5	3.3	62.4	0.67	0.89	0.49	8.32
L623149 / L623110	127	121	142	148	1.5	1.5	27.4	0.41	1.5	0.80	1.07
64450 / 64700	135	122	160	173	3.5	3.3	42.4	0.52	1.2	0.64	3.5
**68450 / 68709	134	124	165	173	3.5	0.8	40.0	0.50	1.2	0.66	2.95
68450 / 68712	134	124	163	174	3.5	3.3	40.0	0.50	1.2	0.66	2.93
71450 / 71750	136	124	171	183	3.5	3.3	40.1	0.42	1.4	0.79	5.07
HH224346 / HH224310	144	125	191	206	7.0	3.3	47.3	0.33	1.8	1.0	10.1
938 / 932	142	124	187	201	7.0	3.3	46.9	0.33	1.8	1.0	10.1
HM926740 / HM926710	152	133	201	223	3.5	3.3	67.7	0.74	0.81	0.45	9.52
97450 / 97900	151	131	198	219	3.5	3.3	67.5	0.74	0.82	0.45	9.52
HH926744 / HH926710	162	134	234	261	6.4	6.4	77.0	0.63	0.95	0.52	21.8
HH926744 / HH926716	162	134	237	264	6.4	6.4	77.0	0.63	0.95	0.52	23
HH224349 / HH224310	144	125	191	206	7.0	3.3	47.3	0.33	1.8	1.0	10
#64452 / 64700	135	122	160	173	3.5	3.3	42.4	0.52	1.2	0.64	3.46

Note ** The maximum outside diameter is listed and its tolerance is negative (See table 2.4 on page A 24)

Bore tolerances are listed in table 2.4 on page A24, but their tolerances are negative.

SINGLE-ROW TAPERED ROLLER BEARINGS (INCH DESIGN)

Bore Diameter 115.087 – 123.825 mm

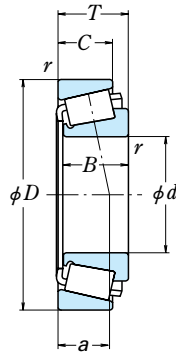

<i>d</i>	Boundary Dimensions (mm/inch)					Basic Load Ratings (kN) (kgf)				
	<i>D</i>	<i>T</i>	<i>B</i>	<i>C</i>	CONE <i>r</i> min.	CUP <i>r</i>	<i>C_r</i>	<i>C_{0r}</i>	<i>C_r</i>	<i>C_{0r}</i>
115.087 4.5310	190.500 7.5000	47.625 1.8750	49.212 1.9375	34.925 1.3750	3.5	3.3	296	465	30 000	47 000
117.475 4.6250	180.975 7.1250	34.925 1.3750	31.750 1.2500	25.400 1.0000	3.5	3.3	174	254	17 800	25 900
119.964 4.7230	215.000 8.4646	47.625 1.8750	47.625 1.8750	34.925 1.3750	3.5	3.3	287	495	29 300	50 000
	215.900 8.5000	47.625 1.8750	47.625 1.8750	34.925 1.3750	3.5	3.3	287	495	29 300	50 000
120.000 4.7244	170.000 6.6929	25.400 1.0000	25.400 1.0000	19.050 0.7500	3.3	3.3	130	219	13 200	22 300
	174.625 6.8750	35.720 1.4063	36.512 1.4375	27.783 1.0938	3.5	1.5	212	385	21 600	39 000
	230.000 9.0551	53.975 2.1250	49.428 1.9460	38.100 1.5000	3.5	3.3	330	475	33 500	48 500
120.650 4.7500	160.338 6.3125	21.433 0.8438	21.433 0.8438	16.670 0.6563	1.5	1.5	92.5	190	9 450	19 400
	182.562 7.1875	39.688 1.5625	38.100 1.5000	33.338 1.3125	3.5	3.3	228	445	23 200	45 000
	206.375 8.1250	47.625 1.8750	47.625 1.8750	34.925 1.3750	3.3	3.3	320	530	32 500	54 000
	234.950 9.2500	63.500 2.5000	63.500 2.5000	49.212 1.9375	6.4	3.3	510	790	52 000	80 500
	254.000 10.0000	77.788 3.0625	82.550 3.2500	61.913 2.4375	9.7	6.4	675	975	69 000	99 500
	273.050 10.7500	82.550 3.2500	82.550 3.2500	53.975 2.1250	6.4	6.4	685	870	70 000	88 500
	279.400 11.0000	82.550 3.2500	82.550 3.2500	53.975 2.1250	6.4	6.4	685	870	70 000	88 500
123.825 4.8750	182.562 7.1875	39.688 1.5625	38.100 1.5000	33.338 1.3125	3.5	3.3	228	445	23 200	45 000

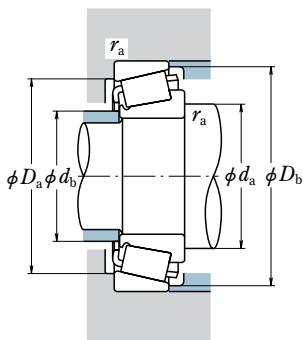

Dynamic Equivalent Load

$$P = XF_r + YF_a$$

$F_a/F_r \leq e$		$F_a/F_r > e$	
X	Y	X	Y
1	0	0.4	Y_1

Static Equivalent Load

$$P_0 = 0.5F_r + Y_0F_a$$

When $F_r > 0.5F_r + Y_0F_a$, use $P_0 = F_r$

The values of e , Y_1 , and Y_0 are given in the table below.

Bearing Numbers	Abutment and Fillet Dimensions (mm)						Eff. Load Centers (mm) \bar{a}	Constant e	Axial Load Factors		Mass (kg) approx.
	d_a	d_b	D_a	D_b	CONE r_a max.	CUP r_a			Y_1	Y_0	
71453 / 71750	137	124	171	183	3.5	3.3	40.1	0.42	1.4	0.79	5.02
68462 / 68712	135	125	163	174	3.5	3.3	40.0	0.50	1.2	0.66	2.78
74472 / 74846X	153	140	195	208	3.5	3.3	48.4	0.49	1.2	0.68	7.33
74472 / 74850	153	140	195	209	3.5	3.3	48.4	0.49	1.2	0.68	7.42
▲JL724348 / JL724314	135	127	155	164	3.3	3.3	32.9	0.46	1.3	0.72	1.67
#M224748 / M224710	137	128	162	169	3.5	1.5	32.2	0.33	1.8	0.99	2.76
97472X / 97905X	154	134	199	220	3.5	3.3	67.6	0.74	0.82	0.45	9.27
L624549 / L624510	133	127	150	155	1.5	1.5	29.3	0.44	1.4	0.76	1.18
48282 / 48220	142	132	167	177	3.5	3.3	34.2	0.31	2.0	1.1	3.69
795 / 792	149	134	186	199	3.3	3.3	45.7	0.46	1.3	0.72	6.35
95475 / 95925	159	140	212	226	6.4	3.3	50.5	0.37	1.6	0.89	12.3
HH228340 / HH228310	163	140	223	242	9.7	6.4	55.0	0.34	1.8	0.97	18.4
HH926749 / HH926710	165	137	234	261	6.4	6.4	77.0	0.63	0.95	0.52	21
HH926749 / HH926716	165	137	237	264	6.4	6.4	77.0	0.63	0.95	0.52	22.2
48286 / 48220	143	134	167	177	3.5	3.3	34.2	0.31	2.0	1.1	3.51

- Notes** ▲ The tolerances are listed in tables 2 to 4 on page B 99.
 # Bore tolerances are listed in table 2.4 on page A24, but their tolerances are negative.

SINGLE-ROW TAPERED ROLLER BEARINGS (INCH DESIGN)

Bore Diameter 124.943 – 127.000 mm

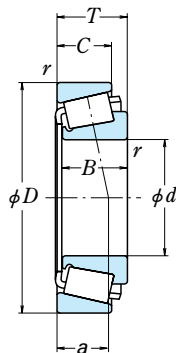

<i>d</i>	Boundary Dimensions (mm/inch)					Basic Load Ratings (kN) (kgf)				
	<i>D</i>	<i>T</i>	<i>B</i>	<i>C</i>	CONE <i>r</i> min.	CUP <i>r</i>	<i>C_r</i>	<i>C_{0r}</i>	<i>C_r</i>	<i>C_{0r}</i>
124.943 4.9190	234.950 9.2500	63.500 2.5000	63.500 2.5000	49.212 1.9375	6.4	3.3	510	790	52 000	80 500
125.000 4.9213	175.000 6.8898	25.400 1.0000	25.400 1.0000	18.288 0.7200	3.3	3.3	134	232	13 700	23 600
125.298 4.9330	228.600 9.0000	53.975 2.1250	49.428 1.9460	38.100 1.5000	3.5	3.3	375	530	38 000	54 000
127.000 5.0000	165.895 6.5313	18.258 0.7188	17.462 0.6875	13.495 0.5313	1.5	1.5	84.5	149	8 650	15 200
	169.862 6.6875	25.400 1.0000	26.195 1.0313	20.638 0.8125	1.5	1.5	123	251	12 600	25 600
	180.975 7.1250	25.400 1.0000	26.195 1.0313	20.638 0.8125	1.5	1.5	123	251	12 600	25 600
	182.562 7.1875	39.688 1.5625	38.100 1.5000	33.338 1.3125	3.5	3.3	228	445	23 200	45 000
	196.850 7.7500	46.038 1.8125	46.038 1.8125	38.100 1.5000	3.5	3.3	315	560	32 000	57 500
	203.200 8.0000	46.038 1.8125	46.038 1.8125	38.100 1.5000	3.5	3.3	315	560	32 000	57 500
	215.900 8.5000	47.625 1.8750	47.625 1.8750	34.925 1.3750	3.5	3.3	287	495	29 300	50 000
	217.488 8.5625	47.625 1.8750	47.625 1.8750	34.925 1.3750	3.5	3.3	287	495	29 300	50 000
	228.600 9.0000	53.975 2.1250	49.428 1.9460	38.100 1.5000	3.5	3.3	375	530	38 000	54 000
	228.600 9.0000	53.975 2.1250	49.428 1.9460	38.100 1.5000	3.5	3.3	330	475	33 500	48 500
	234.950 9.2500	63.500 2.5000	63.500 2.5000	49.212 1.9375	6.4	3.3	505	790	51 500	80 500
	234.950 9.2500	63.500 2.5000	68.715 2.7053	49.212 1.9375	9.7	3.3	505	790	51 500	80 500

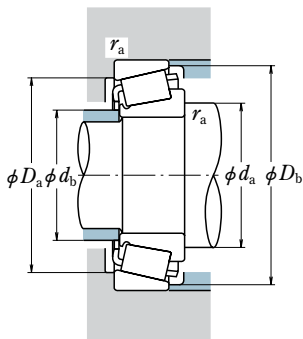

Dynamic Equivalent Load

$$P = XF_r + YF_a$$

$F_a/F_r \leq e$		$F_a/F_r > e$	
X	Y	X	Y
1	0	0.4	Y_1

Static Equivalent Load

$$P_0 = 0.5F_r + Y_0F_a$$

When $F_r > 0.5F_r + Y_0F_a$, use $P_0 = F_r$

The values of e , Y_1 , and Y_0 are given in the table below.

Bearing Numbers	Abutment and Fillet Dimensions (mm)						Eff. Load Centers (mm) \bar{a}	Constant e	Axial Load Factors		Mass (kg)
	d_a	d_b	D_a	D_b	CONE r_a max.	CUP r_a			Y_1	Y_0	
95491 / 95925	162	142	212	226	6.4	3.3	50.5	0.37	1.6	0.89	11.9
▲JL725346 / JL725316	141	131	160	170	3.3	3.3	34.3	0.48	1.3	0.69	1.76
HM926745 / HM926710	157	138	201	223	3.5	3.3	67.7	0.74	0.81	0.45	8.72
LL225749 / LL225710	138	133	157	161	1.5	1.5	24.2	0.33	1.8	0.99	0.93
L225849 / L225810	140	134	159	165	1.5	1.5	28.1	0.33	1.8	0.99	1.65
L225849 / L225818	140	134	165	170	1.5	1.5	28.1	0.33	1.8	0.99	2.14
48290 / 48220	145	135	167	177	3.5	3.3	34.2	0.31	2.0	1.1	3.33
67388 / 67322	150	139	180	192	3.5	3.3	39.7	0.34	1.7	0.96	5.2
67388 / 67320	150	139	183	195	3.5	3.3	39.7	0.34	1.7	0.96	5.8
74500 / 74850	157	143	195	209	3.5	3.3	48.4	0.49	1.2	0.68	6.91
74500 / 74856	157	143	196	210	3.5	3.3	48.4	0.49	1.2	0.68	7.06
HM926747 / HM926710	158	139	201	223	3.5	3.3	67.7	0.74	0.81	0.45	8.59
97500 / 97900	157	137	198	219	3.5	3.3	67.5	0.74	0.82	0.45	8.59
95500 / 95925	160	142	210	224	6.4	3.3	49.4	0.37	1.6	0.89	11.8
95502 / 95925	166	143	210	224	9.7	3.3	49.5	0.37	1.6	0.89	12

Note ▲ The tolerances are listed in tables 2 to 4 on page B 99.

SINGLE-ROW TAPERED ROLLER BEARINGS (INCH DESIGN)

Bore Diameter 127.000 – 130.175 mm

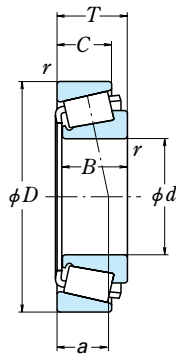

<i>d</i>	Boundary Dimensions (mm/inch)					Basic Load Ratings (kN) (kgf)				
	<i>D</i>	<i>T</i>	<i>B</i>	<i>C</i>	CONE <i>r</i> min.	CUP	<i>C_r</i>	<i>C_{0r}</i>	<i>C_r</i>	<i>C_{0r}</i>
127.000 5.0000	247.650 9.7500	63.500 2.5000	63.500 2.5000	47.625 1.8750	3.3	4.8	465	640	47 500	65 000
	247.650 9.7500	63.500 2.5000	63.500 2.5000	49.212 1.9375	6.4	3.3	510	790	52 000	80 500
	254.000 10.0000	77.788 3.0625	82.550 3.2500	57.150 2.2500	9.7	6.4	570	800	58 000	82 000
	254.000 10.0000	77.788 3.0625	82.550 3.2500	61.913 2.4375	9.7	6.4	675	975	69 000	99 500
	288.925 11.3750	82.550 3.2500	87.312 3.4375	57.150 2.2500	13.5	6.4	770	1 010	78 500	103 000
	295.275 11.6250	82.550 3.2500	87.312 3.4375	57.150 2.2500	13.5	6.4	770	1 010	78 500	103 000
	304.800 12.0000	60.325 2.3750	61.912 2.4375	41.275 1.6250	6.4	6.4	635	780	64 500	79 500
304.800 12.0000	88.900 3.5000	82.550 3.2500	57.150 2.2500	6.4	6.4	745	1 010	76 000	103 000	
127.792 5.0312	228.600 9.0000	53.975 2.1250	49.428 1.9460	38.100 1.5000	3.5	3.3	375	530	38 000	54 000
128.588 5.0625	190.500 7.5000	34.925 1.3750	31.750 1.2500	25.400 1.0000	3.5	3.3	176	325	17 900	33 000
	206.375 8.1250	47.625 1.8750	47.625 1.8750	34.925 1.3750	3.3	3.3	320	530	32 500	54 000
130.000 5.1181	206.375 8.1250	47.625 1.8750	47.625 1.8750	34.925 1.3750	3.5	3.3	320	530	32 500	54 000
	130.175 5.1250	196.850 7.7500	46.038 1.8125	46.038 1.8125	38.100 1.5000	3.5	3.3	315	560	32 000
203.200 8.0000		46.038 1.8125	46.038 1.8125	38.100 1.5000	3.5	3.3	315	560	32 000	57 500
206.375 8.1250		47.625 1.8750	47.625 1.8750	34.925 1.3750	3.5	3.3	320	530	32 500	54 000

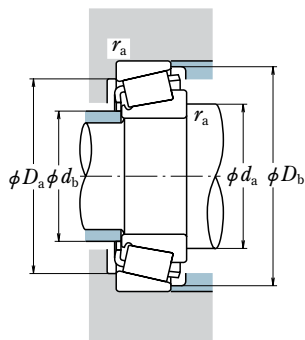

Dynamic Equivalent Load

$$P = XF_r + YF_a$$

$F_a/F_r \leq e$		$F_a/F_r > e$	
X	Y	X	Y
1	0	0.4	Y_1

Static Equivalent Load

$$P_0 = 0.5F_r + Y_0F_a$$

When $F_r > 0.5F_r + Y_0F_a$, use $P_0 = F_r$

The values of e , Y_1 , and Y_0 are given in the table below.

Bearing Numbers	Abutment and Fillet Dimensions (mm)						Eff. Load Centers (mm) a	Constant e	Axial Load Factors		Mass (kg) approx.
	d_a	d_b	D_a	D_b	CONE r_a max.	CUP r_a			Y_1	Y_0	
EE116050 / 116097	158	143	219	234	3.3	4.8	50.1	0.37	1.6	0.90	12.6
95500 / 95975	163	143	218	233	6.4	3.3	50.5	0.37	1.6	0.89	13.5
EE153050 / 153100	167	144	223	240	9.7	6.4	53.7	0.32	1.9	1.0	16.6
HH228349 / HH228310	166	143	223	242	9.7	6.4	55.0	0.34	1.8	0.97	17.6
HH231637 / HH231610	179	151	258	275	13.5	6.4	56.3	0.32	1.9	1.0	24.3
HH231637 / HH231615	179	151	261	278	13.5	6.4	56.3	0.32	1.9	1.0	25.6
EE750502 / 751200	174	158	271	285	6.4	6.4	49.2	0.33	1.8	0.99	21.4
HH932132 / HH932110	185	154	262	295	6.4	6.4	92.3	0.73	0.82	0.45	29.6
HM926749 / HM926710	158	139	201	223	3.5	3.3	67.7	0.74	0.81	0.45	8.53
48506 / 48750	150	137	171	184	3.5	3.3	50.3	0.65	0.92	0.51	3.24
799 / 792	153	138	186	199	3.3	3.3	45.7	0.46	1.3	0.72	5.77
797 / 792	153	139	186	199	3.5	3.3	45.7	0.46	1.3	0.72	5.66
67389 / 67322	152	140	180	192	3.5	3.3	39.7	0.34	1.7	0.96	4.97
67389 / 67320	152	140	183	195	3.5	3.3	39.7	0.34	1.7	0.96	5.57
799A / 792	154	139	186	199	3.5	3.3	45.7	0.46	1.3	0.72	5.65

SINGLE-ROW TAPERED ROLLER BEARINGS (INCH DESIGN)

Bore Diameter 133.350 mm

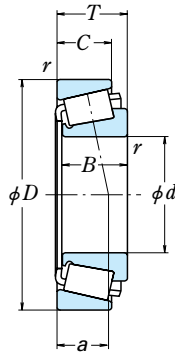

<i>d</i>	Boundary Dimensions (mm/inch)				CONE <i>r</i> CUP		Basic Load Ratings			
	<i>D</i>	<i>T</i>	<i>B</i>	<i>C</i>	min.		(kN) <i>C_r</i>	<i>C_{0r}</i>	(kgf) <i>C_r</i>	<i>C_{0r}</i>
133.350 5.2500	177.008	25.400	26.195	20.638	1.5	1.5	124	258	12 700	26 300
	6.9688	1.0000	1.0313	0.8125						
	190.500	39.688	39.688	33.338	3.5	3.3	240	485	24 500	49 500
	7.5000	1.5625	1.5625	1.3125						
	196.850	46.038	46.038	38.100	3.5	3.3	315	560	32 000	57 500
	7.7500	1.8125	1.8125	1.5000						
	196.850	46.038	46.038	38.100	8.0	3.3	315	560	32 000	57 500
	7.7500	1.8125	1.8125	1.5000						
	203.200	39.688	39.688	33.338	3.5	3.3	240	485	24 500	49 500
	8.0000	1.5625	1.5625	1.3125						
	203.200	46.038	46.038	38.100	3.5	3.3	315	560	32 000	57 500
	8.0000	1.8125	1.8125	1.5000						
	203.200	46.038	46.038	38.100	8.0	3.3	315	560	32 000	57 500
	8.0000	1.8125	1.8125	1.5000						
	215.000	47.625	47.625	34.925	3.5	3.3	287	495	29 300	50 000
	8.4646	1.8750	1.8750	1.3750						
	215.900	47.625	47.625	34.925	3.5	3.3	287	495	29 300	50 000
	8.5000	1.8750	1.8750	1.3750						
	217.488	47.625	47.625	34.925	3.5	3.3	287	495	29 300	50 000
	8.5625	1.8750	1.8750	1.3750						
	234.950	63.500	63.500	49.212	9.7	3.3	510	790	52 000	80 500
	9.2500	2.5000	2.5000	1.9375						
	234.950	63.500	63.500	49.212	4.8	3.3	510	790	52 000	80 500
	9.2500	2.5000	2.5000	1.9375						
	234.975	63.500	63.500	49.212	9.7	3.3	510	790	52 000	80 500
	9.2510	2.5000	2.5000	1.9375						
	234.975	63.500	63.500	49.212	4.8	3.3	510	790	52 000	80 500
	9.2510	2.5000	2.5000	1.9375						
	247.650	63.500	63.500	49.212	9.7	3.3	510	790	52 000	80 500
	9.7500	2.5000	2.5000	1.9375						
	247.650	63.500	63.500	49.212	4.8	3.3	510	790	52 000	80 500
	9.7500	2.5000	2.5000	1.9375						

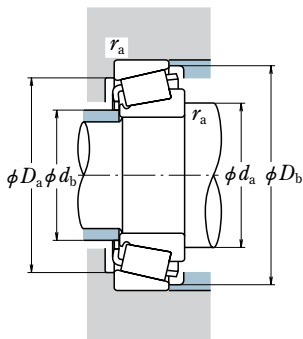

Dynamic Equivalent Load

$$P = XF_r + YF_a$$

$F_a/F_r \leq e$		$F_a/F_r > e$	
X	Y	X	Y
1	0	0.4	Y_1

Static Equivalent Load

$$P_0 = 0.5F_r + Y_0F_a$$

When $F_r > 0.5F_r + Y_0F_a$, use $P_0 = F_r$

The values of e , Y_1 , and Y_0 are given in the table below.

Bearing Numbers	Abutment and Fillet Dimensions (mm)						Eff. Load Centers (mm) \bar{a}	Constant e	Axial Load Factors		Mass (kg) approx.
	d_a	d_b	D_a	D_b	CONE r_a max.	CUP			Y_1	Y_0	
L327249 / L327210	147	141	166	172	1.5	1.5	29.5	0.35	1.7	0.95	1.73
48385 / 48320	153	142	175	185	3.5	3.3	35.9	0.32	1.9	1.0	3.74
67390 / 67322	153	142	180	192	3.5	3.3	39.7	0.34	1.7	0.96	4.74
67391 / 67322	158	142	180	192	8.0	3.3	39.7	0.34	1.7	0.96	4.7
48385 / 48328	153	142	182	191	3.5	3.3	35.9	0.32	1.9	1.0	4.76
67390 / 67320	153	142	183	195	3.5	3.3	39.7	0.34	1.7	0.96	5.33
67391 / 67320	158	142	183	195	8.0	3.3	39.7	0.34	1.7	0.96	5.29
74525 / 74846X	160	147	195	208	3.5	3.3	48.4	0.49	1.2	0.68	6.34
74525 / 74850	160	147	195	209	3.5	3.3	48.4	0.49	1.2	0.68	6.42
74525 / 74856	160	147	196	210	3.5	3.3	48.4	0.49	1.2	0.68	6.57
95525 / 95925	169	146	212	226	9.7	3.3	50.5	0.37	1.6	0.89	11
95528 / 95925	164	146	212	226	4.8	3.3	50.5	0.37	1.6	0.89	11
95525 / 95928	169	146	212	227	9.7	3.3	50.5	0.37	1.6	0.89	11
95528 / 95928	164	146	212	227	4.8	3.3	50.5	0.37	1.6	0.89	11
95525 / 95975	169	146	218	233	9.7	3.3	50.5	0.37	1.6	0.89	12.8
95528 / 95975	164	146	218	233	4.8	3.3	50.5	0.37	1.6	0.89	12.9

SINGLE-ROW TAPERED ROLLER BEARINGS (INCH DESIGN)

Bore Diameter 136.525 – 139.700 mm

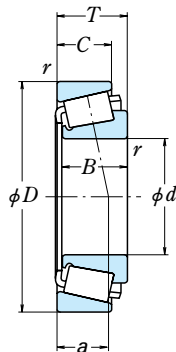

<i>d</i>	Boundary Dimensions (mm/inch)					Basic Load Ratings (kN) (kgf)					
	<i>D</i>	<i>T</i>	<i>B</i>	<i>C</i>	CONE <i>r</i> CUP min.		<i>C_r</i>	<i>C_{0r}</i>	<i>C_r</i>	<i>C_{0r}</i>	
136.525 5.3750	190.500 7.5000	39.688 1.5625	39.688 1.5625	33.338 1.3125	3.5	3.3	240	485	24 500	49 500	
	215.000 8.4646	47.625 1.8750	47.625 1.8750	34.925 1.3750	3.5	3.3	287	495	29 300	50 000	
	215.900 8.5000	47.625 1.8750	47.625 1.8750	34.925 1.3750	3.5	3.3	287	495	29 300	50 000	
	217.488 8.5625	47.625 1.8750	47.625 1.8750	34.925 1.3750	3.5	3.3	287	495	29 300	50 000	
	228.600 9.0000	57.150 2.2500	57.150 2.2500	44.450 1.7500	3.5	3.3	380	620	38 500	63 500	
	254.000 10.0000	66.675 2.6250	66.675 2.6250	47.625 1.8750	7.0	3.3	515	830	52 500	84 500	
	139.700 5.5000	180.975 7.1250	21.433 0.8438	20.638 0.8125	16.670 0.6563	1.5	1.5	104	194	10 600	19 700
		187.325 7.3750	28.575 1.1250	29.370 1.1563	23.020 0.9063	1.5	1.5	153	305	15 600	31 500
		215.000 8.4646	47.625 1.8750	47.625 1.8750	34.925 1.3750	3.5	3.3	287	495	29 300	50 000
		215.000 8.4646	47.625 1.8750	47.625 1.8750	34.925 1.3750	6.4	3.3	287	495	29 300	50 000
215.900 8.5000		47.625 1.8750	47.625 1.8750	34.925 1.3750	3.5	3.3	287	495	29 300	50 000	
222.250 8.7500		34.925 1.3750	31.623 1.2450	23.812 0.9375	3.5	3.3	191	267	19 500	27 200	
228.600 9.0000		57.150 2.2500	57.150 2.2500	44.450 1.7500	3.5	3.3	380	620	38 500	63 500	
228.600 9.0000		57.150 2.2500	57.150 2.2500	44.450 1.7500	6.4	3.3	380	620	38 500	63 500	
236.538 9.3125		57.150 2.2500	56.642 2.2300	44.450 1.7500	3.5	3.3	455	720	46 000	73 500	
236.538 9.3125		57.150 2.2500	56.642 2.2300	44.450 1.7500	3.5	3.3	400	680	41 000	69 500	

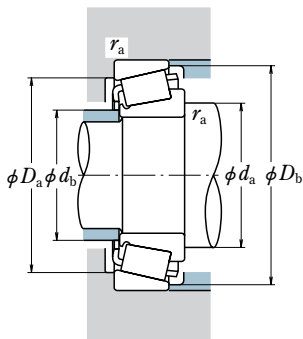

Dynamic Equivalent Load

$$P = XF_r + YF_a$$

$F_a/F_r \leq e$		$F_a/F_r > e$	
X	Y	X	Y
1	0	0.4	Y_1

Static Equivalent Load

$$P_0 = 0.5F_r + Y_0F_a$$

When $F_r > 0.5F_r + Y_0F_a$, use $P_0 = F_r$

The values of e , Y_1 , and Y_0 are given in the table below.

Bearing Numbers	Abutment and Fillet Dimensions (mm)						Eff. Load Centers (mm) \bar{a}	Constant e	Axial Load Factors		Mass (kg)
	d_a	d_b	D_a	D_b	CONE r_a max.	CUP			Y_1	Y_0	
48393 / 48320	154	144	175	185	3.5	3.3	35.9	0.32	1.9	1.0	3.53
74537 / 74846X	162	148	195	208	3.5	3.3	48.4	0.49	1.2	0.68	6.09
74537 / 74850	162	148	195	209	3.5	3.3	48.4	0.49	1.2	0.68	6.17
74537 / 74856	162	148	196	210	3.5	3.3	48.4	0.49	1.2	0.68	6.32
896 / 892	163	149	204	219	3.5	3.3	51.5	0.42	1.4	0.78	8.86
99537 / 99100	178	157	230	245	7.0	3.3	55.3	0.41	1.5	0.81	14.2
LL428349 / LL428310	152	147	171	176	1.5	1.5	29.8	0.37	1.6	0.90	1.36
LM328448 / LM328410	155	148	176	182	1.5	1.5	31.7	0.36	1.7	0.93	2.26
74550 / 74846X	163	150	195	208	3.5	3.3	48.4	0.49	1.2	0.68	5.83
74550A / 74846X	166	150	195	208	6.4	3.3	48.4	0.49	1.2	0.68	5.81
74550 / 74850	163	150	195	209	3.5	3.3	48.4	0.49	1.2	0.68	5.92
73551 / 73875	162	152	203	211	3.5	3.3	41.6	0.44	1.4	0.75	4.25
898 / 892	165	151	204	219	3.5	3.3	51.5	0.42	1.4	0.78	8.55
898A / 892	168	151	204	219	6.4	3.3	51.5	0.42	1.4	0.78	8.53
HM231132 / HM231110	168	154	216	228	3.5	3.3	45.9	0.32	1.9	1.0	9.63
82550 / 82931	170	155	213	228	3.5	3.3	53.7	0.44	1.4	0.75	9.81

SINGLE-ROW TAPERED ROLLER BEARINGS (INCH DESIGN)

Bore Diameter 139.700 – 142.875 mm

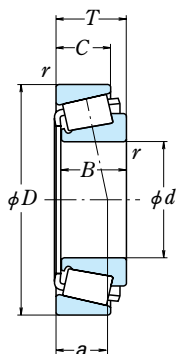

<i>d</i>	Boundary Dimensions (mm/inch)					Basic Load Ratings (kN) (kgf)					
	<i>D</i>	<i>T</i>	<i>B</i>	<i>C</i>	CONE <i>r</i> min.	CUP	<i>C_r</i>	<i>C_{0r}</i>	<i>C_r</i>	<i>C_{0r}</i>	
139.700 5.5000	241.300	57.150	56.642	44.450	3.5	3.3	455	720	46 000	73 500	
	9.5000	2.2500	2.2300	1.7500							
	241.300	57.150	56.642	44.450	3.5	3.3	400	680	41 000	69 500	
	9.5000	2.2500	2.2300	1.7500							
	250.000	66.675	66.675	47.625	7.0	3.3	515	830	52 500	84 500	
	9.8425	2.6250	2.6250	1.8750							
	254.000	66.675	66.675	47.625	7.0	3.3	515	830	52 500	84 500	
	10.0000	2.6250	2.6250	1.8750							
	288.925	82.550	87.312	57.150	9.7	6.4	770	1 010	78 500	103 000	
	11.3750	3.2500	3.4375	2.2500							
	295.275	82.550	87.312	57.150	9.7	6.4	770	1 010	78 500	103 000	
	11.6250	3.2500	3.4375	2.2500							
140.000 5.5118	307.975	88.900	93.662	66.675	9.7	6.8	885	1 190	90 000	121 000	
	12.1250	3.5000	3.6875	2.6250							
	317.500	88.900	93.662	66.675	9.7	6.8	885	1 190	90 000	121 000	
	12.5000	3.5000	3.6875	2.6250							
	215.000	47.625	47.625	34.925	3.5	3.3	287	495	29 300	50 000	
	8.4646	1.8750	1.8750	1.3750							
	215.900	47.625	47.625	34.925	3.5	3.3	287	495	29 300	50 000	
	8.5000	1.8750	1.8750	1.3750							
	217.488	47.625	47.625	34.925	3.5	3.3	287	495	29 300	50 000	
	8.5625	1.8750	1.8750	1.3750							
	142.875 5.6250	200.025	41.275	39.688	34.130	8.0	3.3	227	460	23 100	46 500
		7.8750	1.6250	1.5625	1.3437						
200.025		41.275	39.688	34.130	3.5	3.3	227	460	23 100	46 500	
7.8750		1.6250	1.5625	1.3437							
236.538		57.150	56.642	44.450	3.5	3.3	455	720	46 000	73 500	
9.3125		2.2500	2.2300	1.7500							
236.538		57.150	56.642	44.450	3.5	3.3	400	680	41 000	69 500	
9.3125		2.2500	2.2300	1.7500							
241.300	57.150	56.642	44.450	3.5	3.3	455	720	46 000	73 500		
9.5000	2.2500	2.2300	1.7500								

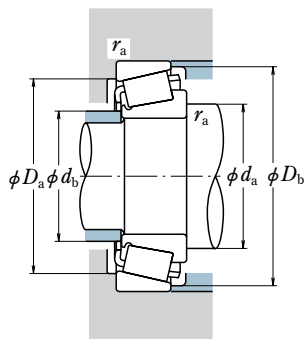

Dynamic Equivalent Load

$$P = XF_r + YF_a$$

$F_a/F_r \leq e$		$F_a/F_r > e$	
X	Y	X	Y
1	0	0.4	Y_1

Static Equivalent Load

$$P_0 = 0.5F_r + Y_0F_a$$

When $F_r > 0.5F_r + Y_0F_a$, use $P_0 = F_r$

The values of e , Y_1 , and Y_0 are given in the table below.

Bearing Numbers	Abutment and Fillet Dimensions (mm)						Eff. Load Centers (mm) \bar{a}	Constant e	Axial Load Factors		Mass (kg) approx.
	d_a	d_b	D_a	D_b	CONE r_a max.	CUP r_a			Y_1	Y_0	
HM231132 / HM231115	168	154	218	230	3.5	3.3	45.9	0.32	1.9	1.0	10.3
82550 / 82950	170	155	215	230	3.5	3.3	53.7	0.44	1.4	0.75	10.4
99550 / 99098X	179	158	228	243	7.0	3.3	55.3	0.41	1.5	0.81	13.2
99550 / 99100	179	158	230	245	7.0	3.3	55.3	0.41	1.5	0.81	13.8
HH231649 / HH231610	182	158	258	275	9.7	6.4	56.3	0.32	1.9	1.0	22.6
HH231649 / HH231615	182	158	261	278	9.7	6.4	56.3	0.32	1.9	1.0	23.9
HH234031 / HH234010	191	165	275	294	9.7	6.8	63.2	0.33	1.8	1.0	29.8
HH234031 / HH234018	191	165	279	298	9.7	6.8	63.2	0.33	1.8	1.0	32.2
74551X / 74846X	163	150	195	208	3.5	3.3	48.4	0.49	1.2	0.68	5.81
74551X / 74850	163	150	195	209	3.5	3.3	48.4	0.49	1.2	0.68	5.89
74551X / 74856	163	150	196	210	3.5	3.3	48.4	0.49	1.2	0.68	6.04
48684 / 48620	167	153	185	195	8.0	3.3	37.6	0.34	1.8	0.98	3.77
48685 / 48620	162	153	185	195	3.5	3.3	37.6	0.34	1.8	0.98	3.81
HM231136 / HM231110	170	156	216	228	3.5	3.3	45.9	0.32	1.9	1.0	9.32
82562 / 82931	171	156	213	228	3.5	3.3	53.7	0.44	1.4	0.75	9.5
HM231136 / HM231115	170	156	218	230	3.5	3.3	45.9	0.32	1.9	1.0	9.94

SINGLE-ROW TAPERED ROLLER BEARINGS (INCH DESIGN)

Bore Diameter 142.875 – 146.050 mm

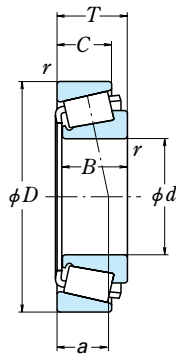

<i>d</i>	Boundary Dimensions (mm/inch)				CONE r CUP		Basic Load Ratings			
	<i>D</i>	<i>T</i>	<i>B</i>	<i>C</i>	min.		(kN) <i>C_r</i>	<i>C_{0r}</i>	(kgf) <i>C_r</i>	<i>C_{0r}</i>
142.875 5.6250	241.300 9.5000	57.150 2.2500	56.642 2.2300	44.450 1.7500	3.5	3.3	400	680	41 000	69 500
146.050 5.7500	188.120 7.4063	22.225 0.8750	20.638 0.8125	16.670 0.6563	1.5	1.5	107	200	10 900	20 400
	193.675 7.6250	28.575 1.1250	28.575 1.1250	23.020 0.9063	1.5	1.5	170	355	17 300	36 500
	193.675 7.6250	28.575 1.1250	28.575 1.1250	23.020 0.9063	4.8	1.5	170	355	17 300	36 500
	236.538 9.3125	57.150 2.2500	56.642 2.2300	44.450 1.7500	3.5	3.3	455	720	46 000	73 500
	236.538 9.3125	57.150 2.2500	56.642 2.2300	44.450 1.7500	3.5	3.3	400	680	41 000	69 500
	241.300 9.5000	57.150 2.2500	56.642 2.2300	44.450 1.7500	3.5	3.3	455	720	46 000	73 500
	241.300 9.5000	57.150 2.2500	56.642 2.2300	44.450 1.7500	3.5	3.3	400	680	41 000	69 500
	244.475 9.6250	47.625 1.8750	50.005 1.9687	33.338 1.3125	3.5	3.3	330	510	34 000	52 000
	254.000 10.0000	66.675 2.6250	66.675 2.6250	47.625 1.8750	7.0	3.3	515	830	52 500	84 500
	268.288 10.5625	74.612 2.9375	74.612 2.9375	57.150 2.2500	6.4	6.4	610	980	62 000	100 000
	304.800 12.0000	88.900 3.5000	82.550 3.2500	57.150 2.2500	6.4	6.4	745	1 010	76 000	103 000
	307.975 12.1250	88.900 3.5000	93.662 3.6875	61.912 2.4375	9.7	6.8	745	1 070	76 000	109 000
	307.975 12.1250	88.900 3.5000	93.662 3.6875	66.675 2.6250	9.7	6.8	885	1 190	90 000	121 000
	311.150 12.2500	88.900 3.5000	82.550 3.2500	57.150 2.2500	6.4	6.4	745	1 010	76 000	103 000
	317.500 12.5000	88.900 3.5000	93.662 3.6875	66.675 2.6250	9.7	6.8	885	1 190	90 000	121 000

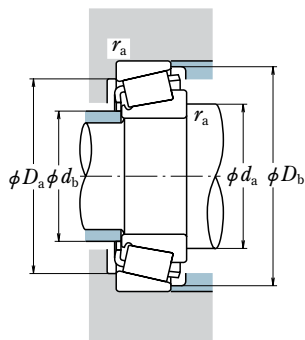

Dynamic Equivalent Load

$$P = XF_r + YF_a$$

$F_a/F_r \leq e$		$F_a/F_r > e$	
X	Y	X	Y
1	0	0.4	Y_1

Static Equivalent Load

$$P_0 = 0.5F_r + Y_0F_a$$

When $F_r > 0.5F_r + Y_0F_a$, use $P_0 = F_r$

The values of e , Y_1 , and Y_0 are given in the table below.

Bearing Numbers	Abutment and Fillet Dimensions (mm)						Eff. Load Centers (mm) \bar{a}	Constant e	Axial Load Factors		Mass (kg) approx.
	d_a	d_b	D_a	D_b	CONE r_a max.	CUP r_a			Y_1	Y_0	
82562 / 82950	171	156	215	230	3.5	3.3	53.7	0.44	1.4	0.75	10.1
LL529749 / LL529710	159	153	178	183	1.5	1.5	33.5	0.42	1.4	0.79	1.44
36690 / 36620	161	154	182	188	1.5	1.5	33.5	0.37	1.6	0.90	2.36
36691 / 36620	164	154	182	188	4.8	1.5	33.5	0.37	1.6	0.90	2.35
HM231140 / HM231110	171	158	216	228	3.5	3.3	45.9	0.32	1.9	1.0	9.0
82576 / 82931	173	158	213	228	3.5	3.3	53.7	0.44	1.4	0.75	9.18
HM231140 / HM231115	171	158	218	230	3.5	3.3	45.9	0.32	1.9	1.0	9.62
82576 / 82950	173	158	215	230	3.5	3.3	53.7	0.44	1.4	0.75	9.8
81575 / 81962	175	164	225	235	3.5	3.3	42.9	0.35	1.7	0.94	8.28
99575 / 99100	182	162	230	245	7.0	3.3	55.3	0.41	1.5	0.81	13.1
EE107057 / 107105	184	163	236	256	6.4	6.4	59.5	0.39	1.5	0.85	17.6
HH932145 / HH932110	195	164	262	295	6.4	6.4	92.3	0.73	0.82	0.45	27
EE450577 / 451212	196	171	271	289	9.7	6.8	61.5	0.33	1.8	1.0	28.8
HH234040 / HH234010	194	168	275	294	9.7	6.8	63.2	0.33	1.8	1.0	28.7
HH932145 / HH932115	195	164	265	298	6.4	6.4	92.3	0.73	0.82	0.45	28.3
HH234040 / HH234018	194	168	279	298	9.7	6.8	63.2	0.33	1.8	1.0	31.2

SINGLE-ROW TAPERED ROLLER BEARINGS (INCH DESIGN)

Bore Diameter 149.225 – 153.988 mm

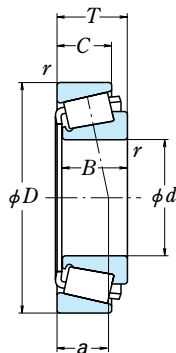

<i>d</i>	Boundary Dimensions (mm/inch)					Basic Load Ratings (kN) (kgf)					
	<i>D</i>	<i>T</i>	<i>B</i>	<i>C</i>	CONE <i>r</i> min.	CUP	<i>C_r</i>	<i>C_{0r}</i>	<i>C_r</i>	<i>C_{0r}</i>	
149.225 5.8750	236.538 9.3125	57.150 2.2500	56.642 2.2300	44.450 1.7500	6.4	3.3	455	720	46 000	73 500	
	236.538 9.3125	57.150 2.2500	56.642 2.2300	44.450 1.7500	3.5	3.3	455	720	46 000	73 500	
	236.538 9.3125	57.150 2.2500	56.642 2.2300	44.450 1.7500	3.5	3.3	400	680	41 000	69 500	
	241.300 9.5000	57.150 2.2500	56.642 2.2300	44.450 1.7500	6.4	3.3	455	720	46 000	73 500	
	241.300 9.5000	57.150 2.2500	56.642 2.2300	44.450 1.7500	3.5	3.3	455	720	46 000	73 500	
	241.300 9.5000	57.150 2.2500	56.642 2.2300	44.450 1.7500	3.5	3.3	400	680	41 000	69 500	
	150.000 5.9055	244.475 9.6250	47.625 1.8750	50.005 1.9687	33.338 1.3125	3.5	3.3	330	510	34 000	52 000
		152.400 6.0000	222.250 8.7500	46.830 1.8437	46.830 1.8437	34.925 1.3750	3.5	1.5	287	530	29 200
	244.475 9.6250		47.625 1.8750	50.005 1.9687	33.338 1.3125	3.5	3.3	330	510	34 000	52 000
	254.000 10.0000		66.675 2.6250	66.675 2.6250	47.625 1.8750	7.0	3.3	515	830	52 500	84 500
268.288 10.5625	74.612 2.9375		74.612 2.9375	57.150 2.2500	6.4	6.4	610	980	62 000	100 000	
307.975 12.1250	88.900 3.5000		93.662 3.6875	61.912 2.4375	9.7	6.8	745	1 070	76 000	109 000	
307.975 12.1250	88.900 3.5000		93.662 3.6875	66.675 2.6250	9.7	6.8	885	1 190	90 000	121 000	
317.500 12.5000	88.900 3.5000		93.662 3.6875	66.675 2.6250	9.7	6.8	885	1 190	90 000	121 000	
153.988 6.0625	244.475 9.6250		47.625 1.8750	50.005 1.9687	33.338 1.3125	3.5	3.3	330	510	34 000	52 000

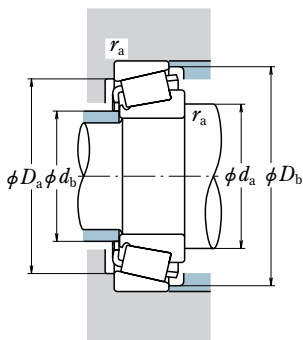

Dynamic Equivalent Load

$$P = XF_r + YF_a$$

$F_a/F_r \leq e$		$F_a/F_r > e$	
X	Y	X	Y
1	0	0.4	Y_1

Static Equivalent Load

$$P_0 = 0.5F_r + Y_0F_a$$

When $F_r > 0.5F_r + Y_0F_a$, use $P_0 = F_r$

The values of e , Y_1 , and Y_0 are given in the table below.

Bearing Numbers	Abutment and Fillet Dimensions (mm)						Eff. Load Centers (mm) \bar{a}	Constant e	Axial Load Factors		Mass (kg) approx.
	d_a	d_b	D_a	D_b	CONE r_a max.	CUP			Y_1	Y_0	
HM231148 / HM231110	176	159	216	228	6.4	3.3	45.9	0.32	1.9	1.0	8.65
HM231149 / HM231110	173	159	216	228	3.5	3.3	45.9	0.32	1.9	1.0	8.68
82587 / 82931	175	160	213	228	3.5	3.3	53.7	0.44	1.4	0.75	8.85
HM231148 / HM231115	176	159	218	230	6.4	3.3	45.9	0.32	1.9	1.0	9.27
HM231149 / HM231115	173	159	218	230	3.5	3.3	45.9	0.32	1.9	1.0	9.3
82587 / 82950	175	160	215	230	3.5	3.3	53.7	0.44	1.4	0.75	9.47
81590 / 81962	177	166	225	235	3.5	3.3	42.9	0.35	1.7	0.94	7.92
M231649 / M231610	175	163	207	215	3.5	1.5	41.6	0.33	1.8	0.99	5.76
81600 / 81962	178	167	225	235	3.5	3.3	42.9	0.35	1.7	0.94	7.7
99600 / 99100	185	165	230	245	7.0	3.3	55.3	0.41	1.5	0.81	12.3
EE107060 / 107105	187	166	236	256	6.4	6.4	59.5	0.39	1.5	0.85	16.7
EE450601 / 451212	199	174	271	289	9.7	6.8	61.5	0.33	1.8	1.0	27.7
HH234048 / HH234010	197	171	275	294	9.7	6.8	63.2	0.33	1.8	1.0	27.6
HH234048 / HH234018	197	171	279	298	9.7	6.8	63.2	0.33	1.8	1.0	30.1
81606 / 81962	179	168	225	235	3.5	3.3	42.9	0.35	1.7	0.94	7.55

SINGLE-ROW TAPERED ROLLER BEARINGS (INCH DESIGN)

Bore Diameter 155.575 – 165.100 mm

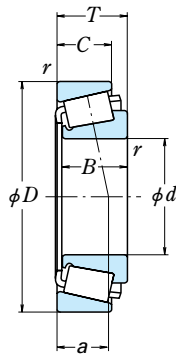

<i>d</i>	Boundary Dimensions (mm/inch)					Basic Load Ratings (kN) (kgf)				
	<i>D</i>	<i>T</i>	<i>B</i>	<i>C</i>	<i>r</i> CONE min.	CUP	<i>C_r</i>	<i>C_{0r}</i>	<i>C_r</i>	<i>C_{0r}</i>
155.575 6.1250	330.200	85.725	79.375	53.975	6.4	6.4	760	1 060	77 500	108 000
	13.0000	3.3750	3.1250	2.1250						
158.750 6.2500	342.900	85.725	79.375	53.975	6.4	6.4	760	1 060	77 500	108 000
	13.5000	3.3750	3.1250	2.1250						
159.951 6.2973	205.583	23.812	23.812	18.258	1.5	1.5	127	249	12 900	25 400
	8.0938	0.9375	0.9375	0.7188						
160.325 6.3120	225.425	41.275	39.688	33.338	3.5	3.3	240	540	24 400	55 000
	8.8750	1.6250	1.5625	1.3125						
161.925 6.3750	244.475	47.625	46.830	33.338	3.5	3.3	330	510	34 000	52 000
	9.6250	1.8750	1.8437	1.3125						
165.100 6.5000	374.650	87.312	79.375	60.325	6.4	3.3	855	1 090	87 000	111 000
	14.7500	3.4375	3.1250	2.3750						
	215.900	26.195	26.195	20.638	1.5	1.5	154	295	15 700	30 000
	8.5000	1.0313	1.0313	0.8125						
	225.425	41.275	39.688	33.338	3.5	3.3	240	540	24 400	55 000
	8.8750	1.6250	1.5625	1.3125						
	247.650	47.625	47.625	38.100	3.5	3.3	345	705	35 500	71 500
	9.7500	1.8750	1.8750	1.5000						
	254.000	46.038	46.038	33.338	4.8	3.3	370	595	37 500	61 000
	10.0000	1.8125	1.8125	1.3125						
	254.000	46.038	46.038	33.338	4.8	3.3	340	535	34 500	54 500
	10.0000	1.8125	1.8125	1.3125						
	288.925	63.500	63.500	47.625	7.0	3.3	615	935	62 500	95 500
	11.3750	2.5000	2.5000	1.8750						
	288.925	63.500	63.500	47.625	7.0	3.3	545	940	55 500	96 000
	11.3750	2.5000	2.5000	1.8750						
	298.450	63.500	63.500	47.625	7.0	3.3	545	940	55 500	96 000
	11.7500	2.5000	2.5000	1.8750						

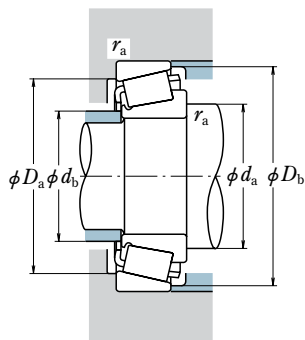

Dynamic Equivalent Load

$$P = XF_r + YF_a$$

$F_a/F_r \leq e$		$F_a/F_r > e$	
X	Y	X	Y
1	0	0.4	Y_1

Static Equivalent Load

$$P_0 = 0.5F_r + Y_0F_a$$

When $F_r > 0.5F_r + Y_0F_a$, use $P_0 = F_r$

The values of e , Y_1 , and Y_0 are given in the table below.

Bearing Numbers	Abutment and Fillet Dimensions (mm)						Eff. Load Centers (mm) \bar{a}	Constant e	Axial Load Factors		Mass (kg)
	d_a	d_b	D_a	D_b	CONE r_a max.	CUP			Y_1	Y_0	
H936340 / H936310	209	178	283	317	6.4	6.4	103.3	0.81	0.74	0.41	32.5
H936340 / H936316	209	178	289	323	6.4	6.4	103.3	0.81	0.74	0.41	35.3
L432349 / L432310	173	167	195	200	1.5	1.5	33.9	0.39	1.5	0.84	1.99
46780 / 46720	183	172	208	219	3.5	3.3	44.3	0.38	1.6	0.86	5.34
81629 / 81962	182	171	225	235	3.5	3.3	42.9	0.35	1.7	0.94	6.97
HM237532 / HM237510	202	183	266	278	7.0	3.3	52.7	0.32	1.9	1.0	17
81637 / 81962	183	172	225	235	3.5	3.3	42.9	0.35	1.7	0.94	6.67
EE117063 / 117148	217	188	325	355	6.4	3.3	98.6	0.71	0.85	0.47	42.2
L433749 / L433710	180	173	204	210	1.5	1.5	34.5	0.36	1.7	0.91	2.45
46790 / 46720	186	175	208	219	3.5	3.3	44.3	0.38	1.6	0.86	4.84
67780 / 67720	194	180	228	241	3.5	3.3	52.4	0.44	1.4	0.75	8.16
M235145 / M235113	191	178	235	245	4.8	3.3	41.9	0.32	1.9	1.0	7.72
86650 / 86100	191	178	235	246	4.8	3.3	44.9	0.37	1.6	0.89	7.56
HM237535 / HM237510	204	185	266	278	7.0	3.3	52.7	0.32	1.9	1.0	16.4
94649 / 94113	206	185	261	277	7.0	3.3	62.6	0.47	1.3	0.70	17.2
94649 / 94118	206	185	265	282	7.0	3.3	62.6	0.47	1.3	0.70	18.8

SINGLE-ROW TAPERED ROLLER BEARINGS (INCH DESIGN)

Bore Diameter 165.100 – 171.450 mm

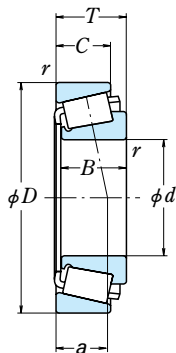

<i>d</i>	Boundary Dimensions (mm/inch)					Basic Load Ratings (kN) (kgf)				
	<i>D</i>	<i>T</i>	<i>B</i>	<i>C</i>	CONE <i>r</i> min.	CUP	<i>C_r</i>	<i>C_{0r}</i>	<i>C_r</i>	<i>C_{0r}</i>
165.100 6.5000	311.150 12.2500	82.550 3.2500	82.550 3.2500	63.500 2.5000	6.4	6.4	770	1 230	78 500	126 000
	311.150 12.2500	82.550 3.2500	82.550 3.2500	65.088 2.5625	6.4	6.4	835	1 280	85 000	131 000
	336.550 13.2500	92.075 3.6250	95.250 3.7500	69.850 2.7500	3.3	6.4	990	1 380	101 000	141 000
	360.000 14.1732	92.075 3.6250	88.897 3.4999	63.500 2.5000	9.7	3.3	875	1 340	89 000	137 000
	361.950 14.2500	106.362 4.1875	104.775 4.1250	76.200 3.0000	13.5	3.3	1 240	1 690	127 000	172 000
	166.688 6.5625	225.425 8.8750	41.275 1.6250	39.688 1.5625	33.338 1.3125	3.5	3.3	240	540	24 400
168.275 6.6250		247.650 9.7500	47.625 1.8750	47.625 1.8750	38.100 1.5000	3.5	3.3	345	705	35 500
	330.200 13.0000	85.725 3.3750	79.375 3.1250	53.975 2.1250	6.4	6.4	760	1 060	77 500	108 000
	342.900 13.5000	85.725 3.3750	79.375 3.1250	53.975 2.1250	6.4	6.4	760	1 060	77 500	108 000
	170.000 6.6929	230.000 9.0551	39.000 1.5354	38.000 1.4961	31.000 1.2205	3.0	2.5	278	520	28 300
240.000 9.4488		46.000 1.8110	44.500 1.7520	37.000 1.4567	3.0	2.5	380	720	39 000	73 000
254.000 10.0000		46.038 1.8125	46.038 1.8125	33.338 1.3125	4.8	3.3	370	595	37 500	61 000
254.000 10.0000		46.038 1.8125	46.038 1.8125	33.338 1.3125	4.8	3.3	340	535	34 500	54 500
171.450 6.7500	260.350 10.2500	66.675 2.6250	66.675 2.6250	52.388 2.0625	3.5	3.3	540	1 030	55 000	105 000
	288.925 11.3750	63.500 2.5000	63.500 2.5000	47.625 1.8750	7.0	3.3	545	940	55 500	96 000
	298.450 11.7500	63.500 2.5000	63.500 2.5000	47.625 1.8750	7.0	3.3	545	940	55 500	96 000

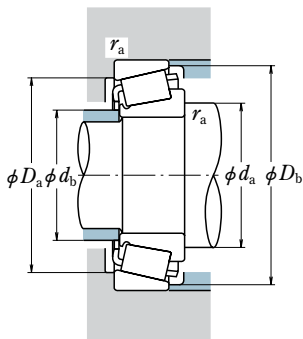

Dynamic Equivalent Load

$$P = XF_r + YF_a$$

$F_a/F_r \leq e$		$F_a/F_r > e$	
X	Y	X	Y
1	0	0.4	Y_1

Static Equivalent Load

$$P_0 = 0.5F_r + Y_0F_a$$

When $F_r > 0.5F_r + Y_0F_a$, use $P_0 = F_r$

The values of e , Y_1 , and Y_0 are given in the table below.

Bearing Numbers	Abutment and Fillet Dimensions (mm)						Eff. Load Centers (mm) \bar{a}	Constant e	Axial Load Factors		Mass (kg)
	d_a	d_b	D_a	D_b	CONE r_a max.	CUP r_a			Y_1	Y_0	
EE219065 / 219122	206	185	274	295	6.4	6.4	65.8	0.38	1.6	0.88	26.3
H238140 / H238110	208	187	279	298	6.4	6.4	63.9	0.33	1.8	1.0	26.5
HH437549 / HH437510	206	185	297	320	3.3	6.4	70.8	0.37	1.6	0.89	35
EE420651 / 421417	234	208	329	349	9.7	3.3	78.9	0.42	1.4	0.79	42.1
EE108065 / 108142	220	188	323	342	13.5	3.3	73.4	0.33	1.8	0.99	48.5
46792 / 46720	187	176	208	219	3.5	3.3	44.3	0.38	1.6	0.86	4.71
67782 / 67720	195	182	228	241	3.5	3.3	52.4	0.44	1.4	0.75	7.85
H936349 / H936310	216	184	283	317	6.4	6.4	103.3	0.81	0.74	0.41	30.5
H936349 / H936316	216	184	289	323	6.4	6.4	103.3	0.81	0.74	0.41	33.3
▲JHM534149 / JHM534110	188	177	215	225	3.0	2.5	43.2	0.38	1.6	0.86	4.41
▲JM734449 / JM734410	191	178	222	234	3.0	2.5	50.5	0.44	1.4	0.75	6.44
M235149 / M235113	194	180	235	245	4.8	3.3	41.9	0.32	1.9	1.0	7.26
86669 / 86100	194	181	235	246	4.8	3.3	44.9	0.37	1.6	0.89	7.09
HM535349 / HM535310	198	182	236	252	3.5	3.3	57.6	0.40	1.5	0.82	12.5
94675 / 94113	209	189	261	277	7.0	3.3	62.6	0.47	1.3	0.70	16.3
94675 / 94118	209	189	265	282	7.0	3.3	62.6	0.47	1.3	0.70	18

Note ▲ The tolerances are listed in tables 2 to 4 on page B 99.

SINGLE-ROW TAPERED ROLLER BEARINGS (INCH DESIGN)

Bore Diameter 174.625 – 177.800 mm

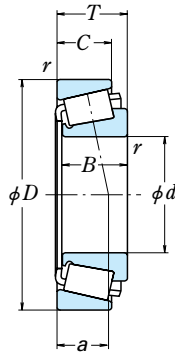

<i>d</i>	Boundary Dimensions (mm/inch)					Basic Load Ratings (kN) (kgf)					
	<i>D</i>	<i>T</i>	<i>B</i>	<i>C</i>	CONE <i>r</i> min.	CUP	<i>C_r</i>	<i>C_{0r}</i>	<i>C_r</i>	<i>C_{0r}</i>	
174.625 6.8750	247.650 9.7500	47.625 1.8750	47.625 1.8750	38.100 1.5000	3.5	3.3	345	705	35 500	71 500	
	288.925 11.3750	63.500 2.5000	63.500 2.5000	47.625 1.8750	7.0	3.3	615	935	62 500	95 500	
	288.925 11.3750	63.500 2.5000	63.500 2.5000	47.625 1.8750	7.0	3.3	545	940	55 500	96 000	
	298.450 11.7500	63.500 2.5000	63.500 2.5000	47.625 1.8750	7.0	3.3	545	940	55 500	96 000	
	298.450 11.7500	82.550 3.2500	82.550 3.2500	63.500 2.5000	6.4	6.4	795	1 290	81 000	131 000	
	311.150 12.2500	82.550 3.2500	82.550 3.2500	65.088 2.5625	6.4	6.4	835	1 280	85 000	131 000	
	177.800 7.0000	215.900 8.5000	20.638 0.8125	20.638 0.8125	15.083 0.5938	1.5	1.5	109	241	11 100	24 600
		227.012 8.9375	30.162 1.1875	30.162 1.1875	23.020 0.9063	1.5	1.5	181	415	18 500	42 000
		247.650 9.7500	47.625 1.8750	47.625 1.8750	38.100 1.5000	3.5	3.3	345	705	35 500	71 500
		247.650 9.7500	47.625 1.8750	47.625 1.8750	38.100 1.5000	10.4	3.3	345	705	35 500	71 500
260.350 10.2500		53.975 2.1250	53.975 2.1250	41.275 1.6250	3.5	3.3	455	835	46 500	85 000	
269.875 10.6250		55.562 2.1875	55.562 2.1875	42.862 1.6875	3.5	3.3	465	875	47 000	89 500	
285.750 11.2500		63.500 2.5000	63.500 2.5000	41.275 1.6250	6.4	3.3	450	725	46 000	74 000	
288.925 11.3750		63.500 2.5000	63.500 2.5000	47.625 1.8750	7.0	3.3	615	935	62 500	95 500	
288.925 11.3750		63.500 2.5000	63.500 2.5000	47.625 1.8750	7.0	3.3	545	940	55 500	96 000	
304.800 12.0000		66.675 2.6250	69.106 2.7207	42.862 1.6875	6.4	3.3	555	810	56 500	82 500	

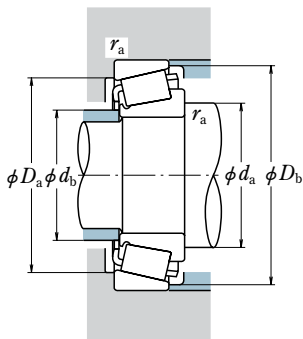

Dynamic Equivalent Load

$$P = XF_r + YF_a$$

$F_a/F_r \leq e$		$F_a/F_r > e$	
X	Y	X	Y
1	0	0.4	Y_1

Static Equivalent Load

$$P_0 = 0.5F_r + Y_0F_a$$

When $F_r > 0.5F_r + Y_0F_a$, use $P_0 = F_r$

The values of e , Y_1 , and Y_0 are given in the table below.

Bearing Numbers	Abutment and Fillet Dimensions (mm)						Eff. Load Centers (mm) \bar{a}	Constant e	Axial Load Factors		Mass (kg)
	d_a	d_b	D_a	D_b	CONE r_a max.	CUP			Y_1	Y_0	
67787 / 67720	199	185	228	241	3.5	3.3	52.4	0.44	1.4	0.75	7.21
HM237542 / HM237510	209	190	266	278	7.0	3.3	52.7	0.32	1.9	1.0	15.2
94687 / 94113	211	190	261	277	7.0	3.3	62.6	0.47	1.3	0.70	15.9
94687 / 94118	211	190	265	282	7.0	3.3	62.6	0.47	1.3	0.70	17.5
EE219068 / 219117	211	190	267	288	6.4	6.4	66.4	0.38	1.6	0.88	22.1
H238148 / H238110	212	191	279	298	6.4	6.4	63.9	0.33	1.8	1.0	24.9
LL735449 / LL735410	190	184	206	211	1.5	1.5	38.5	0.45	1.3	0.73	1.51
36990 / 36920	193	185	214	222	1.5	1.5	42.9	0.44	1.4	0.75	3.01
67790 / 67720	200	186	228	241	3.5	3.3	52.4	0.44	1.4	0.75	6.88
67791 / 67720	207	186	228	241	10.4	3.3	52.4	0.44	1.4	0.75	6.79
M236849 / M236810	201	189	241	252	3.5	3.3	47.5	0.33	1.8	0.99	9.35
M238840 / M238810	208	194	250	262	3.5	3.3	51.1	0.35	1.7	0.95	11.1
EE91702 / 91112	210	193	260	274	6.4	3.3	58.9	0.43	1.4	0.77	13.7
HM237545 / HM237510	210	191	266	278	7.0	3.3	52.7	0.32	1.9	1.0	14.7
94700 / 94113	213	192	261	277	7.0	3.3	62.6	0.47	1.3	0.70	15.5
EE280702 / 281200	214	196	280	292	6.4	3.3	54.3	0.36	1.7	0.92	17.4

SINGLE-ROW TAPERED ROLLER BEARINGS (INCH DESIGN)

Bore Diameter 177.800 – 187.325 mm

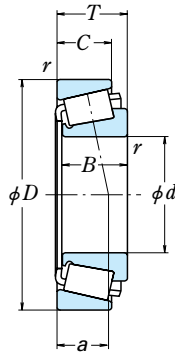

<i>d</i>	Boundary Dimensions (mm/inch)					Basic Load Ratings (kN) (kgf)					
	<i>D</i>	<i>T</i>	<i>B</i>	<i>C</i>	CONE <i>r</i> min.	CUP	<i>C_r</i>	<i>C_{0r}</i>	<i>C_r</i>	<i>C_{0r}</i>	
177.800 7.0000	319.964 12.5970	88.900 3.5000	85.725 3.3750	65.088 2.5625	3.5	4.8	790	1 300	80 500	133 000	
	319.964 12.5970	88.900 3.5000	85.725 3.3750	65.088 2.5625	3.5	4.8	855	1 270	87 500	129 000	
	320.675 12.6250	88.900 3.5000	85.725 3.3750	65.088 2.5625	3.5	4.8	790	1 300	80 500	133 000	
	320.675 12.6250	88.900 3.5000	85.725 3.3750	65.088 2.5625	3.5	4.8	855	1 270	87 500	129 000	
	327.025 12.8750	90.488 3.5625	92.075 3.6250	63.500 2.5000	6.4	6.4	930	1 500	95 000	153 000	
	365.049 14.3720	92.075 3.6250	88.897 3.4999	63.500 2.5000	12.7	3.3	875	1 340	89 000	137 000	
	368.300 14.5000	92.075 3.6250	88.897 3.4999	63.500 2.5000	12.7	3.3	875	1 340	89 000	137 000	
	179.972 7.0855	317.500 12.5000	63.500 2.5000	63.500 2.5000	46.038 1.8125	3.5	3.3	575	1 060	59 000	108 000
		317.500 12.5000	68.262 2.6875	63.500 2.5000	50.800 2.0000	3.5	3.3	575	1 060	59 000	108 000
	184.150 7.2500	236.538 9.3125	26.192 1.0312	25.400 1.0000	19.050 0.7500	1.5	1.5	155	291	15 800	29 700
266.700 10.5000		47.625 1.8750	46.833 1.8438	38.100 1.5000	3.5	3.3	345	720	35 000	73 000	
187.325 7.3750	266.700 10.5000	47.625 1.8750	46.833 1.8438	38.100 1.5000	3.5	3.3	345	720	35 000	73 000	
	269.875 10.6250	55.562 2.1875	55.562 2.1875	42.862 1.6875	3.5	3.3	490	920	50 000	93 500	
	282.575 11.1250	50.800 2.0000	47.625 1.8750	36.512 1.4375	3.5	3.3	360	600	36 500	61 500	
	319.964 12.5970	88.900 3.5000	85.725 3.3750	65.088 2.5625	5.5	4.8	855	1 270	87 500	129 000	
	320.675 12.6250	88.900 3.5000	85.725 3.3750	65.088 2.5625	5.5	4.8	855	1 270	87 500	129 000	

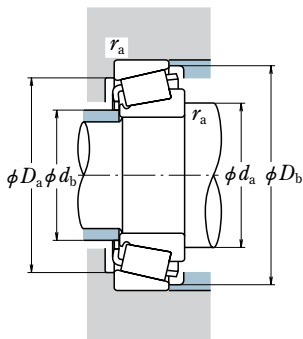

Dynamic Equivalent Load

$$P = XF_r + YF_a$$

$F_a/F_r \leq e$		$F_a/F_r > e$	
X	Y	X	Y
1	0	0.4	Y_1

Static Equivalent Load

$$P_0 = 0.5F_r + Y_0F_a$$

When $F_r > 0.5F_r + Y_0F_a$, use $P_0 = F_r$

The values of e , Y_1 , and Y_0 are given in the table below.

Bearing Numbers	Abutment and Fillet Dimensions (mm)						Eff. Load Centers (mm) a	Constant e	Axial Load Factors		Mass (kg) approx.
	d_a	d_b	D_a	D_b	CONE r_a max.	CUP			Y_1	Y_0	
EE222070 / 222126	218	199	287	307	3.5	4.8	72.6	0.40	1.5	0.83	28.4
H239640 / H239610	215	197	292	309	3.5	4.8	66.3	0.32	1.9	1.0	26.9
EE222070 / 222128	218	199	287	308	3.5	4.8	72.6	0.40	1.5	0.83	28.6
H239640 / H239612	215	197	292	309	3.5	4.8	66.3	0.32	1.9	1.0	27
EE470078 / 470128	223	200	294	315	6.4	6.4	68.6	0.37	1.6	0.90	31
EE420701 / 421437	243	214	332	351	12.7	3.3	78.9	0.42	1.4	0.79	41.1
EE420701 / 421450	243	214	333	353	12.7	3.3	78.9	0.42	1.4	0.79	42
93708 / 93125	224	206	288	306	3.5	3.3	71.0	0.52	1.1	0.63	21.2
93708 / 93126	224	206	286	306	3.5	3.3	75.8	0.52	1.1	0.63	22.1
LL537649 / LL537610	199	193	225	230	1.5	1.5	38.0	0.37	1.6	0.89	2.66
67883 / 67820	212	198	246	260	3.5	3.3	57.9	0.48	1.3	0.69	8.73
67884 / 67820	214	200	246	260	3.5	3.3	57.9	0.48	1.3	0.69	8.39
M238849 / M238810	211	198	250	261	3.5	3.3	49.6	0.33	1.8	0.99	10.1
87737 / 87111	215	202	262	274	3.5	3.3	54.8	0.42	1.4	0.79	9.94
H239649 / H239610	222	202	292	309	5.5	4.8	66.3	0.32	1.9	1.0	25
H239649 / H239612	222	202	292	309	5.5	4.8	66.3	0.32	1.9	1.0	25.2

SINGLE-ROW TAPERED ROLLER BEARINGS (INCH DESIGN)

Bore Diameter 190.000 – 200.000 mm

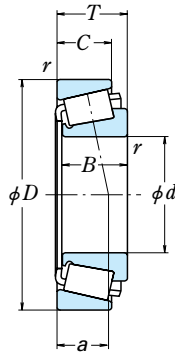

<i>d</i>	Boundary Dimensions (mm/inch)					Basic Load Ratings (kN) (kgf)				
	<i>D</i>	<i>T</i>	<i>B</i>	<i>C</i>	CONE <i>r</i> min.	CUP	<i>C_r</i>	<i>C_{0r}</i>	<i>C_r</i>	<i>C_{0r}</i>
190.000 7.4803	260.000 10.2362	46.000 1.8110	44.000 1.7323	36.500 1.4370	3.0	2.5	370	730	38 000	74 500
190.500 7.5000	266.700 10.5000	47.625 1.8750	46.833 1.8438	38.100 1.5000	3.5	3.3	345	720	35 000	73 000
	282.575 11.1250	50.800 2.0000	47.625 1.8750	36.512 1.4375	3.5	3.3	360	600	36 500	61 500
	317.500 12.5000	63.500 2.5000	63.500 2.5000	46.038 1.8125	4.3	3.3	575	1 060	59 000	108 000
	317.500 12.5000	68.262 2.6875	63.500 2.5000	50.800 2.0000	4.3	3.3	575	1 060	59 000	108 000
	327.025 12.8750	90.488 3.5625	92.075 3.6250	63.500 2.5000	6.4	6.4	930	1 500	95 000	153 000
	336.550 13.2500	98.425 3.8750	95.250 3.7500	73.025 2.8750	6.4	6.4	940	1 600	95 500	163 000
	368.300 14.5000	92.075 3.6250	88.897 3.4999	63.500 2.5000	6.4	3.3	875	1 340	89 000	137 000
	428.625 16.8750	106.362 4.1875	95.250 3.7500	61.912 2.4375	6.4	6.4	1 140	1 400	116 000	143 000
193.675 7.6250	282.575 11.1250	50.800 2.0000	47.625 1.8750	36.512 1.4375	3.5	3.3	360	600	36 500	61 500
196.850 7.7500	241.300 9.5000	23.812 0.9375	23.017 0.9062	17.462 0.6875	1.5	1.5	131	293	13 400	29 900
	254.000 10.0000	28.575 1.1250	27.783 1.0938	21.433 0.8438	1.5	1.5	177	355	18 100	36 500
	257.175 10.1250	39.688 1.5625	39.688 1.5625	30.162 1.1875	3.5	3.3	271	620	27 600	63 500
	317.500 12.5000	63.500 2.5000	63.500 2.5000	46.038 1.8125	4.3	3.3	575	1 060	59 000	108 000
	317.500 12.5000	68.262 2.6875	63.500 2.5000	50.800 2.0000	4.3	3.3	575	1 060	59 000	108 000
200.000 7.8740	300.000 11.8110	65.000 2.5591	62.000 2.4409	51.000 2.0079	3.5	2.5	615	1 130	62 500	116 000

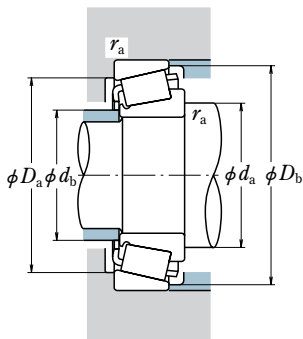

Dynamic Equivalent Load

$$P = XF_r + YF_a$$

$F_a/F_r \leq e$		$F_a/F_r > e$	
X	Y	X	Y
1	0	0.4	Y_1

Static Equivalent Load

$$P_0 = 0.5F_r + Y_0F_a$$

When $F_r > 0.5F_r + Y_0F_a$, use $P_0 = F_r$

The values of e , Y_1 , and Y_0 are given in the table below.

Bearing Numbers	Abutment and Fillet Dimensions (mm)						Eff. Load Centers (mm) \bar{a}	Constant e	Axial Load Factors		Mass (kg) approx.
	d_a	d_b	D_a	D_b	CONE r_a max.	CUP			Y_1	Y_0	
▲JM738249 / JM738210	212	198	241	255	3.0	2.5	56.4	0.48	1.3	0.69	6.94
67885 / 67820	215	202	246	260	3.5	3.3	57.9	0.48	1.3	0.69	8.04
87750 / 87111	217	204	262	274	3.5	3.3	54.8	0.42	1.4	0.79	9.59
93750 / 93125	231	211	288	306	4.3	3.3	71.0	0.52	1.1	0.63	19.7
93750 / 93126	231	211	286	306	4.3	3.3	75.8	0.52	1.1	0.63	20.6
EE470075 / 470128	229	206	294	315	6.4	6.4	68.6	0.37	1.6	0.90	28.3
HH840249 / HH840210	237	205	292	325	6.4	6.4	93.7	0.58	1.0	0.57	35.7
EE420751 / 421450	243	220	333	353	6.4	3.3	78.9	0.42	1.4	0.79	39.6
EE350750-N1 / 351687	246	213	369	405	6.4	6.4	119.0	0.76	0.79	0.44	57.9
87762 / 87111	218	205	262	274	3.5	3.3	54.8	0.42	1.4	0.79	9.23
LL639249 / LL639210	210	204	230	236	1.5	1.5	41.4	0.42	1.4	0.79	2.23
L540049 / L540010	213	206	241	247	1.5	1.5	42.9	0.40	1.5	0.83	3.48
LM739749 / LM739710	218	206	240	251	3.5	3.3	51.3	0.45	1.3	0.73	5.33
93775 / 93125	234	214	288	306	4.3	3.3	71.0	0.52	1.1	0.63	18.7
93775 / 93126	234	214	286	306	4.3	3.3	75.8	0.52	1.1	0.63	19.7
▲JHM840449 / JHM840410	230	211	274	292	3.5	2.5	73.1	0.52	1.2	0.63	15.5

Note ▲ The tolerances are listed in tables 2 to 4 on page B 99.

SINGLE-ROW TAPERED ROLLER BEARINGS (INCH DESIGN)

Bore Diameter 200.025 – 203.200 mm

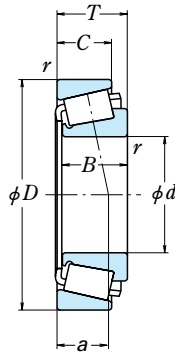

<i>d</i>	Boundary Dimensions (mm/inch)					Basic Load Ratings (kN) (kgf)				
	<i>D</i>	<i>T</i>	<i>B</i>	<i>C</i>	CONE <i>r</i> min.	CUP	<i>C_r</i>	<i>C_{0r}</i>	<i>C_r</i>	<i>C_{0r}</i>
200.025 7.8750	317.500 12.5000	63.500 2.5000	63.500 2.5000	46.038 1.8125	4.3	3.3	575	1 060	59 000	108 000
	317.500 12.5000	68.262 2.6875	63.500 2.5000	50.800 2.0000	4.3	3.3	575	1 060	59 000	108 000
	333.375 13.1250	69.850 2.7500	69.850 2.7500	52.388 2.0625	6.4	6.4	690	1 190	70 000	121 000
	355.600 14.0000	69.850 2.7500	69.850 2.7500	49.212 1.9375	6.8	1.5	695	1 230	71 000	126 000
	384.175 15.1250	112.712 4.4375	112.712 4.4375	90.488 3.5625	6.4	6.4	1 220	2 220	124 000	227 000
	393.700 15.5000	111.125 4.3750	111.125 4.3750	84.138 3.3125	6.4	6.4	1 300	2 030	133 000	207 000
	201.612 7.9375	360.000 14.1732	92.075 3.6250	88.897 3.4999	63.500 2.5000	3.3	3.3	875	1 340	89 000
203.200 8.0000	261.142 10.2812	28.575 1.1250	27.783 1.0938	21.433 0.8438	1.5	1.5	176	355	18 000	36 500
	276.225 10.8750	42.862 1.6875	42.862 1.6875	34.133 1.3438	3.5	3.3	335	620	34 500	63 500
	282.575 11.1250	46.038 1.8125	46.038 1.8125	36.512 1.4375	3.5	3.3	365	800	37 500	81 500
	317.500 12.5000	53.975 2.1250	53.975 2.1250	34.925 1.3750	4.0	3.3	460	725	47 000	74 000
	317.500 12.5000	63.500 2.5000	63.500 2.5000	46.038 1.8125	4.3	3.3	575	1 060	59 000	108 000
	317.500 12.5000	63.500 2.5000	63.500 2.5000	46.038 1.8125	7.9	3.3	575	1 060	59 000	108 000
	317.500 12.5000	66.675 2.6250	66.675 2.6250	50.800 2.0000	4.3	3.3	615	995	62 500	102 000
	317.500 12.5000	68.262 2.6875	63.500 2.5000	50.800 2.0000	4.3	3.3	575	1 060	59 000	108 000
	317.500 12.5000	68.262 2.6875	63.500 2.5000	50.800 2.0000	7.9	3.3	575	1 060	59 000	108 000

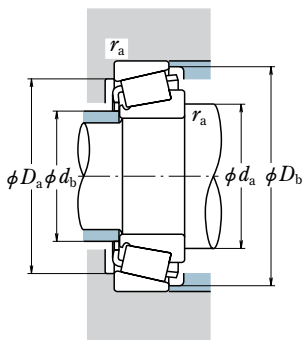

Dynamic Equivalent Load

$$P = XF_r + YF_a$$

$F_a/F_r \leq e$		$F_a/F_r > e$	
X	Y	X	Y
1	0	0.4	Y_1

Static Equivalent Load

$$P_0 = 0.5F_r + Y_0F_a$$

When $F_r > 0.5F_r + Y_0F_a$, use $P_0 = F_r$

The values of e , Y_1 , and Y_0 are given in the table below.

Bearing Numbers	Abutment and Fillet Dimensions (mm)						Eff. Load Centers (mm) \bar{a}	Constant e	Axial Load Factors		Mass (kg) approx.
	d_a	d_b	D_a	D_b	CONE r_a max.	CUP r_a			Y_1	Y_0	
93787 / 93125	235	216	288	306	4.3	3.3	71.0	0.52	1.1	0.63	18.3
93787 / 93126	235	216	286	306	4.3	3.3	75.8	0.52	1.1	0.63	19.2
HM743337 / HM743310	242	222	302	322	6.4	6.4	71.3	0.44	1.4	0.75	23.3
EE130787 / 131400	250	232	329	340	6.8	1.5	59.8	0.33	1.8	0.99	28.3
H247535 / H247510	258	234	344	369	6.4	6.4	84.2	0.33	1.8	0.99	58.8
HH144642 / HH144614	251	227	352	374	6.4	6.4	78.1	0.30	2.0	1.1	57.4
EE420793 / 421417	246	226	329	349	3.3	3.3	78.9	0.42	1.4	0.79	34.9
LL641149 / LL641110	219	212	247	254	1.5	1.5	43.7	0.41	1.5	0.81	3.54
LM241149 / LM241110	224	213	259	269	3.5	3.3	44.0	0.32	1.9	1.0	6.84
67983 / 67920	230	215	261	276	3.5	3.3	61.9	0.51	1.2	0.65	8.85
EE132083 / 132125	232	219	293	302	4.0	3.3	48.0	0.31	1.9	1.1	13.5
93800 / 93125	237	217	288	306	4.3	3.3	71.0	0.52	1.1	0.63	17.8
93800A / 93125	240	217	288	306	7.9	3.3	71.0	0.52	1.1	0.63	17.7
EE122080 / 122125	234	218	293	305	4.3	3.3	55.9	0.30	2.0	1.1	17.4
93800 / 93126	237	217	286	306	4.3	3.3	75.8	0.52	1.1	0.63	18.7
93800A / 93126	240	217	286	306	7.9	3.3	75.8	0.52	1.1	0.63	18.6

SINGLE-ROW TAPERED ROLLER BEARINGS (INCH DESIGN)

Bore Diameter 203.200 – 209.550 mm

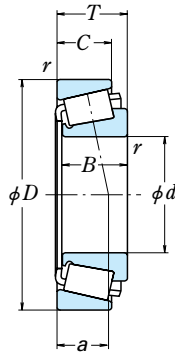

<i>d</i>	Boundary Dimensions (mm/inch)					Basic Load Ratings (kN) (kgf)				
	<i>D</i>	<i>T</i>	<i>B</i>	<i>C</i>	CONE <i>r</i> min.	CUP	<i>C_r</i>	<i>C_{0r}</i>	<i>C_r</i>	<i>C_{0r}</i>
203.200 8.0000	360.000	92.075	88.897	63.500	3.3	3.3	875	1 340	89 000	137 000
	14.1732	3.6250	3.4999	2.5000						
	365.049	92.075	88.897	63.500	3.3	3.3	875	1 340	89 000	137 000
	14.3720	3.6250	3.4999	2.5000						
	368.300	92.075	88.897	63.500	3.3	3.3	875	1 340	89 000	137 000
	14.5000	3.6250	3.4999	2.5000						
	406.400	92.075	85.725	57.150	6.4	6.4	935	1 310	95 000	133 000
	16.0000	3.6250	3.3750	2.2500						
	482.600	117.475	95.250	73.025	6.4	6.4	1 190	1 590	121 000	163 000
	19.0000	4.6250	3.7500	2.8750						
204.788 8.0625	292.100	57.945	57.945	46.038	3.5	3.3	540	1 050	55 000	107 000
	11.5000	2.2813	2.2813	1.8125						
206.375 8.1250	282.575	46.038	46.038	36.512	3.5	3.3	365	800	37 500	81 500
	11.1250	1.8125	1.8125	1.4375						
	317.500	53.975	53.975	34.925	4.0	3.3	460	725	47 000	74 000
	12.5000	2.1250	2.1250	1.3750						
	336.550	98.425	100.012	77.788	3.3	3.3	1 040	1 900	106 000	194 000
	13.2500	3.8750	3.9375	3.0625						
209.550 8.2500	282.575	46.038	46.038	36.512	3.5	3.3	365	800	37 500	81 500
	11.1250	1.8125	1.8125	1.4375						
	317.500	63.500	63.500	46.038	4.3	3.3	575	1 060	59 000	108 000
	12.5000	2.5000	2.5000	1.8125						
	317.500	63.500	63.500	46.038	12.7	3.3	575	1 060	59 000	108 000
	12.5000	2.5000	2.5000	1.8125						
	317.500	68.262	63.500	50.800	4.3	3.3	575	1 060	59 000	108 000
	12.5000	2.6875	2.5000	2.0000						
	317.500	68.262	63.500	50.800	12.7	3.3	575	1 060	59 000	108 000
	12.5000	2.6875	2.5000	2.0000						
	333.375	69.850	69.850	52.388	6.4	6.4	690	1 190	70 000	121 000
	13.1250	2.7500	2.7500	2.0625						
	355.600	68.262	66.675	47.625	7.0	3.3	605	1 170	61 500	120 000
	14.0000	2.6875	2.6250	1.8750						

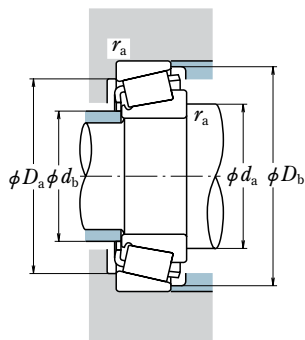

Dynamic Equivalent Load

$$P = XF_r + YF_a$$

$F_a/F_r \leq e$		$F_a/F_r > e$	
X	Y	X	Y
1	0	0.4	Y_1

Static Equivalent Load

$$P_0 = 0.5F_r + Y_0F_a$$

When $F_r > 0.5F_r + Y_0F_a$, use $P_0 = F_r$

The values of e , Y_1 , and Y_0 are given in the table below.

Bearing Numbers	Abutment and Fillet Dimensions (mm)						Eff. Load Centers (mm) a	Constant e	Axial Load Factors		Mass (kg)
	d_a	d_b	D_a	D_b	CONE r_a max.	CUP			Y_1	Y_0	
EE420801 / 421417	246	227	329	349	3.3	3.3	78.9	0.42	1.4	0.79	34.5
EE420801 / 421437	246	227	332	351	3.3	3.3	78.9	0.42	1.4	0.79	36
EE420801 / 421450	246	227	333	353	3.3	3.3	78.9	0.42	1.4	0.79	36.9
EE114080 / 114160	260	226	352	387	6.4	6.4	119.9	0.79	0.75	0.42	48.1
EE380080 / 380190	274	236	408	451	6.4	6.4	148.6	0.87	0.69	0.38	88.7
M241549 / M241510	229	216	271	283	3.5	3.3	52.8	0.33	1.8	0.99	12.1
67985 / 67920	231	216	261	276	3.5	3.3	61.9	0.51	1.2	0.65	8.48
EE132084 / 132125	234	220	293	302	4.0	3.3	48.0	0.31	1.9	1.1	13
H242649 / H242610	242	222	306	325	3.3	3.3	73.4	0.33	1.8	0.99	32.8
67989 / 67920	233	218	261	276	3.5	3.3	61.9	0.51	1.2	0.65	8.11
93825 / 93125	240	221	288	306	4.3	3.3	71.0	0.52	1.1	0.63	16.7
93825A / 93125	248	221	288	306	12.7	3.3	71.0	0.52	1.1	0.63	16.6
93825 / 93126	240	221	286	306	4.3	3.3	75.8	0.52	1.1	0.63	17.6
93825A / 93126	248	221	286	306	12.7	3.3	75.8	0.52	1.1	0.63	17.5
HM743345 / HM743310	247	227	302	322	6.4	6.4	71.3	0.44	1.4	0.75	21.7
96825 / 96140	260	236	321	343	7.0	3.3	85.9	0.59	1.0	0.56	26.7

SINGLE-ROW TAPERED ROLLER BEARINGS (INCH DESIGN)

Bore Diameter 212.725 – 228.600 mm

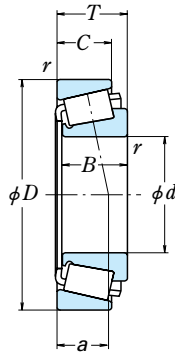

<i>d</i>	Boundary Dimensions (mm/inch)					Basic Load Ratings (kN) (kgf)				
	<i>D</i>	<i>T</i>	<i>B</i>	<i>C</i>	<i>CONE</i> <i>r</i> min.	<i>CUP</i>	<i>C_r</i>	<i>C_{0r}</i>	<i>C_r</i>	<i>C_{0r}</i>
212.725 8.3750	285.750 11.2500	46.038 1.8125	46.038 1.8125	34.925 1.3750	3.5	3.3	350	755	35 500	77 000
215.900 8.5000	285.750 11.2500	46.038 1.8125	46.038 1.8125	34.925 1.3750	3.5	3.3	350	755	35 500	77 000
	290.010 11.4177	31.750 1.2500	31.750 1.2500	22.225 0.8750	3.5	3.3	225	455	22 900	46 500
	355.600 14.0000	69.850 2.7500	69.850 2.7500	49.212 1.9375	6.8	1.5	695	1 230	71 000	126 000
219.969 8.6602	290.010 11.4177	31.750 1.2500	31.750 1.2500	22.225 0.8750	3.5	3.3	225	455	22 900	46 500
220.662 8.6875	314.325 12.3750	61.912 2.4375	61.912 2.4375	49.212 1.9375	6.4	3.3	595	1 190	61 000	122 000
225.425 8.8750	355.600 14.0000	69.850 2.7500	69.850 2.7500	49.212 1.9375	6.8	1.5	695	1 230	71 000	126 000
	400.050 15.7500	88.900 3.5000	87.312 3.4375	63.500 2.5000	1.5	3.3	945	1 510	96 500	154 000
228.397 8.9920	431.800 17.0000	92.075 3.6250	85.725 3.3750	49.212 1.9375	6.4	6.4	885	1 320	90 000	134 000
228.460 8.9945	431.800 17.0000	92.075 3.6250	85.725 3.3750	49.212 1.9375	6.4	6.4	885	1 320	90 000	134 000
228.600 9.0000	295.275 11.6250	33.338 1.3125	31.750 1.2500	23.812 0.9375	3.5	3.3	224	460	22 900	47 000
	300.038 11.8125	33.338 1.3125	31.750 1.2500	23.812 0.9375	3.5	3.3	224	460	22 900	47 000
	320.675 12.6250	50.800 2.0000	49.212 1.9375	33.338 1.3125	6.4	3.3	445	840	45 500	85 500
	327.025 12.8750	52.388 2.0625	49.212 1.9375	34.925 1.3750	6.4	3.3	445	840	45 500	85 500
	327.025 12.8750	52.388 2.0625	52.388 2.0625	36.512 1.4375	6.4	3.3	470	940	48 000	96 000
	355.600 14.0000	68.262 2.6875	66.675 2.6250	47.625 1.8750	7.0	3.3	605	1 170	61 500	120 000

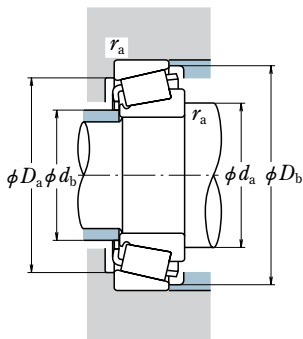

Dynamic Equivalent Load

$$P = XF_r + YF_a$$

$F_a/F_r \leq e$		$F_a/F_r > e$	
X	Y	X	Y
1	0	0.4	Y_1

Static Equivalent Load

$$P_0 = 0.5F_r + Y_0F_a$$

When $F_r > 0.5F_r + Y_0F_a$, use $P_0 = F_r$

The values of e , Y_1 , and Y_0 are given in the table below.

Bearing Numbers	Abutment and Fillet Dimensions (mm)						Eff. Load Centers (mm) \bar{a}	Constant e	Axial Load Factors		Mass (kg) approx.
	d_a	d_b	D_a	D_b	CONE r_a max.	CUP r_a			Y_1	Y_0	
LM742745 / LM742710	237	224	267	280	3.5	3.3	60.4	0.48	1.2	0.69	8.15
LM742749 / LM742710	239	225	267	280	3.5	3.3	60.4	0.48	1.2	0.69	7.77
543085 / 543114	237	228	271	279	3.5	3.3	45.3	0.39	1.5	0.85	5.49
EE130851 / 131400	258	240	329	340	6.8	1.5	59.8	0.33	1.8	0.99	25.4
543086 / 543114	239	231	271	279	3.5	3.3	45.3	0.39	1.5	0.85	5.14
M244249 / M244210	250	233	292	305	6.4	3.3	57.0	0.33	1.8	0.99	14.9
EE130889 / 131400	263	245	329	340	6.8	1.5	59.8	0.33	1.8	0.99	23.6
EE430888 / 431575	266	246	359	379	1.5	3.3	82.0	0.44	1.4	0.75	42.6
EE113089 / 113170	287	256	378	410	6.4	6.4	132.5	0.88	0.68	0.38	49
EE113091 / 113170	287	256	378	410	6.4	6.4	132.5	0.88	0.68	0.38	49
544090 / 544116	250	240	279	288	3.5	3.3	49.6	0.40	1.5	0.82	5.25
544090 / 544118	250	240	282	291	3.5	3.3	49.6	0.40	1.5	0.82	5.66
88900 / 88126	260	242	300	312	6.4	3.3	65.4	0.48	1.2	0.68	11.6
88900 / 88128	260	242	302	315	6.4	3.3	67.0	0.48	1.2	0.68	12.7
8573 / 8520	261	244	304	317	6.4	3.3	59.6	0.41	1.5	0.81	13.3
96900 / 96140	270	246	321	343	7.0	3.3	85.9	0.59	1.0	0.56	23.3

SINGLE-ROW TAPERED ROLLER BEARINGS (INCH DESIGN)

Bore Diameter 228.600 – 234.950 mm

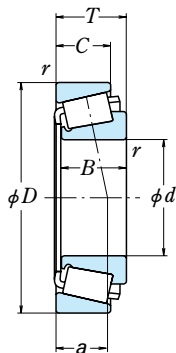

<i>d</i>	Boundary Dimensions (mm/inch)					Basic Load Ratings (kN) (kgf)					
	<i>D</i>	<i>T</i>	<i>B</i>	<i>C</i>	CONE <i>r</i> min.	CUP	<i>C_r</i>	<i>C_{0r}</i>	<i>C_r</i>	<i>C_{0r}</i>	
228.600 9.0000	355.600 14.0000	69.850 2.7500	69.850 2.7500	49.212 1.9375	6.8	1.5	695	1 230	71 000	126 000	
	355.600 14.0000	69.850 2.7500	69.850 2.7500	50.800 2.0000	6.4	6.4	765	1 300	78 000	132 000	
	400.050 15.7500	88.900 3.5000	87.312 3.4375	63.500 2.5000	10.4	3.3	945	1 510	96 500	154 000	
	400.050 15.7500	88.900 3.5000	87.312 3.4375	63.500 2.5000	19.8	3.3	945	1 510	96 500	154 000	
	425.450 16.7500	101.600 4.0000	95.250 3.7500	76.200 3.0000	7.0	6.4	1 280	2 000	131 000	204 000	
	488.950 19.2500	123.825 4.8750	111.125 4.3750	73.025 2.8750	6.4	6.4	1 600	2 500	163 000	254 000	
	508.000 20.0000	117.475 4.6250	95.250 3.7500	73.025 2.8750	6.4	6.4	1 240	1 780	127 000	181 000	
	231.775 9.1250	295.275 11.6250	33.338 1.3125	31.750 1.2500	23.812 0.9375	3.5	3.3	224	460	22 900	47 000
		300.038 11.8125	33.338 1.3125	31.750 1.2500	23.812 0.9375	3.5	3.3	224	460	22 900	47 000
		336.550 13.2500	65.088 2.5625	65.088 2.5625	50.800 2.0000	6.4	3.3	640	1 270	65 000	129 000
358.775 14.1250		71.438 2.8125	71.438 2.8125	53.975 2.1250	6.4	3.3	760	1 540	77 500	157 000	
234.950 9.2500	314.325 12.3750	49.212 1.9375	49.212 1.9375	36.512 1.4375	3.5	3.3	455	955	46 500	97 000	
	320.675 12.6250	50.800 2.0000	49.212 1.9375	33.338 1.3125	6.4	3.3	445	840	45 500	85 500	
	327.025 12.8750	52.388 2.0625	49.212 1.9375	34.925 1.3750	6.4	3.3	445	840	45 500	85 500	
	327.025 12.8750	52.388 2.0625	52.388 2.0625	36.512 1.4375	6.4	3.3	470	940	48 000	96 000	
	355.600 14.0000	68.262 2.6875	66.675 2.6250	47.625 1.8750	7.0	3.3	605	1 170	61 500	120 000	

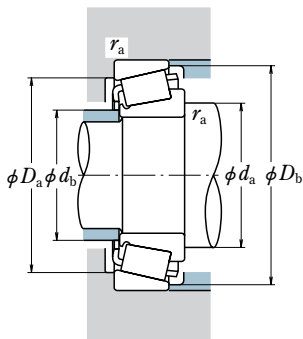

Dynamic Equivalent Load

$$P = XF_r + YF_a$$

$F_a/F_r \leq e$		$F_a/F_r > e$	
X	Y	X	Y
1	0	0.4	Y_1

Static Equivalent Load

$$P_0 = 0.5F_r + Y_0F_a$$

When $F_r > 0.5F_r + Y_0F_a$, use $P_0 = F_r$

The values of e , Y_1 , and Y_0 are given in the table below.

Bearing Numbers	Abutment and Fillet Dimensions (mm)						Eff. Load Centers (mm) \bar{a}	Constant e	Axial Load Factors		Mass (kg)
	d_a	d_b	D_a	D_b	CONE r_a max.	CUP			Y_1	Y_0	
EE130902 / 131400	265	246	329	340	6.8	1.5	59.8	0.33	1.8	0.99	23
HM746646 / HM746610	266	244	324	345	6.4	6.4	75.6	0.47	1.3	0.70	23.1
EE430900 / 431575	277	248	359	379	10.4	3.3	82.0	0.44	1.4	0.75	41.7
EE430902 / 431575	286	248	359	379	19.8	3.3	82.0	0.44	1.4	0.75	41.3
EE700091 / 700167	281	257	384	406	7.0	6.4	80.8	0.33	1.8	0.99	57
HH949549 / HH949510	307	264	420	470	6.4	6.4	166.5	0.94	0.64	0.35	103
EE390090 / 390200	305	266	429	479	6.4	6.4	168.3	0.94	0.64	0.35	96.5
544091 / 544116	251	241	279	288	3.5	3.3	49.6	0.40	1.5	0.82	4.96
544091 / 544118	251	241	282	291	3.5	3.3	49.6	0.40	1.5	0.82	5.38
M246942 / M246910	265	247	313	326	6.4	3.3	60.1	0.33	1.8	0.99	18.4
M249734 / M249710	276	256	335	348	6.4	3.3	64.6	0.33	1.8	0.99	26.2
LM545849 / LM545810	260	247	296	309	3.5	3.3	57.4	0.40	1.5	0.83	10.4
88925 / 88126	263	246	300	312	6.4	3.3	65.4	0.48	1.2	0.68	10.7
88925 / 88128	263	246	302	315	6.4	3.3	67.0	0.48	1.2	0.68	11.8
8575 / 8520	264	248	304	317	6.4	3.3	59.6	0.41	1.5	0.81	12.4
96925 / 96140	273	249	321	343	7.0	3.3	85.9	0.59	1.0	0.56	22.1

SINGLE-ROW TAPERED ROLLER BEARINGS (INCH DESIGN)

Bore Diameter 234.950 – 244.475 mm

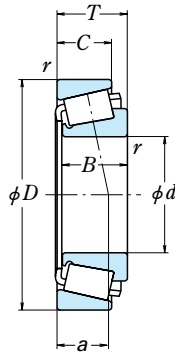

d	Boundary Dimensions (mm/inch)					Basic Load Ratings (kN) (kgf)				
	D	T	B	C	CONE r CUP min.		C_r	C_{0r}	C_r	C_{0r}
234.950 9.2500	384.175 15.1250	112.712 4.4375	112.712 4.4375	90.488 3.5625	6.4	6.4	1 220	2 220	124 000	227 000
237.330 9.3437	336.550 13.2500	65.088 2.5625	65.088 2.5625	50.800 2.0000	6.4	3.3	640	1 270	65 000	129 000
	358.775 14.1250	71.438 2.8125	71.438 2.8125	53.975 2.1250	6.4	3.3	760	1 540	77 500	157 000
241.122 9.4930	368.300 14.5000	68.262 2.6875	68.262 2.6875	53.975 2.1250	6.4	3.3	685	1 210	69 500	124 000
241.300 9.5000	327.025 12.8750	52.388 2.0625	52.388 2.0625	36.512 1.4375	6.4	3.3	470	940	48 000	96 000
	349.148 13.7460	57.150 2.2500	57.150 2.2500	44.450 1.7500	6.4	3.3	570	1 060	58 500	108 000
	355.600 14.0000	50.800 2.0000	50.800 2.0000	33.338 1.3125	6.4	3.3	460	815	47 000	83 500
	355.600 14.0000	57.150 2.2500	57.150 2.2500	44.450 1.7500	6.4	3.3	570	1 060	58 500	108 000
	368.300 14.5000	50.800 2.0000	50.800 2.0000	33.338 1.3125	6.4	3.3	460	815	47 000	83 500
	368.300 14.5000	68.262 2.6875	68.262 2.6875	53.975 2.1250	6.4	3.3	685	1 210	69 500	124 000
	393.700 15.5000	73.817 2.9062	69.850 2.7500	50.005 1.9687	6.4	6.4	700	1 280	71 500	131 000
	406.400 16.0000	69.850 2.7500	69.850 2.7500	46.038 1.8125	6.4	6.4	700	1 280	71 500	131 000
	444.500 17.5000	101.600 4.0000	100.012 3.9375	76.200 3.0000	6.4	4.8	1 410	2 240	143 000	228 000
	488.950 19.2500	120.650 4.7500	120.650 4.7500	92.075 3.6250	6.4	6.4	1 720	2 860	175 000	291 000
	508.000 20.0000	117.475 4.6250	95.250 3.7500	73.025 2.8750	6.4	6.4	1 240	1 780	127 000	181 000
244.475 9.6250	381.000 15.0000	79.375 3.1250	76.200 3.0000	57.150 2.2500	6.4	4.8	820	1 540	84 000	157 000

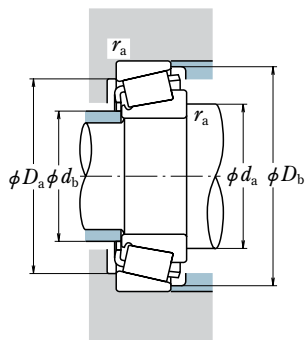

Dynamic Equivalent Load

$$P = XF_r + YF_a$$

$F_a/F_r \leq e$		$F_a/F_r > e$	
X	Y	X	Y
1	0	0.4	Y_1

Static Equivalent Load

$$P_0 = 0.5F_r + Y_0F_a$$

When $F_r > 0.5F_r + Y_0F_a$, use $P_0 = F_r$

The values of e , Y_1 , and Y_0 are given in the table below.

Bearing Numbers	Abutment and Fillet Dimensions (mm)						Eff. Load Centers (mm) \bar{a}	Constant e	Axial Load Factors		Mass (kg)
	d_a	d_b	D_a	D_b	CONE r_a max.	CUP r_a			Y_1	Y_0	
H247549 / H247510	276	251	344	369	6.4	6.4	84.2	0.33	1.8	0.99	48.2
M246949 / M246910	268	250	313	326	6.4	3.3	60.1	0.33	1.8	0.99	17.3
M249736 / M249710	279	259	335	348	6.4	3.3	64.6	0.33	1.8	0.99	25
EE125094 / 125145	277	258	339	354	6.4	3.3	65.3	0.34	1.7	0.96	24.1
8578 / 8520	267	250	304	317	6.4	3.3	59.6	0.41	1.5	0.81	11.4
EE127095 / 127135	274	257	325	338	6.4	3.3	59.5	0.35	1.7	0.93	16.8
EE170950 / 171400	275	260	331	341	6.4	3.3	56.0	0.36	1.7	0.91	15.2
EE127095 / 127140	274	257	328	341	6.4	3.3	59.5	0.35	1.7	0.93	18
EE170950 / 171450	275	260	338	348	6.4	3.3	56.0	0.36	1.7	0.91	17.1
EE125095 / 125145	278	258	339	354	6.4	3.3	65.3	0.34	1.7	0.96	24.1
EE275095 / 275155	293	274	364	382	6.4	6.4	76.1	0.40	1.5	0.82	32.3
EE275095 / 275160	293	274	371	389	6.4	6.4	72.1	0.40	1.5	0.82	34.3
EE923095 / 923175	295	273	403	423	6.4	4.8	84.4	0.34	1.8	0.98	65.4
EE295950 / 295193	315	288	445	469	6.4	6.4	92.8	0.31	1.9	1.1	101
EE390095 / 390200	312	272	429	479	6.4	6.4	168.3	0.94	0.64	0.35	93
EE126097 / 126150	286	261	344	367	6.4	4.8	87.5	0.52	1.2	0.64	30.7

SINGLE-ROW TAPERED ROLLER BEARINGS (INCH DESIGN)

Bore Diameter 247.650 – 254.000 mm

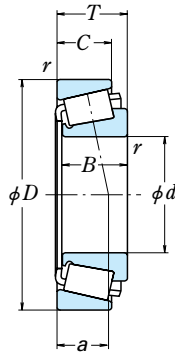

<i>d</i>	Boundary Dimensions (mm/inch)					Basic Load Ratings (kN) (kgf)				
	<i>D</i>	<i>T</i>	<i>B</i>	<i>C</i>	<i>r</i> CONE min.	CUP	<i>C_r</i>	<i>C_{0r}</i>	<i>C_r</i>	<i>C_{0r}</i>
247.650 9.7500	355.600	50.800	50.800	33.338	6.4	3.3	460	815	47 000	83 500
	14.0000	2.0000	2.0000	1.3125						
	368.300	50.800	50.800	33.338	6.4	3.3	460	815	47 000	83 500
	14.5000	2.0000	2.0000	1.3125						
	406.400	115.888	117.475	93.662	6.4	6.4	1 610	3 100	164 000	320 000
	16.0000	4.5625	4.6250	3.6875						
254.000 10.0000	317.500	22.225	22.225	15.875	1.5	1.5	153	380	15 600	38 500
	12.5000	0.8750	0.8750	0.6250						
	323.850	22.225	22.225	15.875	1.5	1.5	153	380	15 600	38 500
	12.7500	0.8750	0.8750	0.6250						
	358.775	71.438	71.438	53.975	3.5	3.3	760	1 540	77 500	157 000
	14.1250	2.8125	2.8125	2.1250						
	365.125	58.738	58.738	42.862	6.4	6.4	580	1 100	59 000	112 000
	14.3750	2.3125	2.3125	1.6875						
	368.300	58.738	58.738	42.862	6.4	6.4	580	1 100	59 000	112 000
	14.5000	2.3125	2.3125	1.6875						
	393.700	73.817	69.850	50.005	6.4	6.4	700	1 280	71 500	131 000
	15.5000	2.9062	2.7500	1.9687						
	400.050	57.150	55.562	41.275	3.3	1.5	635	1 050	65 000	107 000
	15.7500	2.2500	2.1875	1.6250						
	406.400	69.850	69.850	46.038	6.4	6.4	700	1 280	71 500	131 000
	16.0000	2.7500	2.7500	1.8125						
	422.275	86.121	79.771	66.675	6.8	3.3	1 140	1 850	116 000	188 000
16.6250	3.3906	3.1406	2.6250							
431.724	82.550	79.771	60.325	6.8	3.5	1 140	1 850	116 000	188 000	
16.9970	3.2500	3.1406	2.3750							
444.500	76.200	73.025	50.800	6.4	6.4	995	1 500	101 000	153 000	
17.5000	3.0000	2.8750	2.0000							
495.300	76.200	74.612	53.975	6.4	3.3	1 080	1 790	110 000	182 000	
19.5000	3.0000	2.9375	2.1250							
533.400	133.350	120.650	77.788	6.4	6.4	1 840	2 770	188 000	283 000	
21.0000	5.2500	4.7500	3.0625							

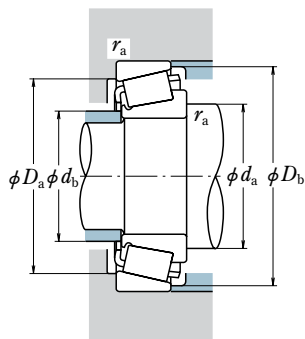

Dynamic Equivalent Load

$$P = XF_r + YF_a$$

$F_a/F_r \leq e$		$F_a/F_r > e$	
X	Y	X	Y
1	0	0.4	Y_1

Static Equivalent Load

$$P_0 = 0.5F_r + Y_0F_a$$

When $F_r > 0.5F_r + Y_0F_a$, use $P_0 = F_r$

The values of e , Y_1 , and Y_0 are given in the table below.

Bearing Numbers	Abutment and Fillet Dimensions (mm)						Eff. Load Centers (mm) \bar{a}	Constant e	Axial Load Factors		Mass (kg) approx.
	d_a	d_b	D_a	D_b	CONE r_a max.	CUP			Y_1	Y_0	
EE170975 / 171400	278	263	331	341	6.4	3.3	56.0	0.36	1.7	0.91	14.2
EE170975 / 171450	278	263	338	348	6.4	3.3	56.0	0.36	1.7	0.91	16.1
HH249949-N2 / HH249910	r_a	266	366	392	6.4	6.4	87.4	0.33	1.8	0.99	58.2
29875 / 29819	276	271	307	311	1.5	1.5	43.4	0.35	1.7	0.95	4.18
29875 / 29820	276	271	310	315	1.5	1.5	43.4	0.35	1.7	0.95	4.57
M249749 / M249710	284	267	335	348	3.5	3.3	64.6	0.33	1.8	0.99	21.5
EE134100 / 134143	289	272	339	354	6.4	6.4	64.2	0.37	1.6	0.88	18.4
EE134100 / 134145	289	272	340	356	6.4	6.4	64.2	0.37	1.6	0.88	19.1
EE275100 / 275155	299	280	364	382	6.4	6.4	76.1	0.40	1.5	0.82	29.6
EE251001 / 251575	291	276	372	381	3.3	1.5	61.2	0.33	1.8	1.0	24.3
EE275100 / 275160	299	280	371	389	6.4	6.4	72.1	0.40	1.5	0.82	31.6
HM252343 / HM252310	301	278	392	408	6.8	3.3	77.6	0.33	1.8	0.99	43.2
HM252343 / HM252315	301	278	397	413	6.8	3.5	74.1	0.33	1.8	0.99	44.9
EE822100 / 822175	302	281	405	421	6.4	6.4	71.1	0.34	1.8	0.97	42.7
EE941002 / 941950	327	304	455	471	6.4	3.3	85.1	0.40	1.5	0.83	64
HH953749 / HH953710	332	285	457	511	6.4	6.4	177.9	0.94	0.64	0.35	127

SINGLE-ROW TAPERED ROLLER BEARINGS (INCH DESIGN)

Bore Diameter 257.175 – 266.700 mm

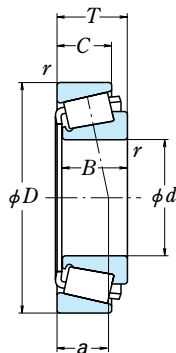

<i>d</i>	Boundary Dimensions (mm/inch)					Basic Load Ratings (kN) (kgf)				
	<i>D</i>	<i>T</i>	<i>B</i>	<i>C</i>	CONE <i>r</i> min.	CUP	<i>C_r</i>	<i>C_{0r}</i>	<i>C_r</i>	<i>C_{0r}</i>
257.175 10.1250	342.900 13.5000	57.150 2.2500	57.150 2.2500	44.450 1.7500	6.4	3.3	560	1 190	57 500	121 000
260.350 10.2500	365.125 14.3750	58.738 2.3125	58.738 2.3125	42.862 1.6875	6.4	6.4	580	1 100	59 000	112 000
	368.300 14.5000	58.738 2.3125	58.738 2.3125	42.862 1.6875	6.4	6.4	580	1 100	59 000	112 000
	400.050 15.7500	69.850 2.7500	67.470 2.6563	46.038 1.8125	9.7	6.4	735	1 220	75 000	124 000
	406.400 16.0000	69.850 2.7500	67.673 2.6643	53.975 2.1250	3.3	3.3	750	1 430	76 500	146 000
	419.100 16.5000	85.725 3.3750	84.138 3.3125	61.912 2.4375	6.4	3.3	960	1 820	98 000	186 000
	422.275 16.6250	86.121 3.3906	79.771 3.1406	66.675 2.6250	6.8	3.3	1 140	1 850	116 000	188 000
	422.275 16.6250	86.124 3.3907	79.711 3.1382	66.675 2.6250	6.8	3.3	975	1 590	99 000	162 000
	431.724 16.9970	82.550 3.2500	79.771 3.1406	60.325 2.3750	6.8	3.5	1 140	1 850	116 000	188 000
	488.950 19.2500	120.650 4.7500	120.650 4.7500	92.075 3.6250	6.4	6.4	1 720	2 860	175 000	291 000
263.525 10.3750	325.438 12.8125	28.575 1.1250	28.575 1.1250	25.400 1.0000	1.5	1.5	228	555	23 300	56 500
	355.600 14.0000	57.150 2.2500	57.150 2.2500	44.450 1.7500	3.5	3.3	615	1 260	63 000	128 000
266.700 10.5000	323.850 12.7500	22.225 0.8750	22.225 0.8750	15.875 0.6250	1.5	1.5	153	380	15 600	38 500
	325.438 12.8125	28.575 1.1250	28.575 1.1250	25.400 1.0000	1.5	1.5	228	555	23 300	56 500
	355.600 14.0000	57.150 2.2500	57.150 2.2500	44.450 1.7500	3.5	3.3	615	1 260	63 000	128 000
	393.700 15.5000	73.817 2.9062	69.850 2.7500	50.005 1.9687	6.4	6.4	700	1 280	71 500	131 000

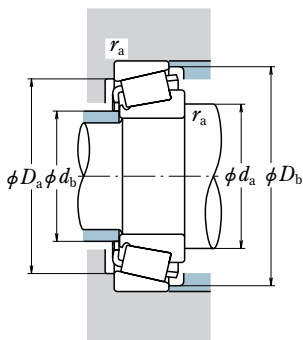

Dynamic Equivalent Load

$$P = XF_r + YF_a$$

$F_a/F_r \leq e$		$F_a/F_r > e$	
X	Y	X	Y
1	0	0.4	Y_1

Static Equivalent Load

$$P_0 = 0.5F_r + Y_0F_a$$

When $F_r > 0.5F_r + Y_0F_a$, use $P_0 = F_r$

The values of e , Y_1 , and Y_0 are given in the table below.

Bearing Numbers	Abutment and Fillet Dimensions (mm)						Eff. Load Centers (mm) a	Constant e	Axial Load Factors		Mass (kg)
	d_a	d_b	D_a	D_b	CONE r_a max.	CUP			Y_1	Y_0	
M349549 / M349510	285	269	323	336	6.4	3.3	59.6	0.35	1.7	0.94	14.1
EE134102 / 134143	293	275	339	354	6.4	6.4	64.2	0.37	1.6	0.88	17.3
EE134102 / 134145	293	275	340	356	6.4	6.4	64.2	0.37	1.6	0.88	17.9
EE221026 / 221575	300	278	366	383	9.7	6.4	71.4	0.39	1.5	0.84	26.7
EE128102 / 128160	302	285	376	391	3.3	3.3	73.5	0.39	1.6	0.86	31.8
EE435102 / 435165	310	281	378	405	6.4	3.3	106.0	0.61	0.99	0.54	42.9
HM252349 / HM252310	304	282	392	408	6.8	3.3	77.6	0.33	1.8	0.99	41.6
EE551026 / 551662	302	281	387	404	6.8	3.3	77.3	0.33	1.8	0.99	41
HM252349 / HM252315	304	282	397	413	6.8	3.5	74.1	0.33	1.8	0.99	43.3
EE295102 / 295193	325	297	445	469	6.4	6.4	92.8	0.31	1.9	1.1	93.8
38880 / 38820	281	274	312	318	1.5	1.5	46.6	0.35	1.7	0.95	5.3
LM451345 / LM451310	290	276	335	348	3.5	3.3	62.4	0.36	1.6	0.90	15.3
29880 / 29820	282	277	310	315	1.5	1.5	43.4	0.35	1.7	0.95	3.67
38885 / 38820	283	276	312	318	1.5	1.5	46.6	0.35	1.7	0.95	5.0
LM451349 / LM451310	292	277	335	348	3.5	3.3	62.4	0.36	1.6	0.90	14.7
EE275105 / 275155	306	286	364	382	6.4	6.4	76.1	0.40	1.5	0.82	26.7

SINGLE-ROW TAPERED ROLLER BEARINGS (INCH DESIGN)

Bore Diameter 266.700 – 288.925 mm

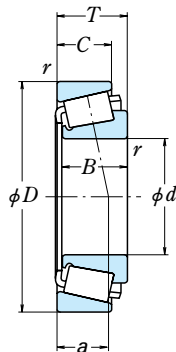

<i>d</i>	Boundary Dimensions (mm/inch)					Basic Load Ratings (kN) (kgf)				
	<i>D</i>	<i>T</i>	<i>B</i>	<i>C</i>	CONE <i>r</i> min.	CUP	<i>C_r</i>	<i>C_{0r}</i>	<i>C_r</i>	<i>C_{0r}</i>
266.700 10.5000	406.400 16.0000	69.850 2.7500	69.850 2.7500	46.038 1.8125	6.4	6.4	700	1 280	71 500	131 000
	422.275 16.6250	86.124 3.3907	79.771 3.1406	66.675 2.6250	6.8	3.3	975	1 590	99 000	162 000
	444.500 17.5000	120.650 4.7500	117.475 4.6250	88.900 3.5000	6.4	6.4	1 610	3 050	164 000	310 000
269.875 10.6250	381.000 15.0000	74.612 2.9375	74.612 2.9375	57.150 2.2500	6.4	3.3	790	1 590	80 500	162 000
273.050 10.7500	393.700 15.5000	73.817 2.9062	69.850 2.7500	50.005 1.9687	6.4	6.4	700	1 280	71 500	131 000
	406.400 16.0000	69.850 2.7500	69.850 2.7500	46.038 1.8125	6.4	6.4	700	1 280	71 500	131 000
276.225 10.8750	352.425 13.8750	36.512 1.4375	34.925 1.3750	23.812 0.9375	3.5	3.3	320	665	32 500	68 000
279.400 11.0000	469.900 18.5000	95.250 3.7500	93.662 3.6875	69.850 2.7500	9.7	3.3	1 180	2 060	120 000	210 000
	488.950 19.2500	120.650 4.7500	120.650 4.7500	92.075 3.6250	1.3	6.4	1 720	2 860	175 000	291 000
280.192 11.0312	406.400 16.0000	52.388 2.0625	50.211 1.9768	34.925 1.3750	6.8	3.3	520	870	53 000	89 000
	406.400 16.0000	69.850 2.7500	67.673 2.6643	53.975 2.1250	6.8	3.3	750	1 430	76 500	146 000
	409.981 16.1410	69.850 2.7500	67.673 2.6643	53.975 2.1250	6.8	3.3	750	1 430	76 500	146 000
285.750 11.2500	358.775 14.1250	33.338 1.3125	31.750 1.2500	22.225 0.8750	3.5	3.3	252	575	25 700	58 500
	380.898 14.9960	65.088 2.5625	65.088 2.5625	49.212 1.9375	3.5	3.3	615	1 490	63 000	152 000
	469.900 18.5000	81.770 3.2193	80.569 3.1720	57.150 2.2500	9.7	3.3	1 100	1 810	112 000	184 000
288.925 11.3750	406.400 16.0000	77.788 3.0625	77.788 3.0625	60.325 2.3750	6.4	3.3	895	1 830	91 000	187 000

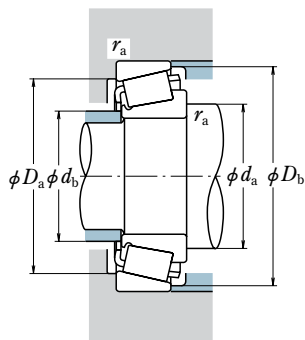

Dynamic Equivalent Load

$$P = XF_r + YF_a$$

$F_a/F_r \leq e$		$F_a/F_r > e$	
X	Y	X	Y
1	0	0.4	Y_1

Static Equivalent Load

$$P_0 = 0.5F_r + Y_0F_a$$

When $F_r > 0.5F_r + Y_0F_a$, use $P_0 = F_r$

The values of e , Y_1 , and Y_0 are given in the table below.

Bearing Numbers	Abutment and Fillet Dimensions (mm)						Eff. Load Centers (mm) a	Constant e	Axial Load Factors		Mass (kg) approx.
	d_a	d_b	D_a	D_b	CONE r_a max.	CUP r_a			Y_1	Y_0	
EE275105 / 275160	306	286	371	389	6.4	6.4	72.1	0.40	1.5	0.82	28.8
EE551050 / 551662	306	284	387	404	6.8	3.3	77.3	0.33	1.8	0.99	39.4
H852849 / H852810	320	282	392	431	6.4	6.4	119.9	0.58	1.0	0.57	72
M252349 / M252310	304	285	356	370	6.4	3.3	68.8	0.33	1.8	0.99	24.8
EE275108 / 275155	309	290	364	382	6.4	6.4	76.1	0.40	1.5	0.82	25.2
EE275108 / 275160	309	290	371	389	6.4	6.4	72.1	0.40	1.5	0.82	27.3
L853049 / L853010	300	288	333	344	3.5	3.3	72.0	0.54	1.1	0.62	7.85
EE722110 / 722185	336	308	431	451	9.7	3.3	87.2	0.38	1.6	0.87	60.9
EE295110 / 295193	329	307	445	469	1.3	6.4	92.8	0.31	1.9	1.1	86.2
EE101103 / 101600	315	299	380	391	6.8	3.3	68.1	0.41	1.5	0.81	18.9
EE128111 / 128160	316	295	376	391	6.8	3.3	73.5	0.39	1.6	0.86	27.2
EE128111 / 128161	316	295	377	393	6.8	3.3	73.5	0.39	1.6	0.86	28.2
545112 / 545141	307	298	339	348	3.5	3.3	66.3	0.49	1.2	0.67	7.09
LM654649 / LM654610	316	300	355	371	3.5	3.3	76.1	0.43	1.4	0.77	20
EE921124 / 921850	338	315	438	451	9.7	3.3	69.4	0.29	2.1	1.1	49.4
M255449 / M255410	324	304	380	395	6.4	3.3	72.8	0.34	1.8	0.98	29.8

SINGLE-ROW TAPERED ROLLER BEARINGS (INCH DESIGN)

Bore Diameter 292.100 – 304.800 mm

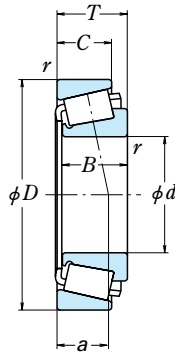

d	Boundary Dimensions (mm/inch)					Basic Load Ratings (kN) (kgf)				
	D	T	B	C	CONE r min.	CUP	C_r	C_{0r}	C_r	C_{0r}
292.100 11.5000	374.650	47.625	47.625	34.925	3.5	3.3	490	1 060	50 000	108 000
	14.7500	1.8750	1.8750	1.3750						
	393.700	63.500	50.800	44.450	3.5	6.4	545	1 120	55 500	115 000
	15.5000	2.5000	2.0000	1.7500						
	469.900	95.250	93.662	69.850	9.7	3.3	1 180	2 060	120 000	210 000
18.5000	3.7500	3.6875	2.7500							
558.800	136.525	136.525	98.425	6.4	6.4	2 480	4 100	253 000	420 000	
22.0000	5.3750	5.3750	3.8750							
298.450 11.7500	431.800	69.850	58.738	53.975	6.4	3.3	755	1 400	77 000	142 000
	17.0000	2.7500	2.3125	2.1250						
	444.500	63.500	61.912	39.688	8.0	3.3	685	1 140	69 500	116 000
17.5000	2.5000	2.4375	1.5625							
444.500	63.500	61.912	39.688	8.0	1.5	685	1 140	69 500	116 000	
17.5000	2.5000	2.4375	1.5625							
300.038 11.8125	422.275	82.550	82.550	63.500	6.4	3.3	990	2 050	101 000	209 000
	16.6250	3.2500	3.2500	2.5000						
304.800 12.0000	393.700	50.800	50.800	38.100	6.4	3.3	530	1 140	54 000	116 000
	15.5000	2.0000	2.0000	1.5000						
	406.400	63.500	63.500	47.625	6.4	3.3	690	1 490	70 500	152 000
	16.0000	2.5000	2.5000	1.8750						
	444.500	63.500	61.912	39.688	8.0	3.3	685	1 140	69 500	116 000
	17.5000	2.5000	2.4375	1.5625						
	444.500	63.500	61.912	39.688	8.0	1.5	685	1 140	69 500	116 000
	17.5000	2.5000	2.4375	1.5625						
	495.300	76.200	74.612	53.975	6.4	3.3	1 080	1 790	110 000	182 000
	19.5000	3.0000	2.9375	2.1250						
495.300	95.250	92.075	69.850	16.0	6.4	1 240	2 150	127 000	220 000	
19.5000	3.7500	3.6250	2.7500							
499.948	101.600	79.375	53.975	6.4	6.4	1 190	2 030	121 000	207 000	
19.6830	4.0000	3.1250	2.1250							
558.800	136.525	136.525	98.425	1.3	6.4	2 480	4 100	253 000	420 000	
22.0000	5.3750	5.3750	3.8750							

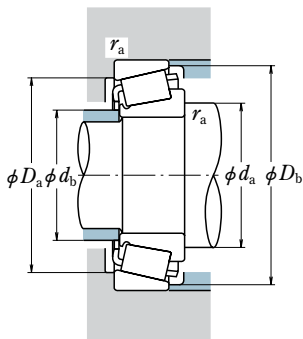

Dynamic Equivalent Load

$$P = XF_r + YF_a$$

$F_a/F_r \leq e$		$F_a/F_r > e$	
X	Y	X	Y
1	0	0.4	Y_1

Static Equivalent Load

$$P_0 = 0.5F_r + Y_0F_a$$

When $F_r > 0.5F_r + Y_0F_a$, use $P_0 = F_r$

The values of e , Y_1 , and Y_0 are given in the table below.

Bearing Numbers	Abutment and Fillet Dimensions (mm)						Eff. Load Centers (mm) a	Constant e	Axial Load Factors		Mass (kg) approx.
	d_a	d_b	D_a	D_b	CONE r_a max.	CUP			Y_1	Y_0	
L555249 / L555210	316	303	355	366	3.5	3.3	64.5	0.40	1.5	0.82	12.5
84115 / 84155	323	305	364	383	3.5	6.4	99.8	0.61	0.99	0.54	18.6
EE722115 / 722185	342	315	431	451	9.7	3.3	87.2	0.38	1.6	0.87	56.7
EE790114 / 790221	362	332	506	537	6.4	6.4	113.5	0.39	1.5	0.84	147
EE111175 / 111700	336	316	400	417	6.4	3.3	88.1	0.44	1.4	0.75	29.2
EE291175 / 291749	339	319	415	427	8.0	3.3	71.8	0.38	1.6	0.87	28.7
EE291175 / 291750	339	319	417	427	8.0	1.5	71.8	0.38	1.6	0.87	28.7
HM256849 / HM256810	337	317	395	411	6.4	3.3	76.7	0.34	1.8	0.98	34.2
L357049 / L357010	334	318	374	385	6.4	3.3	63.7	0.36	1.7	0.92	14.5
LM757049 / LM757010	337	317	380	396	6.4	3.3	79.4	0.44	1.4	0.75	21.4
EE291201 / 291749	342	323	415	427	8.0	3.3	71.8	0.38	1.6	0.87	27.3
EE291201 / 291750	342	323	417	427	8.0	1.5	71.8	0.38	1.6	0.87	27.3
EE941205 / 941950	352	329	455	471	6.4	3.3	85.1	0.40	1.5	0.83	51
EE724120 / 724195	364	329	451	474	16.0	6.4	93.9	0.40	1.5	0.82	63.3
M959442 / M959410	367	327	444	487	6.4	6.4	203.0	1.2	0.51	0.28	67.6
EE790120 / 790221	364	338	506	537	1.3	6.4	113.5	0.39	1.5	0.84	141

SINGLE-ROW TAPERED ROLLER BEARINGS (INCH DESIGN)

Bore Diameter 314.325 – 342.900 mm

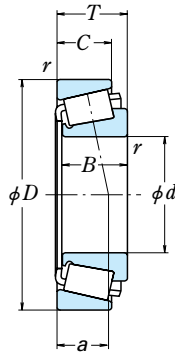

<i>d</i>	Boundary Dimensions (mm/inch)				CONE <i>r</i> min.	CUP <i>r</i>	Basic Load Ratings (kN) (kgf)			
	<i>D</i>	<i>T</i>	<i>B</i>	<i>C</i>			<i>C_r</i>	<i>C_{0r}</i>	<i>C_r</i>	<i>C_{0r}</i>
314.325 12.3750	495.300 19.5000	120.650 4.7500	119.062 4.6875	88.900 3.5000	6.4	6.4	1 710	3 300	174 000	340 000
317.500 12.5000	444.500 17.5000	63.500 2.5000	61.912 2.4375	39.688 1.5625	8.0	1.5	685	1 140	69 500	116 000
	444.500 17.5000	63.500 2.5000	61.912 2.4375	39.688 1.5625	8.0	3.3	685	1 140	69 500	116 000
	447.675 17.6250	85.725 3.3750	85.725 3.3750	68.262 2.6875	3.5	3.3	1 120	2 350	114 000	239 000
	622.300 24.5000	147.638 5.8125	131.762 5.1875	82.550 3.2500	14.3	12.7	2 270	3 800	231 000	385 000
329.870 12.9870	533.400 21.0000	76.200 3.0000	76.200 3.0000	50.800 2.0000	4.7	3.3	1 060	1 800	108 000	184 000
330.200 13.0000	415.925 16.3750	47.625 1.8750	47.625 1.8750	34.925 1.3750	12.7	3.3	505	1 150	51 500	117 000
	415.925 16.3750	47.625 1.8750	47.625 1.8750	34.925 1.3750	3.5	3.3	505	1 150	51 500	117 000
	469.900 18.5000	60.325 2.3750	55.562 2.1875	38.100 1.5000	7.0	6.4	710	1 420	72 000	145 000
	482.600 19.0000	60.325 2.3750	55.562 2.1875	38.100 1.5000	7.0	6.4	710	1 420	72 000	145 000
	482.600 19.0000	66.675 2.6250	63.500 2.5000	44.450 1.7500	6.8	6.8	810	1 560	82 500	159 000
	482.600 19.0000	85.725 3.3750	80.167 3.1562	60.325 2.3750	6.4	3.3	995	1 830	101 000	187 000
	482.600 19.0000	85.725 3.3750	80.167 3.1562	60.325 2.3750	3.3	3.3	995	1 830	101 000	187 000
	488.950 19.2500	60.325 2.3750	55.562 2.1875	38.100 1.5000	7.0	6.4	710	1 420	72 000	145 000
342.900 13.5000	450.850 17.7500	66.675 2.6250	66.675 2.6250	52.388 2.0625	8.5	3.5	805	1 840	82 500	188 000
	533.400 21.0000	76.200 3.0000	76.200 3.0000	50.800 2.0000	4.8	3.3	1 060	1 800	108 000	184 000

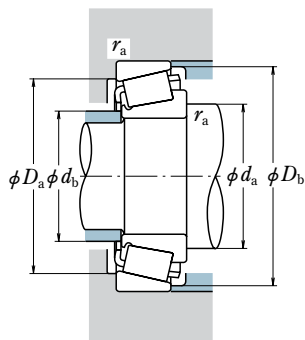

Dynamic Equivalent Load

$$P = XF_r + YF_a$$

$F_a/F_r \leq e$		$F_a/F_r > e$	
X	Y	X	Y
1	0	0.4	Y_1

Static Equivalent Load

$$P_0 = 0.5F_r + Y_0F_a$$

When $F_r > 0.5F_r + Y_0F_a$, use $P_0 = F_r$

The values of e , Y_1 , and Y_0 are given in the table below.

Bearing Numbers	Abutment and Fillet Dimensions (mm)						Eff. Load Centers (mm) a	Constant e	Axial Load Factors		Mass (kg)
	d_a	d_b	D_a	D_b	CONE r_a max.	CUP r_a			Y_1	Y_0	
H859049 / H859010	368	335	446	484	6.4	6.4	125.3	0.55	1.1	0.60	83.8
EE291250 / 291750	349	329	417	427	8.0	1.5	71.8	0.38	1.6	0.87	24.3
EE291250 / 291749	349	329	415	427	8.0	3.3	71.8	0.38	1.6	0.87	24.2
HM259049 / HM259010	353	333	418	435	3.5	3.3	80.1	0.33	1.8	0.99	40.4
H961649 / H961610	414	358	535	597	14.3	12.7	206.4	0.94	0.64	0.35	184
EE971298 / 972100	383	364	497	510	4.7	3.3	78.4	0.33	1.8	0.99	58.5
L860048 / L860010	365	342	394	408	12.7	3.3	83.0	0.50	1.2	0.66	14.3
L860049 / L860010	356	342	394	408	3.5	3.3	83.0	0.50	1.2	0.66	14.6
EE161300 / 161850	377	358	441	459	7.0	6.4	92.7	0.50	1.2	0.66	30.1
EE161300 / 161900	377	358	447	464	7.0	6.4	92.7	0.50	1.2	0.66	32.9
EE203130 / 203190	377	358	450	467	6.8	6.8	84.9	0.42	1.4	0.79	36.4
EE526130 / 526190	370	348	447	465	6.4	3.3	88.9	0.39	1.5	0.85	44.9
EE526132 / 526190	367	348	447	465	3.3	3.3	88.9	0.39	1.5	0.85	45
EE161300 / 161925	377	358	451	468	7.0	6.4	92.7	0.50	1.2	0.66	34.3
LM361649 / LM361610	379	359	426	441	8.5	3.5	75.8	0.35	1.7	0.94	27.2
EE971354 / 972100	390	371	497	510	4.8	3.3	78.4	0.33	1.8	0.99	54.4

SINGLE-ROW TAPERED ROLLER BEARINGS (INCH DESIGN)

Bore Diameter 346.075 – 355.600 mm

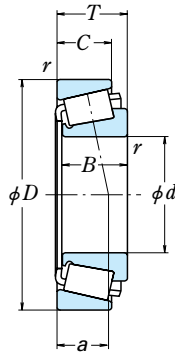

d	Boundary Dimensions (mm/inch)				CONE r CUP		Basic Load Ratings				
	D	T	B	C	r min.	CUP	(kN)		(kgf)		
							C_r	C_{0r}	C_r	C_{0r}	
346.075 13.6250	469.900	60.325	55.562	38.100	7.0	6.4	710	1 420	72 000	145 000	
	18.5000	2.3750	2.1875	1.5000							
	482.600	60.325	55.562	38.100	7.0	6.4	710	1 420	72 000	145 000	
	19.0000	2.3750	2.1875	1.5000							
	482.600	66.675	63.500	44.450	6.8	6.8	810	1 560	82 500	159 000	
	19.0000	2.6250	2.5000	1.7500							
	482.600	66.675	63.500	44.450	12.7	6.8	810	1 560	82 500	159 000	
	19.0000	2.6250	2.5000	1.7500							
	488.950	60.325	55.562	38.100	7.0	6.4	710	1 420	72 000	145 000	
	19.2500	2.3750	2.1875	1.5000							
488.950	95.250	95.250	74.612	6.4	3.3	1 250	2 600	127 000	265 000		
	19.2500	3.7500	3.7500	2.9375							
349.250 13.7500	501.650	90.488	84.138	69.850	6.4	3.3	1 320	2 720	135 000	277 000	
	19.7500	3.5625	3.3125	2.7500							
354.012 13.9375	469.900	60.325	55.562	38.100	7.0	6.4	710	1 420	72 000	145 000	
	18.5000	2.3750	2.1875	1.5000							
	482.600	60.325	55.562	38.100	7.0	6.4	710	1 420	72 000	145 000	
	19.0000	2.3750	2.1875	1.5000							
	488.950	60.325	55.562	38.100	7.0	6.4	710	1 420	72 000	145 000	
	19.2500	2.3750	2.1875	1.5000							
	355.600 14.0000	444.500	60.325	60.325	47.625	3.5	3.3	660	1 660	67 500	169 000
		17.5000	2.3750	2.3750	1.8750						
		469.900	60.325	55.562	38.100	7.0	6.4	710	1 420	72 000	145 000
		18.5000	2.3750	2.1875	1.5000						
482.600		60.325	55.562	38.100	7.0	6.4	710	1 420	72 000	145 000	
19.0000		2.3750	2.1875	1.5000							
488.950		60.325	55.562	38.100	7.0	6.4	710	1 420	72 000	145 000	
19.2500		2.3750	2.1875	1.5000							
501.650		74.612	66.675	50.800	6.4	3.3	795	1 640	81 000	167 000	
19.7500		2.9375	2.6250	2.0000							
501.650	90.488	84.138	69.850	6.4	3.3	1 320	2 720	135 000	277 000		
19.7500	3.5625	3.3125	2.7500								

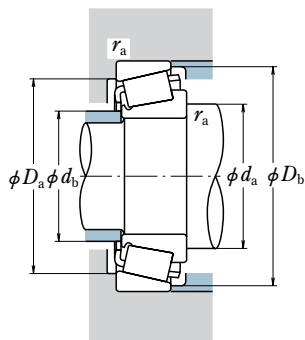

Dynamic Equivalent Load

$$P = XF_r + YF_a$$

$F_a/F_r \leq e$		$F_a/F_r > e$	
X	Y	X	Y
1	0	0.4	Y_1

Static Equivalent Load

$$P_0 = 0.5F_r + Y_0F_a$$

When $F_r > 0.5F_r + Y_0F_a$, use $P_0 = F_r$

The values of e , Y_1 , and Y_0 are given in the table below.

Bearing Numbers	Abutment and Fillet Dimensions (mm)						Eff. Load Centers (mm) a	Constant e	Axial Load Factors		Mass (kg) approx.
	d_a	d_b	D_a	D_b	CONE r_a max.	CUP r_a			Y_1	Y_0	
EE161363 / 161850	385	366	441	459	7.0	6.4	92.7	0.50	1.2	0.66	26.4
EE161363 / 161900	385	366	447	464	7.0	6.4	92.7	0.50	1.2	0.66	29.2
EE203136 / 203190	385	366	450	467	6.8	6.8	84.9	0.42	1.4	0.79	32.2
EE203137 / 203190	391	366	450	467	12.7	6.8	84.9	0.42	1.4	0.79	32
EE161363 / 161925	385	366	451	468	7.0	6.4	92.7	0.50	1.2	0.66	30.7
HM262749 / HM262710	386	364	457	475	6.4	3.3	87.8	0.33	1.8	0.99	52.9
EE333137 / 333197	394	371	470	488	6.4	3.3	95.0	0.37	1.6	0.90	55.8
EE161394 / 161850	389	370	441	459	7.0	6.4	92.7	0.50	1.2	0.66	24.5
EE161394 / 161900	389	370	447	464	7.0	6.4	92.7	0.50	1.2	0.66	27.3
EE161394 / 161925	389	370	451	468	7.0	6.4	92.7	0.50	1.2	0.66	28.8
L163149 / L163110	381	369	423	435	3.5	3.3	67.9	0.31	2.0	1.1	20.6
EE161400 / 161850	390	370	441	459	7.0	6.4	92.7	0.50	1.2	0.66	24.1
EE161400 / 161900	390	370	447	464	7.0	6.4	92.7	0.50	1.2	0.66	26.9
EE161400 / 161925	390	370	451	468	7.0	6.4	92.7	0.50	1.2	0.66	28.4
EE231400 / 231975	403	382	472	489	6.4	3.3	97.0	0.44	1.4	0.75	40.5
EE333140 / 333197	397	374	470	488	6.4	3.3	95.0	0.37	1.6	0.90	53.5

SINGLE-ROW TAPERED ROLLER BEARINGS (INCH DESIGN)

Bore Diameter 355.600 – 385.762 mm

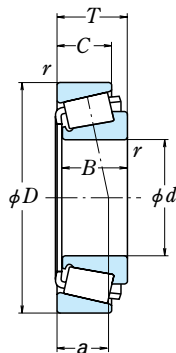

d	Boundary Dimensions (mm/inch)				CONE r min.	CUP	Basic Load Ratings (kN) (kgf)			
	D	T	B	C			C_r	C_{0r}	C_r	C_{0r}
355.600 14.0000	514.350 20.2500	74.612 2.9375	66.675 2.6250	50.800 2.0000	6.4	3.3	795	1 640	81 000	167 000
368.300 14.5000	596.900 23.5000	95.250 3.7500	92.075 3.6250	60.325 2.3750	9.7	6.4	1 670	2 870	170 000	293 000
	609.600 24.0000	142.875 5.6250	139.700 5.5000	111.125 4.3750	8.0	6.4	2 710	4 950	276 000	505 000
371.475 14.6250	501.650 19.7500	74.612 2.9375	66.675 2.6250	50.800 2.0000	6.4	3.3	795	1 640	81 000	167 000
	514.350 20.2500	74.612 2.9375	66.675 2.6250	50.800 2.0000	6.4	3.3	795	1 640	81 000	167 000
374.650 14.7500	522.288 20.5625	85.725 3.3750	84.138 3.3125	61.912 2.4375	6.4	3.3	1 210	2 550	124 000	260 000
377.825 14.8750	508.000 20.0000	63.500 2.5000	58.738 2.3125	38.100 1.5000	6.4	3.3	725	1 490	74 000	152 000
	522.288 20.5625	85.725 3.3750	84.138 3.3125	61.912 2.4375	6.4	3.3	1 210	2 550	124 000	260 000
381.000 15.0000	479.425 18.8750	49.212 1.9375	47.625 1.8750	34.925 1.3750	6.4	3.3	585	1 310	60 000	134 000
	508.000 20.0000	63.500 2.5000	58.738 2.3125	38.100 1.5000	6.4	3.3	725	1 490	74 000	152 000
	522.288 20.5625	85.725 3.3750	84.138 3.3125	61.912 2.4375	6.4	3.3	1 210	2 550	124 000	260 000
	546.100 21.5000	104.775 4.1250	104.775 4.1250	82.550 3.2500	6.4	6.4	1 840	4 000	187 000	405 000
384.175 15.1250	441.325 17.3750	28.575 1.1250	28.575 1.1250	20.638 0.8125	3.5	3.3	247	655	25 200	66 500
	546.100 21.5000	104.775 4.1250	104.775 4.1250	82.550 3.2500	6.4	6.4	1 840	4 000	187 000	405 000
385.762 15.1875	514.350 20.2500	82.550 3.2500	82.550 3.2500	63.500 2.5000	6.4	3.3	1 180	2 610	121 000	266 000

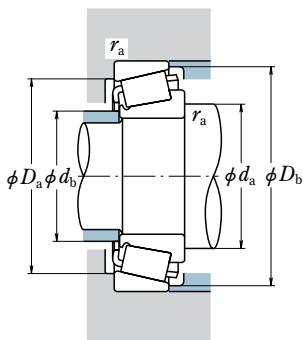

Dynamic Equivalent Load

$$P = XF_r + YF_a$$

$F_a/F_r \leq e$		$F_a/F_r > e$	
X	Y	X	Y
1	0	0.4	Y_1

Static Equivalent Load

$$P_0 = 0.5F_r + Y_0F_a$$

When $F_r > 0.5F_r + Y_0F_a$, use $P_0 = F_r$

The values of e , Y_1 , and Y_0 are given in the table below.

Bearing Numbers	Abutment and Fillet Dimensions (mm)						Eff. Load Centers (mm) a	Constant e	Axial Load Factors		Mass (kg) approx.
	d_a	d_b	D_a	D_b	CONE r_a max.	CUP			Y_1	Y_0	
EE231400 / 232025	403	382	478	495	6.4	3.3	97.0	0.44	1.4	0.75	44.6
EE181453 / 182350	428	403	549	570	9.7	6.4	102.6	0.41	1.5	0.80	92.7
EE321145-N1 / 321240-N	431	401	556	587	8.0	6.4	118.9	0.36	1.7	0.93	160
EE231462 / 231975	411	390	472	489	6.4	3.3	97.0	0.44	1.4	0.75	35.8
EE231462 / 232025	411	390	478	495	6.4	3.3	97.0	0.44	1.4	0.75	39.8
LM565943 / LM565910	417	393	490	508	6.4	3.3	92.9	0.39	1.6	0.86	51.3
EE192148 / 192200	418	397	480	495	6.4	3.3	103.9	0.53	1.1	0.62	31.1
LM565946 / LM565910	418	395	490	508	6.4	3.3	92.9	0.39	1.6	0.86	50
L865547 / L865512	412	394	456	469	6.4	3.3	92.0	0.49	1.2	0.67	18.9
EE192150 / 192200	420	399	480	495	6.4	3.3	103.9	0.53	1.1	0.62	30.3
LM565949 / LM565910	420	396	490	508	6.4	3.3	92.9	0.39	1.6	0.86	48.8
HM266447 / HM266410	428	405	508	531	6.4	6.4	97.5	0.33	1.8	0.99	78.3
LL365348 / LL365310	402	394	427	435	3.5	3.3	59.2	0.34	1.8	0.97	6.33
HM266449 / HM266410	429	407	508	531	6.4	6.4	97.5	0.33	1.8	0.99	76.7
LM665949 / LM665910	424	401	485	504	6.4	3.3	99.0	0.42	1.4	0.79	45.2

SINGLE-ROW TAPERED ROLLER BEARINGS (INCH DESIGN)

Bore Diameter 393.700 – 425.450 mm

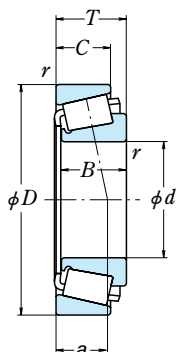

<i>d</i>	Boundary Dimensions (mm/inch)					Basic Load Ratings (kN) (kgf)				
	<i>D</i>	<i>T</i>	<i>B</i>	<i>C</i>	CONE <i>r</i> min.	CUP	<i>C_r</i>	<i>C_{0r}</i>	<i>C_r</i>	<i>C_{0r}</i>
393.700 15.5000	546.100 21.5000	76.200 3.0000	61.120 2.4063	55.562 2.1875	6.4	6.4	815	1 650	83 000	168 000
	558.800 22.0000	65.088 2.5625	61.119 2.4063	44.450 1.7500	6.4	6.4	815	1 650	83 000	168 000
396.875 15.6250	546.100 21.5000	76.200 3.0000	61.120 2.4063	55.562 2.1875	6.4	6.4	815	1 650	83 000	168 000
	549.275 21.6250	85.725 3.3750	84.138 3.3125	61.912 2.4375	6.4	3.3	1 260	2 720	128 000	278 000
	558.800 22.0000	65.088 2.5625	61.120 2.4063	44.450 1.7500	6.4	6.4	815	1 650	83 000	168 000
406.400 16.0000	508.000 20.0000	61.912 2.4375	61.912 2.4375	47.625 1.8750	3.3	3.3	800	1 960	81 500	200 000
	546.100 21.5000	76.200 3.0000	61.120 2.4063	55.562 2.1875	6.4	6.4	815	1 650	83 000	168 000
	549.275 21.6250	85.725 3.3750	84.138 3.3125	61.912 2.4375	6.4	3.3	1 260	2 720	128 000	278 000
	558.800 22.0000	65.088 2.5625	61.120 2.4063	44.450 1.7500	6.4	6.4	815	1 650	83 000	168 000
	574.675 22.6250	76.200 3.0000	67.866 2.6719	50.800 2.0000	6.8	3.3	920	1 850	93 500	189 000
409.575 16.1250	673.100 26.5000	88.900 3.5000	87.833 3.4580	60.325 2.3750	6.4	3.3	1 750	3 100	179 000	315 000
	574.675 22.6250	76.200 3.0000	67.866 2.6719	50.800 2.0000	6.8	3.3	920	1 850	93 500	189 000
411.162 16.1875	609.600 24.0000	92.075 3.6250	84.138 3.3125	60.325 2.3750	6.8	6.4	1 470	2 750	150 000	280 000
	685.698 26.9960	142.875 5.6250	142.800 5.6220	104.775 4.1250	12.7	6.4	3 050	5 700	310 000	580 000

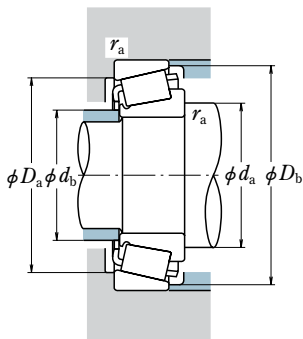

Dynamic Equivalent Load

$$P = XF_r + YF_a$$

$F_a/F_r \leq e$		$F_a/F_r > e$	
X	Y	X	Y
1	0	0.4	Y_1

Static Equivalent Load

$$P_0 = 0.5F_r + Y_0F_a$$

When $F_r > 0.5F_r + Y_0F_a$, use $P_0 = F_r$

The values of e , Y_1 , and Y_0 are given in the table below.

Bearing Numbers	Abutment and Fillet Dimensions (mm)						Eff. Load Centers (mm) a	Constant e	Axial Load Factors		Mass (kg)
	d_a	d_b	D_a	D_b	CONE r_a max.	CUP r_a			Y_1	Y_0	
EE234154 / 234215	438	417	507	529	6.4	6.4	112.9	0.48	1.3	0.69	44.8
EE234154 / 234220	438	417	516	536	6.4	6.4	101.8	0.48	1.3	0.69	44.3
EE234156 / 234215	439	419	507	529	6.4	6.4	112.9	0.48	1.3	0.69	43.9
LM567943 / LM567910	442	420	517	535	6.4	3.3	101.1	0.41	1.5	0.81	57.1
EE234156 / 234220	439	419	516	536	6.4	6.4	101.8	0.48	1.3	0.69	43.4
L467549 / L467510	435	420	484	498	3.3	3.3	83.3	0.37	1.6	0.90	27.6
EE234160 / 234215	444	424	507	529	6.4	6.4	112.9	0.48	1.3	0.69	44.3
LM567949 / LM567910	447	425	517	535	6.4	3.3	101.1	0.41	1.5	0.81	53.2
EE234160 / 234220	444	424	516	536	6.4	6.4	101.8	0.48	1.3	0.69	43.8
EE285160 / 285226	453	429	534	552	6.8	3.3	114.0	0.50	1.2	0.66	53.2
EE571602 / 572650	479	457	629	647	6.4	3.3	110.0	0.40	1.5	0.83	119
EE285162 / 285226	455	431	534	552	6.8	3.3	114.0	0.50	1.2	0.66	52.1
EE911618 / 912400	461	440	566	586	6.8	6.4	103.9	0.38	1.6	0.86	80.7
EE328167 / 328269	497	462	630	661	12.7	6.4	135.1	0.40	1.5	0.83	193

SINGLE-ROW TAPERED ROLLER BEARINGS (INCH DESIGN)

Bore Diameter 430.212 – 476.250 mm

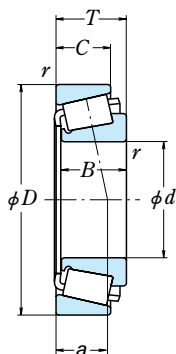

<i>d</i>	Boundary Dimensions (mm/inch)				CONE r CUP		Basic Load Ratings			
	<i>D</i>	<i>T</i>	<i>B</i>	<i>C</i>	r min.	CUP	C_r (kN)	C_{0r} (kN)	C_r (kgf)	C_{0r} (kgf)
430.212 16.9375	603.250 23.7500	76.200 3.0000	73.025 2.8750	50.800 2.0000	6.4	6.4	1 240	2 500	126 000	255 000
431.800 17.0000	533.400 21.0000	46.038 1.8125	46.038 1.8125	34.925 1.3750	3.3	3.3	580	1 380	59 500	141 000
	552.450 21.7500	44.450 1.7500	44.450 1.7500	31.750 1.2500	3.3	3.3	610	1 480	62 000	151 000
	565.150 22.2500	44.450 1.7500	44.450 1.7500	31.750 1.2500	3.3	3.3	610	1 480	62 000	151 000
	571.500 22.5000	74.612 2.9375	74.612 2.9375	52.388 2.0625	3.3	3.3	1 080	2 350	110 000	240 000
	603.250 23.7500	76.200 3.0000	73.025 2.8750	50.800 2.0000	6.4	6.4	1 240	2 500	126 000	255 000
	673.100 26.5000	88.900 3.5000	87.833 3.4580	60.325 2.3750	6.4	3.3	1 750	3 100	179 000	315 000
447.675 17.6250	552.450 21.7500	44.450 1.7500	44.450 1.7500	31.750 1.2500	3.3	3.3	610	1 480	62 000	151 000
	565.150 22.2500	44.450 1.7500	44.450 1.7500	31.750 1.2500	3.3	3.3	610	1 480	62 000	151 000
	635.000 25.0000	120.650 4.7500	120.650 4.7500	95.250 3.7500	6.4	6.4	1 900	4 350	194 000	440 000
450.850 17.7500	603.250 23.7500	85.725 3.3750	84.138 3.3125	60.325 2.3750	6.4	3.3	1 310	2 900	134 000	296 000
457.200 18.0000	573.088 22.5625	74.612 2.9375	74.612 2.9375	57.150 2.2500	6.4	6.4	1 020	2 610	104 000	267 000
	596.900 23.5000	76.200 3.0000	73.025 2.8750	53.975 2.1250	9.5	3.3	1 040	2 360	106 000	241 000
	603.250 23.7500	85.725 3.3750	84.138 3.3125	60.325 2.3750	6.4	3.3	1 310	2 900	134 000	296 000
	660.400 26.0000	91.280 3.5937	85.725 3.3750	62.705 2.4687	10.4	6.4	1 550	2 780	158 000	284 000
476.250 18.7500	565.150 22.2500	41.275 1.6250	41.275 1.6250	31.750 1.2500	3.3	3.3	535	1 340	54 500	136 000

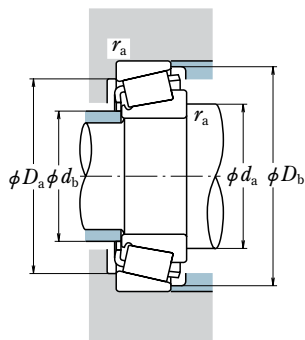

Dynamic Equivalent Load

$$P = XF_r + YF_a$$

$F_a/F_r \leq e$		$F_a/F_r > e$	
X	Y	X	Y
1	0	0.4	Y_1

Static Equivalent Load

$$P_0 = 0.5F_r + Y_0F_a$$

When $F_r > 0.5F_r + Y_0F_a$, use $P_0 = F_r$

The values of e , Y_1 , and Y_0 are given in the table below.

Bearing Numbers	Abutment and Fillet Dimensions (mm)						Eff. Load Centers (mm) a	Constant e	Axial Load Factors		Mass (kg)
	d_a	d_b	D_a	D_b	CONE r_a max.	CUP r_a			Y_1	Y_0	
EE241693 / 242375	479	457	564	585	6.4	6.4	122.1	0.52	1.1	0.63	62
80385 / 80325	458	447	511	521	3.3	3.3	69.3	0.31	2.0	1.1	20.8
80170 / 80217	467	456	530	538	3.3	3.3	71.0	0.32	1.9	1.0	25.8
80170 / 80222	467	456	536	545	3.3	3.3	71.0	0.32	1.9	1.0	28.6
LM869448 / LM869410	471	448	539	560	3.3	3.3	122.6	0.55	1.1	0.60	47.9
EE241701 / 242375	480	458	564	585	6.4	6.4	122.1	0.52	1.1	0.63	61.4
EE571703 / 572650	491	469	629	647	6.4	3.3	110.0	0.40	1.5	0.83	108
80176 / 80217	475	464	530	538	3.3	3.3	71.0	0.32	1.9	1.0	22
80176 / 80222	475	464	536	545	3.3	3.3	71.0	0.32	1.9	1.0	24.8
M270749 / M270710	502	474	591	617	6.4	6.4	114.6	0.33	1.8	0.99	117
LM770945 / LM770910	496	471	570	590	6.4	3.3	115.9	0.45	1.3	0.73	62.5
L570649 / L570610	493	472	542	562	6.4	6.4	101.2	0.40	1.5	0.83	42
EE244180 / 244235	500	475	565	580	9.5	3.3	102.0	0.40	1.5	0.82	49.9
LM770949 / LM770910	499	474	570	590	6.4	3.3	115.9	0.45	1.3	0.73	59.5
EE737181 / 737260	507	479	615	636	10.4	6.4	106.9	0.37	1.6	0.88	86.2
LL771948 / LL771911	502	489	545	557	3.3	3.3	100.2	0.47	1.3	0.70	18.2

SINGLE-ROW TAPERED ROLLER BEARINGS (INCH DESIGN)

Bore Diameter 479.425 – 539.750 mm

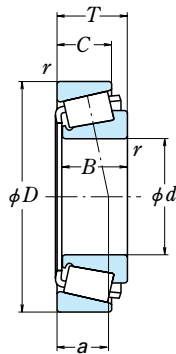

<i>d</i>	<i>D</i>	Boundary Dimensions (mm/inch)			<i>C</i>	CONE <i>r</i> CUP		Basic Load Ratings			
		<i>T</i>	<i>B</i>	<i>B'</i>		min.		(kN)	(kgf)		
								<i>C_r</i>	<i>C_{0r}</i>	<i>C_r</i>	<i>C_{0r}</i>
479.425 18.8750	679.450 26.7500	128.588 5.0625	128.588 5.0625	101.600 4.0000	6.4	6.4	2 800	6 400	285 000	650 000	
482.600 19.0000	615.950 24.2500	53.975 2.1250	46.038 1.8125	41.275 1.6250	3.3	3.3	780	1 700	79 500	173 000	
	615.950 24.2500	85.725 3.3750	85.725 3.3750	66.675 2.6250	6.4	6.4	1 390	3 450	142 000	350 000	
	634.873 24.9950	80.962 3.1875	80.962 3.1875	63.500 2.5000	6.4	3.3	1 340	3 300	136 000	335 000	
488.671 19.2390	660.400 26.0000	93.662 3.6875	94.458 3.7188	69.850 2.7500	6.4	6.4	1 700	3 800	174 000	385 000	
488.950 19.2500	634.873 24.9950	84.138 3.3125	84.138 3.3125	61.912 2.4375	6.4	3.3	1 370	3 200	140 000	325 000	
	660.400 26.0000	93.662 3.6875	94.458 3.7188	69.850 2.7500	6.4	6.4	1 700	3 800	174 000	385 000	
489.026 19.2530	634.873 24.9950	80.962 3.1875	80.962 3.1875	63.500 2.5000	6.4	3.3	1 340	3 300	136 000	335 000	
498.475 19.6250	634.873 24.9950	80.962 3.1875	80.962 3.1875	63.500 2.5000	6.4	3.3	1 340	3 300	136 000	335 000	
505.968 19.9200	736.600 29.0000	88.900 3.5000	81.758 3.2188	53.975 2.1250	6.4	3.3	1 620	3 400	165 000	345 000	
508.000 20.0000	736.600 29.0000	88.900 3.5000	81.758 3.2188	53.975 2.1250	6.4	3.3	1 620	3 400	165 000	345 000	
514.350 20.2500	736.600 29.0000	88.900 3.5000	81.758 3.2188	53.975 2.1250	6.4	3.3	1 620	3 400	165 000	345 000	
520.700 20.5000	736.600 29.0000	88.900 3.5000	81.758 3.2188	53.975 2.1250	6.4	3.3	1 620	3 400	165 000	345 000	
533.400 21.0000	635.000 25.0000	50.800 2.0000	50.800 2.0000	38.100 1.5000	6.4	6.4	705	1 800	72 000	183 000	
	784.225 30.8750	88.900 3.5000	82.550 3.2500	53.975 2.1250	6.4	6.4	1 750	3 500	179 000	355 000	
539.750 21.2500	635.000 25.0000	50.800 2.0000	50.800 2.0000	38.100 1.5000	6.4	6.4	705	1 800	72 000	183 000	

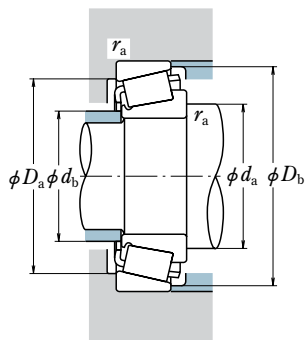

Dynamic Equivalent Load

$$P = XF_r + YF_a$$

$F_a/F_r \leq e$		$F_a/F_r > e$	
X	Y	X	Y
1	0	0.4	Y_1

Static Equivalent Load

$$P_0 = 0.5F_r + Y_0F_a$$

When $F_r > 0.5F_r + Y_0F_a$, use $P_0 = F_r$

The values of e , Y_1 , and Y_0 are given in the table below.

Bearing Numbers	Abutment and Fillet Dimensions (mm)						Eff. Load Centers (mm) a	Constant e	Axial Load Factors		Mass (kg)
	d_a	d_b	D_a	D_b	CONE r_a max.	CUP r_a			Y_1	Y_0	
M272749 / M272710	535	504	635	663	6.4	6.4	121.1	0.34	1.8	0.97	148
80480 / 80425	516	503	588	600	3.3	3.3	90.0	0.35	1.7	0.95	35.2
LM272249 / LM272210	522	501	582	604	6.4	6.4	106.1	0.37	1.6	0.88	59.8
EE243190 / 243250	530	508	606	622	6.4	3.3	99.1	0.34	1.8	0.97	67.6
EE640191 / 640260	535	511	624	643	6.4	6.4	98.2	0.31	2.0	1.1	87.7
LM772748 / LM772710	532	508	602	623	6.4	3.3	124.7	0.47	1.3	0.70	63.9
EE640192 / 640260	535	511	624	643	6.4	6.4	98.2	0.31	2.0	1.1	87.6
EE243192 / 243250	533	512	606	622	6.4	3.3	99.1	0.34	1.8	0.97	64.5
EE243196 / 243250	538	516	606	622	6.4	3.3	99.1	0.34	1.8	0.97	59.9
EE981992 / 982900	571	547	693	712	6.4	3.3	134.9	0.48	1.3	0.69	114
EE982003 / 982900	572	548	693	712	6.4	3.3	134.9	0.48	1.3	0.69	113
EE982028 / 982900	576	551	693	712	6.4	3.3	134.9	0.48	1.3	0.69	109
EE982051 / 982900	579	554	693	712	6.4	3.3	134.9	0.48	1.3	0.69	106
LL575343 / LL575310	566	549	610	626	6.4	6.4	101.4	0.40	1.5	0.82	28.2
EE522102 / 523087	596	573	730	752	6.4	6.4	139.5	0.48	1.3	0.69	129
LL575349 / LL575310	569	552	610	626	6.4	6.4	101.4	0.40	1.5	0.82	26.1

SINGLE-ROW TAPERED ROLLER BEARINGS (INCH DESIGN)

Bore Diameter 546.100 – 660.400 mm

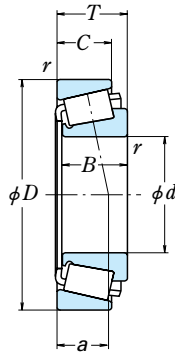

<i>d</i>	Boundary Dimensions (mm/inch)				CONE <i>r</i> CUP		Basic Load Ratings (kN) (kgf)			
	<i>D</i>	<i>T</i>	<i>B</i>	<i>C</i>	<i>r</i> min.	CUP	<i>C_r</i>	<i>C_{0r}</i>	<i>C_r</i>	<i>C_{0r}</i>
546.100 21.5000	736.600 29.0000	76.200 3.0000	76.200 3.0000	50.800 2.0000	6.4	6.4	1 280	2 590	130 000	264 000
549.275 21.6250	692.150 27.2500	80.962 3.1875	80.962 3.1875	61.912 2.4375	6.4	6.4	1 430	3 550	146 000	365 000
558.800 22.0000	736.600 29.0000	76.200 3.0000	76.200 3.0000	50.800 2.0000	6.4	6.4	1 280	2 590	130 000	264 000
	736.600 29.0000	88.108 3.4688	88.108 3.4688	63.500 2.5000	6.4	6.4	1 750	3 900	178 000	395 000
	736.600 29.0000	104.775 4.1250	104.775 4.1250	80.962 3.1875	6.4	6.4	2 300	5 600	235 000	575 000
571.500 22.5000	812.800 32.0000	155.575 6.1250	155.575 6.1250	120.650 4.7500	6.4	6.4	4 000	9 300	410 000	950 000
584.200 23.0000	685.800 27.0000	49.212 1.9375	49.212 1.9375	34.925 1.3750	3.5	3.3	735	1 970	75 000	200 000
596.900 23.5000	685.800 27.0000	31.750 1.2500	31.750 1.2500	25.400 1.0000	3.5	3.3	380	995	38 500	101 000
602.945 23.7380	787.400 31.0000	93.662 3.6875	93.662 3.6875	69.850 2.7500	6.4	6.4	2 000	4 800	204 000	490 000
607.720 23.9260	787.400 31.0000	93.662 3.6875	93.662 3.6875	69.850 2.7500	6.4	6.4	2 000	4 800	204 000	490 000
609.600 24.0000	762.000 30.0000	95.250 3.7500	92.075 3.6250	71.438 2.8125	6.4	6.4	1 780	4 700	181 000	480 000
	774.700 30.5000	85.725 3.3750	79.375 3.1250	60.320 2.3748	6.4	6.4	1 780	4 250	182 000	430 000
	787.400 31.0000	93.662 3.6875	93.662 3.6875	69.850 2.7500	6.4	6.4	2 000	4 800	204 000	490 000
635.000 25.0000	736.600 29.0000	57.150 2.2500	53.975 2.1250	41.275 1.6250	3.3	3.3	870	2 500	89 000	255 000
660.400 26.0000	812.800 32.0000	95.250 3.7500	95.250 3.7500	73.025 2.8750	6.4	6.4	2 200	5 900	224 000	600 000
	854.075 33.6250	85.725 3.3750	85.468 3.3649	60.325 2.3750	9.7	6.4	2 000	4 650	204 000	475 000

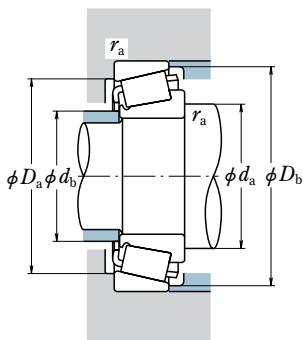

Dynamic Equivalent Load

$$P = XF_r + YF_a$$

$F_a/F_r \leq e$		$F_a/F_r > e$	
X	Y	X	Y
1	0	0.4	Y_1

Static Equivalent Load

$$P_0 = 0.5F_r + Y_0F_a$$

When $F_r > 0.5F_r + Y_0F_a$, use $P_0 = F_r$

The values of e , Y_1 , and Y_0 are given in the table below.

Bearing Numbers	Abutment and Fillet Dimensions (mm)						Eff. Load Centers (mm) \bar{a}	Constant e	Axial Load Factors		Mass (kg) approx.
	d_a	d_b	D_a	D_b	CONE r_a max.	CUP r_a			Y_1	Y_0	
EE542215 / 542290	598	574	695	715	6.4	6.4	142.2	0.51	1.2	0.65	79.7
L476549 / L476510	591	568	658	679	6.4	6.4	113.1	0.38	1.6	0.88	67.4
EE542220 / 542290	604	581	695	715	6.4	6.4	142.2	0.51	1.2	0.65	73.2
EE843220 / 843290	606	585	699	718	6.4	6.4	111.3	0.34	1.8	0.97	93.7
LM377449 / LM377410	607	581	696	720	6.4	6.4	120.7	0.35	1.7	0.95	118
M278749 / M278710	634	601	759	790	6.4	6.4	143.6	0.33	1.8	0.99	256
LL778149 / LL778110	613	599	663	675	3.5	3.3	114.3	0.44	1.4	0.75	29.6
680235 / 680270	621	610	664	675	3.5	3.3	124.9	0.52	1.1	0.63	17.4
EE649237 / 649310	655	629	749	771	6.4	6.4	129.2	0.37	1.6	0.89	115
EE649239 / 649310	658	631	749	771	6.4	6.4	129.2	0.37	1.6	0.89	111
L879947 / L879910	656	627	722	750	6.4	6.4	152.9	0.49	1.2	0.68	93.3
L580049 / L580010	654	634	737	755	6.4	6.4	130.5	0.40	1.5	0.82	90.1
EE649240 / 649310	659	632	749	771	6.4	6.4	129.2	0.37	1.6	0.89	110
80780 / 80720	664	648	712	726	3.3	3.3	125.0	0.44	1.4	0.75	36.6
L281148 / L281110	701	678	778	799	6.4	6.4	123.1	0.33	1.8	0.99	105
EE749260 / 749336	712	690	813	831	9.7	6.4	124.5	0.35	1.7	0.94	119

SINGLE-ROW TAPERED ROLLER BEARINGS (INCH DESIGN)

Bore Diameter 673.100 – 1 270.000 mm

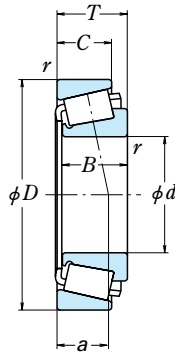

d	Boundary Dimensions (mm/inch)					CONE r CUP		Basic Load Ratings			
	D	T	B	C	r min.	CUP	C_r (kN)	C_{0r} (kgf)	C_r (kN)	C_{0r} (kgf)	
673.100 26.5000	793.750 31.2500	66.675 2.6250	61.912 2.4375	49.212 1.9375	6.4	6.4	995	2 660	102 000	271 000	
685.800 27.0000	876.300 34.5000	93.662 3.6875	92.075 3.6250	69.850 2.7500	6.4	6.4	2 160	5 550	220 000	565 000	
711.200 28.0000	914.400 36.0000	85.725 3.3750	82.550 3.2500	60.325 2.3750	6.4	6.4	1 870	4 800	191 000	490 000	
723.900 28.5000	914.400 36.0000	84.138 3.3125	80.962 3.1875	60.325 2.3750	3.3	6.4	1 870	4 800	191 000	490 000	
749.300 29.5000	990.600 39.0000	159.500 6.2795	160.338 6.3125	123.000 4.8425	6.4	6.4	4 400	11 700	450 000	1 200 000	
762.000 30.0000	889.000 35.0000	63.500 2.5000	63.500 2.5000	50.800 2.0000	3.3	3.3	1 160	3 450	119 000	350 000	
	889.000 35.0000	69.850 2.7500	69.850 2.7500	50.800 2.0000	3.3	3.3	1 160	3 450	119 000	350 000	
	965.200 38.0000	93.662 3.6875	80.962 3.1875	66.675 2.6250	6.4	3.3	2 100	5 200	214 000	530 000	
774.700 30.5000	965.200 38.0000	93.662 3.6875	80.962 3.1875	66.675 2.6250	6.4	3.3	2 100	5 200	214 000	530 000	
838.200 33.0000	1 041.400 41.0000	93.662 3.6875	88.900 3.5000	66.675 2.6250	6.4	6.4	2 380	6 350	243 000	650 000	
977.900 38.5000	1 130.300 44.5000	66.675 2.6250	63.500 2.5000	47.625 1.8750	6.4	6.4	1 460	4 350	149 000	445 000	
1 066.800 42.0000	1 219.200 48.0000	65.088 2.5625	65.088 2.5625	42.862 1.6875	3.3	3.3	1 520	4 750	155 000	485 000	
1 092.200 43.0000	1 320.800 52.0000	95.250 3.7500	88.900 3.5000	69.850 2.7500	6.4	6.4	2 730	7 650	278 000	780 000	
1 155.700 45.5000	1 435.100 56.5000	120.650 4.7500	120.650 4.7500	95.250 3.7500	6.4	6.4	4 150	12 000	420 000	1 220 000	
1 270.000 50.0000	1 435.100 56.5000	69.850 2.7500	65.088 2.5625	47.625 1.8750	6.4	6.4	1 630	5 550	167 000	565 000	

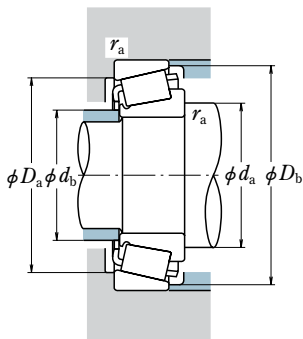

Dynamic Equivalent Load

$$P = XF_r + YF_a$$

$F_a/F_r \leq e$		$F_a/F_r > e$	
X	Y	X	Y
1	0	0.4	Y_1

Static Equivalent Load

$$P_0 = 0.5F_r + Y_0F_a$$

When $F_r > 0.5F_r + Y_0F_a$, use $P_0 = F_r$

The values of e , Y_1 , and Y_0 are given in the table below.

Bearing Numbers	Abutment and Fillet Dimensions (mm)						Eff. Load Centers (mm) a	Constant e	Axial Load Factors		Mass (kg)
	d_a	d_b	D_a	D_b	CONE r_a max.	CUP r_a			Y_1	Y_0	
LL481448 / LL481411	708	691	764	781	6.4	6.4	119.7	0.36	1.7	0.92	52
EE655270 / 655345	737	712	832	857	6.4	6.4	149.9	0.42	1.4	0.79	134
EE755280 / 755360	767	746	870	891	6.4	6.4	140.5	0.38	1.6	0.87	136
EE755285 / 755360	770	752	870	891	3.3	6.4	140.5	0.38	1.6	0.87	126
LM283649 / LM283610	815	782	938	969	6.4	6.4	165.2	0.33	1.8	0.99	329
EE175301 / 175350	797	780	861	876	3.3	3.3	131.4	0.38	1.6	0.87	64.4
LL483449 / LL483418	797	780	861	875	3.3	3.3	133.8	0.38	1.6	0.87	68.1
EE752300 / 752380	815	793	926	943	6.4	3.3	158.8	0.40	1.5	0.83	147
EE752305 / 752380	822	800	926	943	6.4	3.3	158.8	0.40	1.5	0.83	137
EE763330 / 763410	892	866	995	1018	6.4	6.4	178.1	0.44	1.4	0.75	171
LL687949 / LL687910	1019	1002	1095	1112	6.4	6.4	182.9	0.43	1.4	0.76	101
LL788349 / LL788310	1106	1090	1187	1202	3.3	3.3	209.0	0.47	1.3	0.70	108
EE776430 / 776520	1153	1128	1269	1301	6.4	6.4	270.7	0.57	1.1	0.58	249
EE277455 / 277565	1227	1199	1377	1403	6.4	6.4	207.3	0.36	1.7	0.92	431
LL889049 / LL889010	1315	1294	1392	1413	6.4	6.4	285.4	0.57	1.1	0.58	144

DOUBLE-ROW TAPERED ROLLER BEARINGS

KBE (TDO) Type, Double Cup, Single Cones

Bore Diameter 100 – 101.600 mm

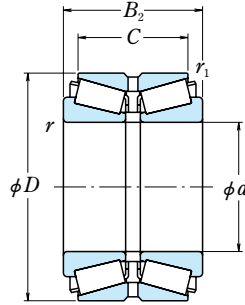

d	Boundary Dimensions (mm/inch)					Basic Load Ratings			
	D	B_2	C	r min.	r_1 min.	(kN)		(kgf)	
						C_r	C_{0r}	C_r	C_{0r}
100	140	60	50	0.6	0.3	201	410	20 500	42 000
	165	52	46	2.5	0.6	222	340	22 700	35 000
	165	65	52	2.5	0.6	295	480	30 000	49 000
	180	81	64	3	1	435	665	44 500	68 000
	180	81	65	3	1	435	665	44 500	68 000
	180	82	65	3	1	395	570	40 000	58 500
	180	82	66	3	1	435	665	44 500	68 000
	180	83	67	3	1	435	665	44 500	68 000
	180	105	85	3	1	555	905	56 500	92 000
	180	107	87	3	1	555	905	56 500	92 000
	180	110	90	3	1	555	905	56 500	92 000
	215	112	87	4	1	725	1 050	74 000	107 000
	215	143	118	3	1.5	975	1 620	99 500	165 000
	100.000 3.9370	180.975 7.1250	104.775 4.1250	85.725 3.3750	3.5	1.5	440	750	45 000
101.600 4.0000		161.925 6.3750	82.548 3.2499	61.912 2.4375	3.5	0.8	310	570	31 500
	168.275 6.6250	92.075 3.6250	69.850 2.7500	3.5	0.8	380	685	39 000	70 000
	180.000 7.0866	104.775 4.1250	85.725 3.3750	3.5	0.8	440	750	45 000	76 500
	180.975 7.1250	104.775 4.1250	85.725 3.3750	3.5	1.5	440	750	45 000	76 500
	190.500 7.5000	127.000 5.0000	101.600 4.0000	8.0	1.5	605	1 000	61 500	102 000
	190.500 7.5000	127.000 5.0000	104.775 4.1250	8.0	1.5	665	1 040	68 000	107 000
	200.025 7.8750	115.888 4.5625	80.216 3.1581	3.5	2.3	540	850	55 000	86 500
	212.725 8.3750	142.875 5.6250	117.475 4.6250	7.0	1.5	975	1 620	99 500	165 000
	212.725 8.3750	142.875 5.6250	117.475 4.6250	7.0	1.5	820	1 400	83 500	143 000

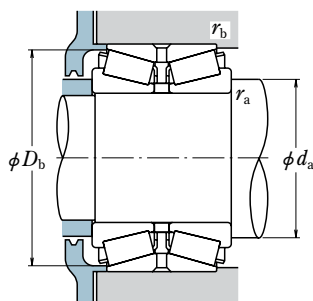

Dynamic Equivalent Load

$$P = XF_r + YF_a$$

$F_a/F_r \leq e$		$F_a/F_r > e$	
X	Y	X	Y
1	Y_3	0.67	Y_2

Static Equivalent Load

$$P_0 = F_r + Y_0 F_a$$

The values of e , Y_2 , Y_3 , and Y_0 are given in the table below.

Bearing Numbers	Abutment and Fillet Dimensions (mm)				Constant e	Axial Load Factors			Mass (kg) approx.
	d_a	D_b	r_a max.	r_b max.		Y_2	Y_3	Y_0	
100KBE1401+L	111	136	0.6	0.3	0.33	3.1	2.0	2.0	2.6
100KBE31+L	117	158	2	0.6	0.33	3.0	2.0	2.0	4.0
100KBE031+L	118	158	2	0.6	0.39	2.6	1.7	1.7	5.0
HR100KBE1805+L	120	172	2.5	1	0.42	2.4	1.6	1.6	8.2
HR100KBE042+L	120	172	2.5	1	0.42	2.4	1.6	1.6	8.1
100KBE1806+L	121	172	2.5	1	0.42	2.4	1.6	1.6	7.8
HR100KBE1801+L	120	172	2.5	1	0.42	2.4	1.6	1.6	8.2
HR100KBE42+L	120	172	2.5	1	0.42	2.4	1.6	1.6	8.7
HR100KBE1802+L	121	174	2.5	1	0.42	2.4	1.6	1.6	10.6
HR100KBE52X+L	121	174	2.5	1	0.42	2.4	1.6	1.6	10.7
HR100KBE1804+L	121	174	2.5	1	0.42	2.4	1.6	1.6	11.0
HR100KBE043+L	130	204	3	1	0.35	2.9	2.0	1.9	18.1
100KBE2101+L	132	206	2.5	1.5	0.33	3.1	2.1	2.0	24.6
* 783 / 774D+L	123	171	3.5	1.5	0.39	2.6	1.8	1.7	10.6
* 52400 / 52637D+L	120	155	3.5	0.8	0.47	2.1	1.4	1.4	5.7
* 687 / 672D+L	121	161	3.5	0.8	0.47	2.1	1.4	1.4	7.3
* 780 / 773D+L	124	171	3.5	0.8	0.39	2.6	1.8	1.7	10.2
* 780 / 774D+L	124	171	3.5	1.5	0.39	2.6	1.8	1.7	10.4
* 861 / 854D+L	130	180	8.0	1.5	0.33	3.0	2.0	2.0	14.4
* HH221449 / HH221410D+L	131	183	8.0	1.5	0.33	3.0	2.0	2.0	14.3
* 98400 / 98789D+L	132	190	3.5	2.3	0.63	1.6	1.1	1.0	14.8
* HH224335 / HH224310D+L	137	205	7.0	1.5	0.33	3.1	2.1	2.0	23.3
* 941 / 932D+L	136	201	7.0	1.5	0.33	3.1	2.1	2.0	23.3

Note * Bearings marked * are inch design.

DOUBLE-ROW TAPERED ROLLER BEARINGS

KBE (TDO) Type, Double Cup, Single Cones

Bore Diameter 104.775 – 110 mm

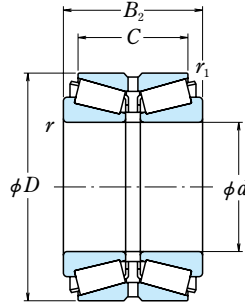

<i>d</i>	Boundary Dimensions (mm/inch)				Basic Load Ratings				
	<i>D</i>	<i>B</i> ₂	<i>C</i>	<i>r</i> min.	<i>r</i> ₁ min.	<i>C</i> _r (kN)	<i>C</i> _{0r} (kgf)	<i>C</i> _r (kgf)	<i>C</i> _{0r} (kgf)
104.775 4.1250	180.000 7.0866	104.775 4.1250	85.725 3.3750	3.5	0.8	440	750	45 000	76 500
	180.975 7.1250	104.775 4.1250	85.725 3.3750	3.5	1.5	440	750	45 000	76 500
	180.975 7.1250	104.775 4.1250	85.725 3.3750	6.4	1.5	440	750	45 000	76 500
	190.500 7.5000	106.362 4.1875	80.962 3.1875	3.5	1.5	510	925	52 000	94 500
105	190	88	70	3	1	480	735	49 000	65 000
	190	115	95	3	1	630	1 020	63 500	104 000
	190	117	96	3	1	580	1 020	63 500	104 000
	225	116	91	4	1	780	1 130	79 500	115 000
106.362 4.1875	165.100 6.5000	82.550 3.2500	63.500 2.5000	3.5	0.8	335	645	34 000	65 500
	107.950 4.2500	146.050 5.7500	49.212 1.9375	39.688 1.5625	1.5	0.8	147	330	15 000
165.100 6.5000		82.550 3.2500	63.500 2.5000	3.5	0.8	335	645	34 000	65 500
190.500 7.5000		106.362 4.1875	80.962 3.1875	3.5	1.5	510	925	52 000	94 500
212.725 8.3750		142.875 5.6250	117.475 4.6250	8.0	1.5	975	1 620	99 500	165 000
109.992 4.3288	212.725 8.3750	142.875 5.6250	117.475 4.6250	8.0	1.5	820	1 400	83 500	143 000
	234.950 9.2500	111.125 4.3750	82.550 3.2500	6.4	1.5	610	840	62 500	85 500
	190.500 7.5000	106.362 4.1875	80.962 3.1875	3.5	1.5	510	925	52 000	94 500
109.992 4.3304	177.800 7.0000	92.075 3.6250	69.850 2.7500	3.5	0.8	400	750	40 500	76 500
	110	150	80	63	0.6	0.3	210	450	21 500
180		56	50	2.5	0.6	264	400	26 900	41 000
180		70	56	2.5	0.6	340	555	34 500	56 500

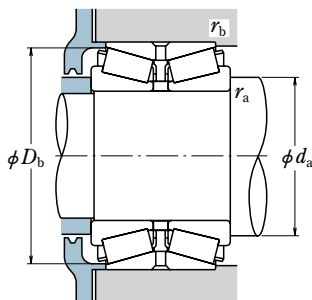

Dynamic Equivalent Load

$$P = X F_r + Y F_a$$

$F_a/F_r \leq e$		$F_a/F_r > e$	
X	Y	X	Y
1	Y_3	0.67	Y_2

Static Equivalent Load

$$P_0 = F_r + Y_0 F_a$$

The values of e , Y_2 , Y_3 , and Y_0 are given in the table below.

Bearing Numbers	Abutment and Fillet Dimensions (mm)				Constant e	Axial Load Factors			Mass (kg) approx.
	d_a	D_b	r_a max.	r_b max.		Y_2	Y_3	Y_0	
* 782 / 773D+L	125	171	3.5	0.8	0.39	2.6	1.8	1.7	9.7
* 782 / 774D+L	125	171	3.5	1.5	0.39	2.6	1.8	1.7	9.9
* 786 / 774D+L	128	171	6.4	1.5	0.39	2.6	1.8	1.7	9.9
* 71412 / 71751D+L	131	182	3.5	1.5	0.42	2.4	1.6	1.6	12.2
HR105KBE42X+L	127	182	2.5	1	0.42	2.4	1.6	1.6	9.8
HR105KBE52+L	128	183	2.5	1	0.42	2.4	1.6	1.6	13.1
HR105KBE1902+L	128	183	2.5	1	0.42	2.4	1.6	1.6	13.4
HR105KBE043+L	135	214	3	1	0.35	2.9	2.0	1.9	20.4
* 56418 / 56650D+L	126	160	3.5	0.8	0.50	2.0	1.4	1.3	5.9
* L521949 / L521910D+L	120	141	1.5	0.8	0.39	2.6	1.7	1.7	2.2
* 56425 / 56650D+L	127	160	3.5	0.8	0.50	2.0	1.4	1.3	5.7
* 71425 / 71751D+L	133	182	3.5	1.5	0.42	2.4	1.6	1.6	11.8
* HH224340 / HH224310D+L	142	205	8.0	1.5	0.33	3.1	2.1	2.0	22.1
* 936 / 932D+L	140	201	8.0	1.5	0.33	3.1	2.1	2.0	22.1
* EE342043 / 342091D+L	144	222	6.4	1.5	0.43	2.3	1.6	1.5	20
* 71432 / 71751D+L	134	182	3.5	1.5	0.42	2.4	1.6	1.6	11.5
* 64433 / 64700D+L	132	173	3.5	0.8	0.52	1.9	1.3	1.3	8.0
110KBE1501+L	121	147	0.6	0.3	0.36	2.8	1.9	1.9	3.6
110KBE31+L	129	174	2	0.6	0.39	2.6	1.7	1.7	5.1
110KBE031+L	129	174	2	0.6	0.39	2.6	1.7	1.7	6.3

Note * Bearings marked * are inch design.

DOUBLE-ROW TAPERED ROLLER BEARINGS

KBE (TDO) Type, Double Cup, Single Cones

Bore Diameter 110 – 120 mm

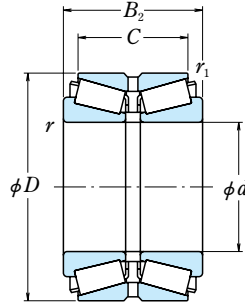

<i>d</i>	Boundary Dimensions (mm/inch)					Basic Load Ratings			
	<i>D</i>	<i>B</i> ₂	<i>C</i>	<i>r</i> min.	<i>r</i> ₁ min.	(kN)		(kgf)	
						<i>C</i> _r	<i>C</i> _{0r}	<i>C</i> _r	<i>C</i> _{0r}
110	200	90	72	3	1	590	840	55 000	85 500
	200	92	74	3	1	590	840	55 000	85 500
	200	120	100	3	1	685	1 130	69 500	115 000
	200	121	101	3	1	685	1 130	69 500	115 000
	200	125	105	3	1	610	965	62 000	98 500
	220	145	115	4	1	820	1 350	83 500	138 000
240	118	93	4	1	830	1 190	84 500	121 000	
111.125 4.3750	190.500 7.5000	106.362 4.1875	80.962 3.1875	3.5	1.5	510	925	52 000	94 500
114.300 4.5000	177.800 7.0000	92.075 3.6250	69.850 2.7500	3.5	0.8	400	750	40 500	76 500
	212.725 8.3750	142.875 5.6250	117.475 4.6250	7.0	1.5	975	1 620	99 500	165 000
	212.725 8.3750	142.875 5.6250	117.475 4.6250	7.0	1.5	820	1 400	83 500	143 000
114.976 4.5266	212.725 8.3750	142.875 5.6250	117.475 4.6250	7.0	1.5	975	1 620	99 500	165 000
115.000 4.5276	177.800 7.0000	92.075 3.6250	69.850 2.7500	3.5	0.8	400	750	40 500	76 500
120	165	68	56	1.5	0.6	236	495	24 100	50 500
	180	46	41	2.5	0.6	184	296	18 800	30 000
	180	58	46	2.5	0.6	260	450	26 500	46 000
	200	62	55	2.5	0.6	310	500	32 000	51 000
	200	78	62	2.5	0.6	415	690	42 000	70 000
	200	100	84	2.5	0.6	515	885	52 500	90 500
	215	94	75	3	1	540	800	55 000	81 500
	215	97	78	3	1	575	900	58 500	92 000
	215	132	109	3	1	750	1 270	76 500	130 000
	260	128	101	4	1	915	1 310	93 500	134 000
	260	188	145	4	1	1 320	2 110	135 000	215 000
	280	185	155	5	1.5	1 180	1 770	120 000	180 000

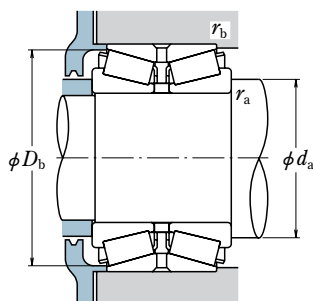

Dynamic Equivalent Load

$$P = X F_r + Y F_a$$

$F_a/F_r \leq e$		$F_a/F_r > e$	
X	Y	X	Y
1	Y_3	0.67	Y_2

Static Equivalent Load

$$P_0 = F_r + Y_0 F_a$$

The values of e , Y_2 , Y_3 , and Y_0 are given in the table below.

Bearing Numbers	Abutment and Fillet Dimensions (mm)				Constant e	Axial Load Factors			Mass (kg) approx.
	d_a	D_b	r_a max.	r_b max.		Y_2	Y_3	Y_0	
HR110KBE42+L	133	192	2.5	1	0.42	2.4	1.6	1.6	11.2
HR110KBE42X+L	133	192	2.5	1	0.42	2.4	1.6	1.6	11.5
HR110KBE2001+L	134	193	2.5	1	0.42	2.4	1.6	1.6	15.4
HR110KBE52X+L	134	193	2.5	1	0.42	2.4	1.6	1.6	15.2
110KBE2002+L	134	194	2.5	1	0.42	2.4	1.6	1.6	14.8
110KBE2201+L	142	211	3	1	0.37	2.7	1.8	1.8	23.6
HR110KBE043+L	143	228	3	1	0.35	2.9	2.0	1.9	23.6
* 71437 / 71751D+L	135	182	3.5	1.5	0.42	2.4	1.6	1.6	11.3
* 64450 / 64700D+L	135	173	3.5	0.8	0.52	1.9	1.3	1.3	7.5
* HH224346 / HH224310D+L	144	205	7.0	1.5	0.33	3.1	2.1	2.0	20.9
* 938 / 932D+L	142	201	7.0	1.5	0.33	3.1	2.1	2.0	20.9
* HH224349 / HH224310D+L	144	205	7.0	1.5	0.33	3.1	2.1	2.0	20.8
# 64452 / 64700D+L	135	173	3.5	0.8	0.52	1.9	1.3	1.3	7.4
120KBE1601+L	134	161	1	0.5	0.40	2.5	1.7	1.6	3.9
120KBE30+L	137	174	2	0.6	0.40	2.5	1.7	1.6	3.7
120KBE030+L	137	174	2	0.6	0.39	2.6	1.7	1.7	4.6
120KBE31+L	142	192	2	0.6	0.39	2.6	1.7	1.7	7.3
120KBE031+L	141	192	2	0.6	0.39	2.6	1.7	1.7	8.9
120KBE2001+L	142	194	2	0.6	0.37	2.7	1.8	1.8	11.3
120KBE2101+L	145	208	2.5	1	0.42	2.4	1.6	1.6	12.6
HR120KBE42X+L	144	206	2.5	1	0.44	2.3	1.6	1.5	13.7
HR120KBE52X+L	145	208	2.5	1	0.44	2.3	1.6	1.5	18.8
HR120KBE43+L	134	247	3	1	0.35	2.9	2.0	1.9	29.4
HR120KBE2601+L	155	248	3	1	0.35	2.9	2.0	1.9	44.6
120KBE2801+L	162	266	3	1.5	0.39	2.6	1.7	1.7	51.6

- Notes**
- * Bearings marked * are inch design.
 - # Bearings marked # are inch design. Bore tolerances are listed in table 2.4 on page A24, but their tolerances are negative.

DOUBLE-ROW TAPERED ROLLER BEARINGS

KBE (TDO) Type, Double Cup, Single Cones

Bore Diameter 120.000 – 128.588 mm

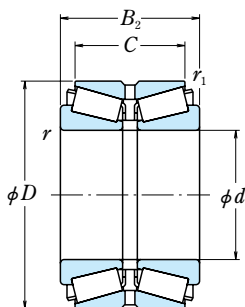

<i>d</i>	Boundary Dimensions (mm/inch)					Basic Load Ratings			
	<i>D</i>	<i>B</i> ₂	<i>C</i>	<i>r</i> min.	<i>r</i> ₁ min.	<i>C</i> _r (kN)	<i>C</i> _{0r}	<i>C</i> _r (kgf)	<i>C</i> _{0r}
120.000 4.7244	174.625 6.8750	77.788 3.0625	61.913 2.4375	3.5	0.8	365	765	37 000	78 000
120.650 4.7500	174.625 6.8750	77.788 3.0625	61.913 2.4375	3.5	0.8	365	765	37 000	78 000
	206.375 8.1250	107.950 4.2500	82.550 3.2500	3.3	0.8	545	1 060	56 000	108 000
123.825 4.8750	182.562 7.1875	85.725 3.3750	73.025 2.8750	3.5	0.8	390	885	40 000	90 500
124.943 4.9190	234.950 9.2500	142.875 5.6250	114.300 4.5000	6.4	1.5	875	1 580	89 000	161 000
125	210	110	88	4	1	560	1 030	57 000	105 000
127.000 5.0000	182.562 7.1875	85.725 3.3750	73.025 2.8750	3.5	0.8	390	885	40 000	90 500
	196.850 7.7500	101.600 4.0000	85.725 3.3750	3.5	0.8	535	1 120	54 500	115 000
	200.025 7.8750	101.600 4.0000	85.725 3.3750	3.5	0.8	535	1 120	54 500	115 000
	215.900 8.5000	106.362 4.1875	80.962 3.1875	3.5	1.5	495	985	50 500	100 000
	234.950 9.2500	142.875 5.6250	114.300 4.5000	6.4	1.5	875	1 580	89 000	161 000
	258.762 10.1875	177.800 7.0000	136.525 5.3750	9.7	1.5	975	1 600	99 000	164 000
128.588 5.0625	206.375 8.1250	107.950 4.2500	82.550 3.2500	3.3	0.8	545	1 060	56 000	108 000

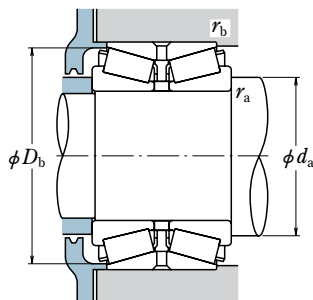

Dynamic Equivalent Load

$$P = XF_r + YF_a$$

$F_a/F_r \leq e$		$F_a/F_r > e$	
X	Y	X	Y
1	Y_3	0.67	Y_2

Static Equivalent Load

$$P_0 = F_r + Y_0 F_a$$

The values of e , Y_2 , Y_3 , and Y_0 are given in the table below.

Bearing Numbers	Abutment and Fillet Dimensions (mm)				Constant e	Axial Load Factors			Mass (kg) approx.
	d_a	D_b	r_a max.	r_b max.		Y_2	Y_3	Y_0	
# M224748 / M224710D+L	137	169	3.5	0.8	0.33	3.0	2.0	2.0	5.8
* M224749 / M224710D+L	138	169	3.5	0.8	0.33	3.0	2.0	2.0	5.7
* 795 / 792D+L	149	199	3.3	0.8	0.46	2.2	1.5	1.4	14
* 48286 / 48220D+L	143	177	3.5	0.8	0.31	3.3	2.2	2.2	7.4
* 95491 / 95927D+L	162	226	6.4	1.5	0.37	2.7	1.8	1.8	25.7
125KBE2101+L	151	202	3	1	0.43	2.3	1.6	1.5	14.5
* 48290 / 48220D+L	145	177	3.5	0.8	0.31	3.3	2.2	2.2	7.0
* 67388 / 67322D+L	150	192	3.5	0.8	0.34	2.9	2.0	1.9	11.1
* 67388 / 67325D+L	150	193	3.5	0.8	0.34	2.9	2.0	1.9	11.7
* 74500 / 74851D+L	157	208	3.5	1.5	0.49	2.1	1.4	1.4	15
* 95500 / 95927D+L	163	226	6.4	1.5	0.37	2.7	1.8	1.8	25.2
* EE153050 / 153103D+L	167	243	9.7	1.5	0.32	3.1	2.1	2.1	38
* 799 / 792D+L	153	199	3.3	0.8	0.46	2.2	1.5	1.4	12.7

Notes * Bearings marked * are inch design.
Bearings marked # are inch design. Bore tolerances are listed in table 2.4 on page A24, but their tolerances are negative.

DOUBLE-ROW TAPERED ROLLER BEARINGS

KBE (TDO) Type, Double Cup, Single Cones

Bore Diameter 130 – 133.350 mm

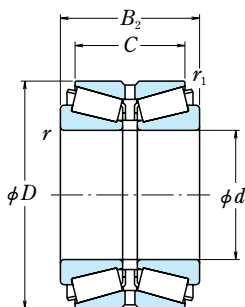

<i>d</i>	Boundary Dimensions (mm/inch)					Basic Load Ratings			
	<i>D</i>	<i>B</i> ₂	<i>C</i>	<i>r</i> min.	<i>r</i> ₁ min.	<i>C</i> _r (kN)	<i>C</i> _{0r} (kgf)	<i>C</i> _r	<i>C</i> _{0r}
130	200	52	46	2.5	0.6	266	445	27 100	45 500
	200	65	52	2.5	0.6	320	540	32 500	55 000
	210	64	57	2.5	0.6	340	530	34 500	54 000
	210	80	64	2.5	0.6	455	765	46 500	78 000
	210	109	90	2.5	0.6	550	980	56 000	100 000
	214	115	98	3	1	625	1 140	63 500	117 000
	230	98	78.5	4	1	640	1 010	65 500	103 000
	230	100	80.5	4	1	640	1 010	65 500	103 000
	230	142	114.5	4	1	850	1 480	87 000	151 000
	230	145	115	4	1	905	1 580	92 500	161 000
	230	145	117.5	4	1	905	1 580	92 500	161 000
	230	150	120	4	1	905	1 580	92 500	161 000
	235	145	115	4	1	850	1 480	87 000	151 000
	280	137	107.5	5	1.5	940	1 350	95 500	137 000
	130.000	206.375	107.950	82.550	3.5	0.8	545	1 060	56 000
5.1181	8.1250	4.2500	3.2500						
130.175	196.850	101.600	85.725	3.5	0.8	535	1 120	54 500	115 000
	7.7500	4.0000	3.3750						
	200.025	101.600	85.725	3.5	0.8	535	1 120	54 500	115 000
	7.8750	4.0000	3.3750						
	206.375	107.950	82.550	3.5	0.8	545	1 060	56 000	108 000
	8.1250	4.2500	3.2500						
133	216	106	81	3.5	1.5	495	985	50 500	100 000
133.350	177.008	57.150	47.625	1.5	0.8	213	515	21 700	52 500
	6.9688	2.2500	1.8750						
	190.500	85.725	73.025	3.5	0.8	370	880	37 500	90 000
	7.5000	3.3750	2.8750						
	196.850	101.600	85.725	3.5	0.8	535	1 120	54 500	115 000
	7.7500	4.0000	3.3750						
	196.850	101.600	85.725	8.0	0.8	535	1 120	54 500	115 000
	7.7500	4.0000	3.3750						
	200.025	101.600	85.725	3.5	0.8	535	1 120	54 500	115 000
	7.8750	4.0000	3.3750						

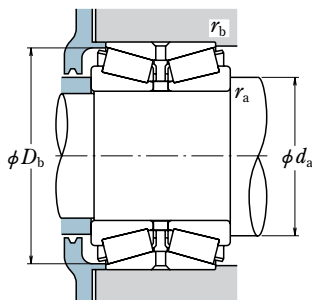

Dynamic Equivalent Load

$$P = XF_r + YF_a$$

$F_a/F_r \leq e$		$F_a/F_r > e$	
X	Y	X	Y
1	Y_3	0.67	Y_2

Static Equivalent Load

$$P_0 = F_r + Y_0 F_a$$

The values of e , Y_2 , Y_3 , and Y_0 are given in the table below.

Bearing Numbers	Abutment and Fillet Dimensions (mm)				Constant e	Axial Load Factors			Mass (kg) approx.
	d_a	D_b	r_a max.	r_b max.		Y_2	Y_3	Y_0	
130KBE30+L	148	192	2	0.6	0.39	2.6	1.7	1.7	5.4
130KBE030+L	149	193	2	0.6	0.39	2.6	1.7	1.7	6.4
130KBE31+L	151	203	2	0.6	0.37	2.7	1.8	1.8	7.7
130KBE031+L	151	203	2	0.6	0.39	2.6	1.7	1.7	9.6
130KBE2104+L	152	204	2	0.6	0.39	2.6	1.7	1.7	13
130KBE2101+L	154	207	2.5	1	0.35	2.9	1.9	1.9	15
HR130KBE42+L	157	222	3	1	0.44	2.3	1.6	1.5	15.8
HR130KBE2301+L	157	222	3	1	0.44	2.3	1.6	1.5	15.9
130KBE52X+L	158	222	3	1	0.39	2.6	1.7	1.7	22.7
HR130KBE2302+L	158	222	3	1	0.44	2.3	1.6	1.5	24.1
HR130KBE52+L	158	222	3	1	0.44	2.3	1.6	1.5	23.8
HR130KBE2303+L	158	222	3	1	0.44	2.3	1.6	1.5	24.2
130KBE2304+L	158	224	3	1	0.39	2.6	1.7	1.7	24.5
130KBE43+L	169	265	4	1.5	0.36	2.8	1.9	1.8	35
* 797 / 792D+L	153	199	3.5	0.8	0.46	2.2	1.5	1.4	12.4
* 67389 / 67322D+L	152	192	3.5	0.8	0.34	2.9	2.0	1.9	10.6
* 67389 / 67325D+L	152	193	3.5	0.8	0.34	2.9	2.0	1.9	11.2
* 799A / 792D+L	154	199	3.5	0.8	0.46	2.2	1.5	1.4	12.4
133KBE2101+L	160	208	3.5	1.5	0.49	2.1	1.4	1.4	14
* L327249 / L327210D+L	147	172	1.5	0.8	0.35	2.9	1.9	1.9	3.7
* 48385 / 48320D+L	153	185	3.5	0.8	0.32	3.1	2.1	2.1	7.7
* 67390 / 67322D+L	153	192	3.5	0.8	0.34	2.9	2.0	1.9	10
* 67391 / 67322D+L	158	192	8.0	0.8	0.34	2.9	2.0	1.9	9.9
* 67390 / 67325D+L	153	193	3.5	0.8	0.34	2.9	2.0	1.9	10.6

Note * Bearings marked * are inch design.

DOUBLE-ROW TAPERED ROLLER BEARINGS

KBE (TDO) Type, Double Cup, Single Cones

Bore Diameter 133.350 – 139.700 mm

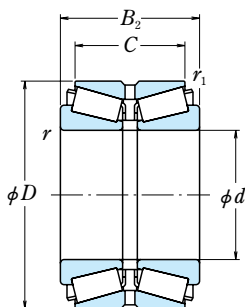

<i>d</i>	Boundary Dimensions (mm/inch)					Basic Load Ratings			
	<i>D</i>	<i>B</i> ₂	<i>C</i>	<i>r</i> min.	<i>r</i> ₁ min.	<i>C</i> _r (kN)	<i>C</i> _{0r} (kgf)	<i>C</i> _r (kN)	<i>C</i> _{0r} (kgf)
133.350 5.2500	215.900 8.5000	106.362 4.1875	80.962 3.1875	3.5	1.5	495	985	50 500	100 000
	234.950 9.2500	142.875 5.6250	114.300 4.5000	9.7	1.5	875	1 580	89 000	161 000
	234.950 9.2500	142.875 5.6250	114.300 4.5000	4.8	1.5	875	1 580	89 000	161 000
135	200	100	85	3	1	495	1 010	50 500	103 000
	210	66	53	2.5	1	305	530	31 000	54 000
	225	85	68	3	1	490	850	50 000	87 000
136.525 5.3750	190.500 7.5000	85.725 3.3750	73.025 2.8750	3.5	0.8	370	880	37 500	90 000
	215.900 8.5000	106.362 4.1875	80.962 3.1875	3.5	1.5	495	985	50 500	100 000
	228.600 9.0000	123.825 4.8750	98.425 3.8750	3.5	1.5	650	1 240	66 500	127 000
139.700 5.5000	254.000 10.0000	152.400 6.0000	114.300 4.5000	7.0	1.5	885	1 660	90 000	169 000
	215.900 8.5000	106.362 4.1875	80.962 3.1875	3.5	1.5	495	985	50 500	100 000
	222.250 8.7500	75.692 2.9800	53.975 2.1250	3.5	2.3	325	535	33 500	54 500
139.700 5.5000	236.538 9.3125	131.762 5.1875	106.362 4.1875	3.5	1.5	775	1 440	79 000	147 000
	236.538 9.3125	131.762 5.1875	106.362 4.1875	3.5	1.5	685	1 360	70 000	139 000
	241.300 9.5000	131.762 5.1875	106.362 4.1875	3.5	1.5	775	1 440	79 000	147 000
	241.300 9.5000	131.762 5.1875	106.362 4.1875	3.5	1.5	685	1 360	70 000	139 000
	254.000 10.0000	149.225 5.8750	111.125 4.3750	7.0	1.5	885	1 660	90 000	169 000
	254.000 10.0000	152.400 6.0000	114.300 4.5000	7.0	1.5	885	1 660	90 000	169 000

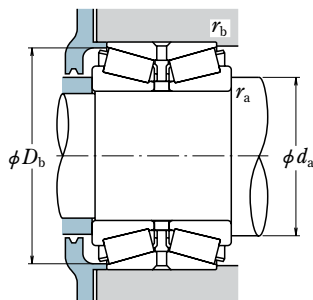

Dynamic Equivalent Load

$$P = XF_r + YF_a$$

$F_a/F_r \leq e$		$F_a/F_r > e$	
X	Y	X	Y
1	Y_3	0.67	Y_2

Static Equivalent Load

$$P_0 = F_r + Y_0 F_a$$

The values of e , Y_2 , Y_3 , and Y_0 are given in the table below.

Bearing Numbers	Abutment and Fillet Dimensions (mm)				Constant e	Axial Load Factors			Mass (kg) approx.
	d_a	D_b	r_a max.	r_b max.		Y_2	Y_3	Y_0	
* 74525 / 74851D+L	160	208	3.5	1.5	0.49	2.1	1.4	1.4	14
* 95525 / 95927D+L	169	226	9.7	1.5	0.37	2.7	1.8	1.8	23.8
* 95528 / 95927D+L	164	226	4.8	1.5	0.37	2.7	1.8	1.8	23.9
135KBE2001+L	153	193	2	1	0.34	2.9	2.0	1.9	9.8
135KBE2101+L	157	203	2	1	0.40	2.5	1.7	1.6	7.5
135KBE2202+L	161	217	2.5	1	0.39	2.6	1.7	1.7	12.4
* 48393 / 48320D+L	155	185	3.5	0.8	0.32	3.1	2.1	2.1	7.3
* 74537 / 74851D+L	162	208	3.5	1.5	0.49	2.1	1.4	1.4	13.4
* 896 / 892D+L	163	219	3.5	1.5	0.42	2.4	1.6	1.6	18.7
* 99537 / 99101D+L	178	245	7.0	1.5	0.41	2.5	1.7	1.6	31.2
* 74550 / 74851D+L	163	208	3.5	1.5	0.49	2.1	1.4	1.4	12.8
* 73551 / 73876D+L	162	211	3.5	2.3	0.44	2.3	1.5	1.5	9.3
* HM231132 / HM231111D+L	168	227	3.5	1.5	0.32	3.2	2.1	2.1	21
* 82550 / 82932D+L	170	228	3.5	1.5	0.44	2.3	1.5	1.5	21.9
* HM231132 / HM231116D+L	168	230	3.5	1.5	0.32	3.2	2.1	2.1	22.6
* 82550 / 82951D+L	170	230	3.5	1.5	0.44	2.3	1.5	1.5	23.2
* 99550 / 99102D+L	179	245	7.0	1.5	0.41	2.5	1.7	1.6	29.7
* 99550 / 99101D+L	179	245	7.0	1.5	0.41	2.5	1.7	1.6	30.4

Note * Bearings marked * are inch design.

DOUBLE-ROW TAPERED ROLLER BEARINGS

KBE (TDO) Type, Double Cup, Single Cones

Bore Diameter 140 – 146.050 mm

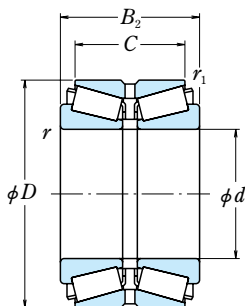

<i>d</i>	Boundary Dimensions (mm/inch)					Basic Load Ratings (kN) (kgf)			
	<i>D</i>	<i>B</i> ₂	<i>C</i>	<i>r</i> min.	<i>r</i> ₁ min.	<i>C</i> _r	<i>C</i> _{0r}	<i>C</i> _r	<i>C</i> _{0r}
140	190	74	60	1	0.6	296	600	30 000	61 000
	200	94.02	73.08	6	1	390	915	39 500	93 500
	210	53	47	2.5	0.6	282	495	28 800	50 500
	210	66	53	2.5	1	305	530	31 000	54 000
	210	69	69	2.5	0.6	380	675	39 000	69 000
	210	106	94	2.5	0.6	555	1 200	57 000	122 000
	210	110	88	1	0.6	555	1 200	57 000	122 000
	225	68	61	3	1	400	630	41 000	64 000
	225	84	68	3	1	490	850	50 000	87 000
	225	85	68	3	1	490	850	50 000	87 000
	230	120	94	3	1	685	1 270	70 000	130 000
	230	124	105	3	1	650	1 240	66 500	127 000
	230	140	110	3	1	820	1 550	84 000	158 000
	240	132	106	4	1.5	685	1 360	70 000	139 000
	250	100	80.5	4	1	630	970	64 500	99 000
	250	102	82.5	4	1	670	1 030	68 000	105 000
	250	153	110	4	1	910	1 700	92 500	173 000
	250	153	125.5	4	1	1 040	1 830	106 000	187 000
	270	120	95	4	3	870	1 440	88 500	147 000
300	145	115.5	5	1.5	1 030	1 480	105 000	151 000	
142.875 5.6250	200.025 7.8750	87.315 3.4376	73.025 2.8750	8.0	0.8	390	915	39 500	93 500
	236.538 9.3125	131.762 5.1875	106.362 4.1875	3.5	1.5	685	1 360	70 000	139 000
	241.300 9.5000	131.762 5.1875	106.362 4.1875	3.5	1.5	685	1 360	70 000	139 000
145	225	70	56	3	1	395	685	40 000	69 500
146.050 5.7500	193.675 7.6250	65.085 2.5624	53.975 2.1250	1.5	0.8	285	695	29 100	70 500
	236.538 9.3125	131.762 5.1875	106.362 4.1875	3.5	1.5	775	1 440	79 000	147 000
	236.538 9.3125	131.762 5.1875	106.362 4.1875	3.5	1.5	685	1 360	70 000	139 000

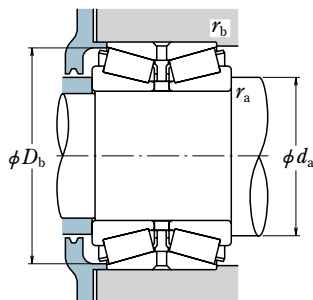

Dynamic Equivalent Load

$$P = X F_r + Y F_a$$

$F_a/F_r \leq e$		$F_a/F_r > e$	
X	Y	X	Y
1	Y_3	0.67	Y_2

Static Equivalent Load

$$P_0 = F_r + Y_0 F_a$$

The values of e , Y_2 , Y_3 , and Y_0 are given in the table below.

Bearing Numbers	Abutment and Fillet Dimensions (mm)				Constant e	Axial Load Factors			Mass (kg) approx.
	d_a	D_b	r_a max.	r_b max.		Y_2	Y_3	Y_0	
140KBE1901+L	153	185	1	0.5	0.38	2.7	1.8	1.7	5.3
140KBE2001+L	163	195	5	1	0.34	3.0	2.0	2.0	8.8
140KBE30+L	159	203	2	0.6	0.39	2.6	1.7	1.7	6.0
140KBE030+L	159	203	2	1	0.40	2.5	1.7	1.6	7.0
140KBE2103+L	157	202	2	0.6	0.20	5.1	3.4	3.3	8.1
140KBE2101+L	160	203	2	0.6	0.33	3.0	2.0	2.0	12.3
140KBE2102+L	159	203	1	0.6	0.33	3.0	2.0	2.0	12.4
140KBE31+L	162	217	2.5	1	0.39	2.6	1.7	1.7	9.3
140KBE031+L	163	217	2.5	1	0.39	2.6	1.7	1.7	11.6
140KBE2201+L	163	217	2.5	1	0.39	2.6	1.7	1.7	11.7
140KBE2301+L	166	222	2.5	1	0.33	3.0	2.0	2.0	17.6
140KBE2305+L	164	221	2.5	1	0.42	2.4	1.6	1.6	18.6
140KBE2302+L	165	222	2.5	1	0.35	2.9	1.9	1.9	20.7
140KBE2401+L	170	230	3	1.5	0.44	2.3	1.5	1.5	22.7
140KBE042+L	169	240	3	1	0.39	2.6	1.7	1.7	18.1
HR140KBE42+L	168	240	3	1	0.44	2.3	1.6	1.5	18.9
140KBE2501+L	174	242	3	1	0.55	1.8	1.2	1.2	29.8
HR140KBE52X+L	170	242	3	1	0.44	2.3	1.6	1.5	29.6
140KBE2701+L	174	253	2.5	2.5	0.33	3.0	2.0	2.0	29.3
140KBE43+L	180	284	4	1.5	0.36	2.8	1.9	1.8	42.6
* 48684 / 48620D+L	167	195	8.0	0.8	0.34	3.0	2.0	2.0	7.9
* 82562 / 82932D+L	171	228	3.5	1.5	0.44	2.3	1.5	1.5	21.2
* 82562 / 82951D+L	171	230	3.5	1.5	0.44	2.3	1.5	1.5	22.4
145KBE2201+L	168	217	2	1	0.35	2.9	1.9	1.9	9.4
* 36690 / 36620D+L	161	188	1.5	0.8	0.37	2.7	1.8	1.8	5.0
* HM231140 / HM231111D+L	171	227	3.5	1.5	0.32	3.2	2.1	2.1	19.6
* 82576 / 82932D+L	173	228	3.5	1.5	0.44	2.3	1.5	1.5	20.4

Note * Bearings marked * are inch design.

DOUBLE-ROW TAPERED ROLLER BEARINGS

KBE (TDO) Type, Double Cup, Single Cones

Bore Diameter 146.050 – 150 mm

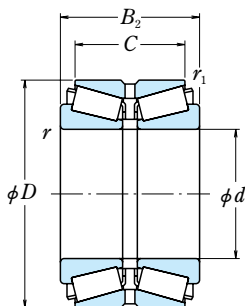

<i>d</i>	Boundary Dimensions (mm/inch)				Basic Load Ratings				
	<i>D</i>	<i>B</i> ₂	<i>C</i>	<i>r</i> min.	<i>r</i> ₁ min.	<i>C</i> _r (kN)	<i>C</i> _{0r} (kgf)	<i>C</i> _r	<i>C</i> _{0r}
146.050 5.7500	241.300 9.5000	131.762 5.1875	106.362 4.1875	3.5	1.5	775	1 440	79 000	147 000
	244.475 9.6250	107.950 4.2500	79.375 3.1250	3.5	1.5	570	1 020	58 000	104 000
	254.000 10.0000	149.225 5.8750	111.125 4.3750	7.0	1.5	885	1 660	90 000	169 000
	268.288 10.5625	160.338 6.3125	125.412 4.9375	6.4	1.5	1 040	1 960	106 000	200 000
	304.800 12.0000	135.733 5.3438	97.633 3.8438	3.3	1.5	1 090	1 560	111 000	159 000
	307.975 12.1250	200.025 7.8750	155.575 6.1250	9.7	2.3	1 510	2 380	154 000	243 000
	149.225 5.8750	236.538 9.3125	131.762 5.1875	106.362 4.1875	6.4	1.5	775	1 440	79 000
236.538 9.3125		131.762 5.1875	106.362 4.1875	3.5	1.5	775	1 440	79 000	147 000
236.538 9.3125		131.762 5.1875	106.362 4.1875	3.5	1.5	685	1 360	70 000	139 000
241.300 9.5000		131.762 5.1875	106.362 4.1875	3.5	1.5	775	1 440	79 000	147 000
241.300 9.5000		131.762 5.1875	106.362 4.1875	3.5	1.5	685	1 360	70 000	139 000
254.000 10.0000		149.225 5.8750	111.125 4.3750	7.0	1.5	885	1 660	90 000	169 000
150		225	56	50	3	1	300	545	30 500
	225	70	56	3	1	395	685	40 000	69 500
	245	108	80	4	1	570	1 020	58 000	104 000
	250	80	71	3	1	510	810	52 000	82 500
	250	100	80	3	1	630	1 090	64 500	111 000
	250	115	95	3	1	745	1 320	76 000	134 000
	250	138	112	4	0.6	865	1 630	88 500	167 000
	250	140	115	4	0.6	865	1 630	88 500	167 000
	250	142	112	4	1.5	885	1 660	90 000	169 000

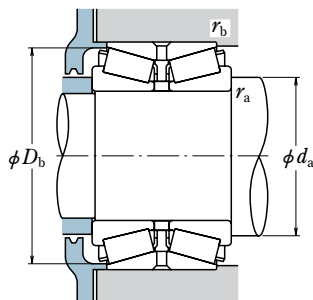

Dynamic Equivalent Load

$$P = XF_r + YF_a$$

$F_a/F_r \leq e$		$F_a/F_r > e$	
X	Y	X	Y
1	Y_3	0.67	Y_2

Static Equivalent Load

$$P_0 = F_r + Y_0 F_a$$

The values of e , Y_2 , Y_3 , and Y_0 are given in the table below.

Bearing Numbers	Abutment and Fillet Dimensions (mm)				Constant e	Axial Load Factors			Mass (kg) approx.
	d_a	D_b	r_a max.	r_b max.		Y_2	Y_3	Y_0	
* HM231140 / HM231116D+L	171	230	3.5	1.5	0.32	3.2	2.1	2.1	21.2
* 81575 / 81963D+L	175	235	3.5	1.5	0.35	2.9	1.9	1.9	17.9
* 99575 / 99102D+L	182	245	7.0	1.5	0.41	2.5	1.7	1.6	28
* EE107057 / 107105D+L	184	256	6.4	1.5	0.39	2.6	1.7	1.7	36.5
* EE750576 / 751204D+L	180	285	3.3	1.5	0.33	3.0	2.0	2.0	42.1
* HH234040 / HH234011D+L	194	294	9.7	2.3	0.33	3.1	2.1	2.0	61.6
* HM231148 / HM231111D+L	176	227	6.4	1.5	0.32	3.2	2.1	2.1	18.8
* HM231149 / HM231111D+L	173	227	3.5	1.5	0.32	3.2	2.1	2.1	18.8
* 82587 / 82932D+L	175	228	3.5	1.5	0.44	2.3	1.5	1.5	19.7
* HM231149 / HM231116D+L	173	230	3.5	1.5	0.32	3.2	2.1	2.1	20.4
* 82587 / 82951D+L	175	230	3.5	1.5	0.44	2.3	1.5	1.5	21
* 99587 / 99102D+L	184	245	7.0	1.5	0.41	2.5	1.7	1.6	27.4
150KBE30+L	170	216	2.5	1	0.35	2.9	1.9	1.9	7.4
150KBE030+L	170	217	2.5	1	0.35	2.9	1.9	1.9	8.7
150KBE2401+L	177	235	3	1	0.35	2.9	1.9	1.9	17.1
150KBE31+L	176	242	2.5	1	0.40	2.5	1.7	1.6	14.2
150KBE031+L	177	241	2.5	1	0.39	2.6	1.7	1.7	17.8
150KBE2502+L	177	241	2.5	1	0.37	2.7	1.8	1.8	20.9
150KBE2503+L	181	244	3	0.6	0.41	2.4	1.6	1.6	25.1
150KBE2504+L	181	244	3	0.6	0.41	2.4	1.6	1.6	25.4
150KBE2505+L	181	243	3	1.5	0.41	2.5	1.7	1.6	25

Note * Bearings marked * are inch design.

DOUBLE-ROW TAPERED ROLLER BEARINGS

KBE (TDO) Type, Double Cup, Single Cones

Bore Diameter 150 – 159 mm

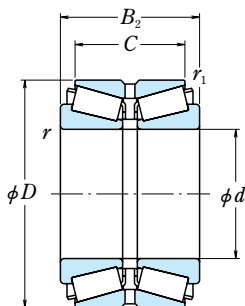

<i>d</i>	Boundary Dimensions (mm/inch)					Basic Load Ratings			
	<i>D</i>	<i>B</i> ₂	<i>C</i>	<i>r</i> min.	<i>r</i> ₁ min.	(kN)		(kgf)	
						<i>C</i> _r	<i>C</i> _{0r}	<i>C</i> _r	<i>C</i> _{0r}
150	260	150	115	4	1	815	1 520	83 000	155 000
	270	108	76	4	1	740	1 140	75 500	116 000
	270	109	87	4	1	830	1 330	84 500	135 000
	270	162	128	4	1	1 210	2 150	123 000	219 000
	270	164	130	4	1	1 210	2 150	123 000	219 000
	320	154	120	5	1.5	1 420	2 130	145 000	217 000
150.812 5.9375	244.475	107.950	79.375	3.5	1.5	570	1 020	58 000	104 000
	9.6250	4.2500	3.1250						
152.400 6.0000	222.250	100.010	76.200	8.0	0.8	490	1 060	50 000	108 000
	8.7500	3.9374	3.0000						
	222.250	100.010	76.200	3.5	0.8	490	1 060	50 000	108 000
	8.7500	3.9374	3.0000						
	222.250	106.360	82.550	3.5	0.8	490	1 060	50 000	108 000
	8.7500	4.1874	3.2500						
	244.475	107.950	79.375	3.5	1.5	570	1 020	58 000	104 000
	9.6250	4.2500	3.1250						
	254.000	149.225	111.125	7.0	1.5	885	1 660	90 000	169 000
	10.0000	5.8750	4.3750						
254.000	152.400	114.300	7.0	1.5	885	1 660	90 000	169 000	
10.0000	6.0000	4.5000							
268.288	160.338	125.412	6.4	1.5	1 040	1 960	106 000	200 000	
10.5625	6.3125	4.9375							
307.975	200.025	146.050	9.7	2.3	1 280	2 150	130 000	219 000	
12.1250	7.8750	5.7500							
307.975	200.025	155.575	9.7	2.3	1 510	2 380	154 000	243 000	
12.1250	7.8750	6.1250							
158.750 6.2500	225.425	85.725	69.850	3.5	0.8	410	1 080	42 000	110 000
	8.8750	3.3750	2.7500						
	288.925	142.875	111.125	7.0	1.5	1 050	1 870	107 000	191 000
	11.3750	5.6250	4.3750						
159	230	80	56	2.5	0.6	400	755	40 500	77 000
	290	155	117	4	1	1 060	1 900	108 000	194 000

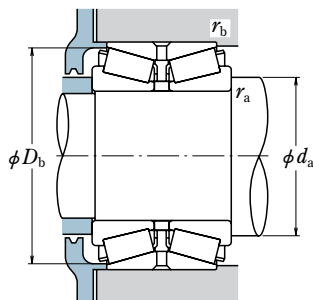

Dynamic Equivalent Load

$$P = XF_r + YF_a$$

$F_a/F_r \leq e$		$F_a/F_r > e$	
X	Y	X	Y
1	Y_3	0.67	Y_2

Static Equivalent Load

$$P_0 = F_r + Y_0 F_a$$

The values of e , Y_2 , Y_3 , and Y_0 are given in the table below.

Bearing Numbers	Abutment and Fillet Dimensions (mm)				Constant e	Axial Load Factors			Mass (kg) approx.
	d_a	D_b	r_a max.	r_b max.		Y_2	Y_3	Y_0	
150KBE2601+L	181	248	3	1	0.43	2.3	1.6	1.5	30
150KBE2702+L	180	258	3	1	0.43	2.3	1.6	1.5	22.7
HR150KBE42+L	180	258	3	1	0.44	2.3	1.6	1.5	24.3
HR150KBE2701+L	182	260	3	1	0.44	2.3	1.6	1.5	39.7
HR150KBE52X+L	182	260	3	1	0.44	2.3	1.6	1.5	37.3
HR150KBE43+L	191	304	4	1.5	0.35	2.9	2.0	1.9	53.4
* 81593 / 81963D+L	177	235	3.5	1.5	0.35	2.9	1.9	1.9	16.9
* M231648 / M231610D+L	179	215	8.0	0.8	0.33	3.0	2.0	2.0	11.9
* M231649 / M231610D+L	175	215	3.5	0.8	0.33	3.0	2.0	2.0	12
* M231649 / M231611D+L	175	215	3.5	0.8	0.33	3.0	2.0	2.0	12.5
* 81600 / 81963D+L	178	235	3.5	1.5	0.35	2.9	1.9	1.9	16.6
* 99600 / 99102D+L	185	245	7.0	1.5	0.41	2.5	1.7	1.6	26.5
* 99600 / 99101D+L	185	245	7.0	1.5	0.41	2.5	1.7	1.6	27.1
* EE107060 / 107105D+L	187	256	6.4	1.5	0.39	2.6	1.7	1.7	34.6
* EE450601 / 451215D+L	199	289	9.7	2.3	0.33	3.1	2.1	2.0	60.1
* HH234048 / HH234011D+L	197	294	9.7	2.3	0.33	3.1	2.1	2.0	59.3
* 46780 / 46720D+L	183	219	3.5	0.8	0.38	2.6	1.8	1.7	11.1
* 158KBE2851+L	201	278	7.0	1.5	0.32	3.2	2.1	2.1	37.3
159KBE2301+L	180	224	2	0.6	0.52	1.9	1.3	1.3	9.4
159KBE2901+L	198	280	3	1	0.55	1.8	1.2	1.2	40.3

Note * Bearings marked * are inch design.

DOUBLE-ROW TAPERED ROLLER BEARINGS

KBE (TDO) Type, Double Cup, Single Cones

Bore Diameter 159.951 – 165.100 mm

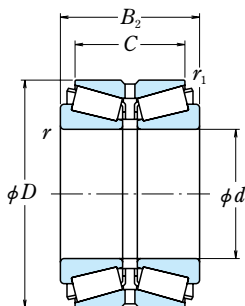

<i>d</i>	Boundary Dimensions (mm/inch)					Basic Load Ratings			
	<i>D</i>	<i>B</i> ₂	<i>C</i>	<i>r</i> min.	<i>r</i> ₁ min.	(kN)		(kgf)	
						<i>C</i> _r	<i>C</i> _{0r}	<i>C</i> _r	<i>C</i> _{0r}
159.951 6.2973	244.475 9.6250	107.950 4.2500	79.375 3.1250	3.5	1.5	570	1 020	58 000	104 000
160	220	90	71	2.5	0.6	430	910	43 500	93 000
	240	60	53	3	1	355	580	36 000	59 500
	240	75	60	3	1	395	710	40 500	72 500
	240	110	90	3	1	650	1 290	66 500	132 000
	262	140	120	3	1	865	1 780	88 500	181 000
	270	86	76	3	1	540	885	55 000	90 000
	270	108	86	3	1	775	1 380	79 000	140 000
	270	140	110	3	1	990	1 880	101 000	192 000
	270	140	120	3	1	990	1 880	101 000	192 000
	270	149	120	3	1	990	1 880	101 000	192 000
	280	140	120	3	1	990	1 880	101 000	192 000
	280	150	125	4	1	1 100	2 020	112 000	206 000
	290	115	91	4	1	800	1 220	82 000	124 000
	290	178	144	4	1	1 360	2 440	139 000	249 000
340	160	126	5	1.5	1 310	1 920	134 000	196 000	
160.325 6.3120	288.925 11.3750	142.875 5.6250	111.125 4.3750	7.0	1.5	1 050	1 870	107 000	191 000
165	225	95	70	3	0.6	410	1 080	42 000	110 000
	290	150	125	4	1	1 140	2 130	116 000	217 000
165.100 6.5000	215.900 8.5000	58.740 2.3126	47.625 1.8750	1.5	0.8	263	590	26 800	60 000
	225.425 8.8750	85.725 3.3750	69.850 2.7500	3.5	0.8	410	1 080	42 000	110 000
	247.650 9.7500	103.188 4.0625	84.138 3.3125	3.5	0.8	595	1 410	60 500	143 000
	254.000 10.0000	101.600 4.0000	76.200 3.0000	4.8	1.5	635	1 190	64 500	122 000
	288.925 11.3750	142.875 5.6250	111.125 4.3750	7.0	1.5	1 050	1 870	107 000	191 000

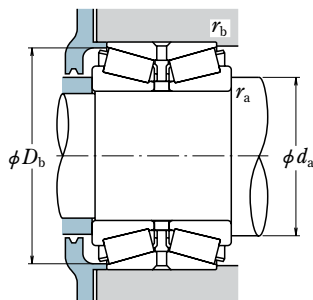

Dynamic Equivalent Load

$$P = XF_r + YF_a$$

$F_a/F_r \leq e$		$F_a/F_r > e$	
X	Y	X	Y
1	Y_3	0.67	Y_2

Static Equivalent Load

$$P_0 = F_r + Y_0 F_a$$

The values of e , Y_2 , Y_3 , and Y_0 are given in the table below.

Bearing Numbers	Abutment and Fillet Dimensions (mm)				Constant e	Axial Load Factors			Mass (kg) approx.
	d_a	D_b	r_a max.	r_b max.		Y_2	Y_3	Y_0	
* 81629 / 81963D+L	182	235	3.5	1.5	0.35	2.9	1.9	1.9	15.1
160KBE2201+L	178	215	2	0.6	0.35	2.9	1.9	1.9	9.1
160KBE30+L	181	232	2.5	1	0.37	2.7	1.8	1.8	8.5
160KBE030+L	182	232	2.5	1	0.40	2.5	1.7	1.6	10.5
160KBE2401+L	183	233	2.5	1	0.38	2.6	1.8	1.7	16.2
160KBE2602+L	191	255	2.5	1	0.44	2.3	1.5	1.5	28.3
160KBE31+L	189	259	2.5	1	0.40	2.5	1.7	1.6	18.6
160KBE031+L	190	260	2.5	1	0.39	2.6	1.7	1.7	23.1
160KBE2705+L	191	261	2.5	1	0.39	2.6	1.7	1.7	30.1
160KBE2701+L	191	262	2.5	1	0.39	2.6	1.7	1.7	30.6
160KBE2703+L	191	261	2.5	1	0.39	2.6	1.7	1.7	31.7
160KBE2802+L	191	267	2.5	1	0.39	2.6	1.7	1.7	34.7
160KBE2801+L	194	270	3	1	0.32	3.2	2.1	2.1	35.9
160KBE42+L	195	279	3	1	0.43	2.3	1.6	1.5	28.2
HR160KBE52X+L	195	280	3	1	0.44	2.3	1.6	1.5	47.3
160KBE43+L	205	323	4	1.5	0.36	2.8	1.9	1.8	60.4
* HM237532 / HM237510D+L	202	278	7.0	1.5	0.32	3.2	2.1	2.1	36.8
165KBE2201+L	185	219	2.5	0.6	0.38	2.6	1.8	1.7	10.6
165KBE2901+L	199	278	3	1	0.33	3.1	2.1	2.0	39.5
* L433749 / L433710D+L	180	210	1.5	0.8	0.36	2.8	1.9	1.8	5.3
* 46790 / 46720D+L	186	219	3.5	0.8	0.38	2.6	1.8	1.7	9.9
* 67780 / 67720D+L	194	241	3.5	0.8	0.44	2.3	1.5	1.5	17.2
* M235145 / M235113D+L	191	244	4.8	1.5	0.32	3.2	2.1	2.1	16.4
* HM237535 / HM237510D+L	204	278	7.0	1.5	0.32	3.2	2.1	2.1	35.4

Note * Bearings marked * are inch design.

DOUBLE-ROW TAPERED ROLLER BEARINGS

KBE (TDO) Type, Double Cup, Single Cones

Bore Diameter 165.100 – 171.450 mm

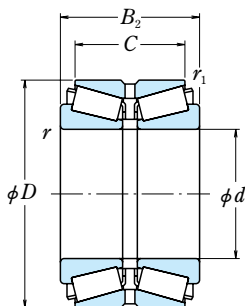

<i>d</i>	Boundary Dimensions (mm/inch)					Basic Load Ratings			
	<i>D</i>	<i>B</i> ₂	<i>C</i>	<i>r</i> min.	<i>r</i> ₁ min.	(kN)		(kgf)	
						<i>C</i> _r	<i>C</i> _{0r}	<i>C</i> _r	<i>C</i> _{0r}
165.100 6.5000	288.925 11.3750	142.875 5.6250	111.125 4.3750	7.0	1.5	930	1 880	95 000	192 000
	288.925 11.3750	142.875 5.6250	111.125 4.3750	7.0	1.5	930	1 880	95 000	192 000
	288.925 11.3750	146.050 5.7500	114.300 4.5000	7.0	1.5	1 050	1 870	107 000	191 000
	298.450 11.7500	142.875 5.6250	111.125 4.3750	7.0	1.5	930	1 880	95 000	192 000
	347.662 13.6875	146.050 5.7500	107.950 4.2500	9.7	1.5	1 310	2 010	134 000	205 000
	368.300 14.5000	193.675 7.6250	136.525 5.3750	9.7	1.5	1 500	2 690	153 000	274 000
168.275 6.6250	247.650 9.7500	103.188 4.0625	84.138 3.3125	3.5	0.8	595	1 410	60 500	143 000
170	250	85	65	3	1	435	845	44 500	86 000
	260	67	60	3	1	400	700	40 500	71 000
	260	84	67	3	1	575	1 030	58 500	105 000
	280	88	78	3	1	630	1 040	64 000	106 000
	280	110	88	3	1	820	1 450	83 500	148 000
	280	110	90	3	1	820	1 450	83 500	148 000
	280	123	100	3	1	810	1 660	82 500	170 000
	280	150	130	3	1	1 110	2 160	113 000	220 000
	310	122	94	5	1.5	900	1 380	92 000	141 000
	310	125	97	5	1.5	900	1 380	92 000	141 000
	310	192	152	5	1.5	1 590	2 910	162 000	297 000
	320	180	140	5	1.5	1 410	2 510	144 000	256 000
170.000 6.6929	254.000 10.0000	101.600 4.0000	76.200 3.0000	4.8	1.5	635	1 190	64 500	122 000
	171.450 6.7500	288.925 11.3750	142.875 5.6250	111.125 4.3750	7.0	1.5	930	1 880	95 000
298.450 11.7500		142.875 5.6250	111.125 4.3750	7.0	1.5	930	1 880	95 000	192 000

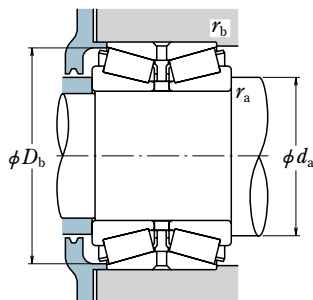

Dynamic Equivalent Load

$$P = XF_r + YF_a$$

$F_a/F_r \leq e$		$F_a/F_r > e$	
X	Y	X	Y
1	Y_3	0.67	Y_2

Static Equivalent Load

$$P_0 = F_r + Y_0 F_a$$

The values of e , Y_2 , Y_3 , and Y_0 are given in the table below.

Bearing Numbers	Abutment and Fillet Dimensions (mm)				Constant e	Axial Load Factors			Mass (kg) approx.
	d_a	D_b	r_a max.	r_b max.		Y_2	Y_3	Y_0	
* 94649 / 94114D+L	206	277	7.0	1.5	0.47	2.1	1.4	1.4	37.4
* 94650 / 94114D+L	206	277	7.0	1.5	0.47	2.1	1.4	1.4	37.4
* HM237535 / HM237511D+L	204	278	7.0	1.5	0.32	3.2	2.1	2.1	36
* 94649 / 94118D+L	206	282	7.0	1.5	0.47	2.1	1.4	1.4	41.3
* EE618065 / 618136D+L	214	326	9.7	1.5	0.33	3.0	2.0	2.0	58.7
* EE420651 / 421451D+L	234	353	9.7	1.5	0.42	2.4	1.6	1.6	93
* 67782 / 67720D+L	195	241	3.5	0.8	0.44	2.3	1.5	1.5	16.5
170KBE2501+L	193	242	2	0.8	0.44	2.3	1.5	1.5	12.3
170KBE30+L	194	251	2.5	1	0.40	2.5	1.7	1.6	11.8
170KBE030+L	194	251	2.5	1	0.39	2.6	1.7	1.7	14.4
170KBE31+L	198	270	2.5	1	0.39	2.6	1.7	1.7	19.7
170KBE031+L	200	271	2.5	1	0.39	2.6	1.7	1.7	24.2
170KBE2801+L	200	271	2.5	1	0.39	2.6	1.7	1.7	24.3
170KBE2803+L	195	262	2	0.8	0.38	2.6	1.8	1.7	28.5
170KBE2802+L	200	271	2.5	1	0.39	2.6	1.7	1.7	34.6
170KBE042+L	207	297	4	1.5	0.43	2.3	1.6	1.5	34.1
170KBE42+L	207	297	4	1.5	0.43	2.3	1.6	1.5	34.9
HR170KBE52X+L	209	300	4	1.5	0.44	2.3	1.6	1.5	57.3
170KBE3201+L	215	309	4	1.5	0.43	2.3	1.6	1.5	59.8
* M235149 / M235113D+L	194	244	4.8	1.5	0.32	3.2	2.1	2.1	15.4
* 94675 / 94114D+L	209	277	7.0	1.5	0.47	2.1	1.4	1.4	35.5
* 94675 / 94118D+L	209	282	7.0	1.5	0.47	2.1	1.4	1.4	39.5

Note * Bearings marked * are inch design.

DOUBLE-ROW TAPERED ROLLER BEARINGS

KBE (TDO) Type, Double Cup, Single Cones

Bore Diameter 174.625 – 177.800 mm

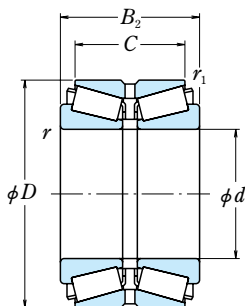

d	Boundary Dimensions (mm/inch)				Basic Load Ratings				
	D	B_2	C	r min.	r_1 min.	C_r (kN)	C_{0r} (kgf)	C_r (kgf)	C_{0r} (kgf)
174.625 6.8750	247.650 9.7500	103.188 4.0625	84.138 3.3125	3.5	0.8	595	1 410	60 500	143 000
	288.925 11.3750	142.875 5.6250	111.125 4.3750	7.0	1.5	1 050	1 870	107 000	191 000
	288.925 11.3750	146.050 5.7500	114.300 4.5000	7.0	1.5	1 050	1 870	107 000	191 000
175	320	180	140	5	1.5	1 410	2 510	144 000	256 000
177.800 7.0000	227.012 8.9375	66.672 2.6249	52.388 2.0625	1.5	0.8	299	785	30 500	80 000
	247.650 9.7500	103.188 4.0625	84.138 3.3125	3.5	0.8	595	1 410	60 500	143 000
	247.650 9.7500	103.188 4.0625	84.138 3.3125	10.4	0.8	595	1 410	60 500	143 000
	269.875 10.6250	119.062 4.6875	93.662 3.6875	3.5	1.5	795	1 750	81 000	179 000
	285.750 11.2500	136.525 5.3750	92.075 3.6250	6.4	1.5	775	1 450	79 000	148 000
	288.925 11.3750	142.875 5.6250	111.125 4.3750	7.0	1.5	1 050	1 870	107 000	191 000
	288.925 11.3750	142.875 5.6250	111.125 4.3750	7.0	1.5	930	1 880	95 000	192 000
	288.925 11.3750	146.050 5.7500	114.300 4.5000	7.0	1.5	1 050	1 870	107 000	191 000
	288.925 11.3750	146.050 5.7500	114.300 4.5000	7.0	1.5	1 050	1 870	107 000	191 000
	298.450 11.7500	142.875 5.6250	111.125 4.3750	7.0	1.5	930	1 880	95 000	192 000
	320.675 12.6250	185.738 7.3125	138.112 5.4375	3.5	1.5	1 350	2 600	138 000	265 000

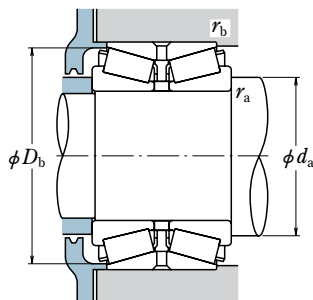

Dynamic Equivalent Load

$$P = XF_r + YF_a$$

$F_a/F_r \leq e$		$F_a/F_r > e$	
X	Y	X	Y
1	Y_3	0.67	Y_2

Static Equivalent Load

$$P_0 = F_r + Y_0 F_a$$

The values of e , Y_2 , Y_3 , and Y_0 are given in the table below.

Bearing Numbers	Abutment and Fillet Dimensions (mm)				Constant e	Axial Load Factors			Mass (kg) approx.
	d_a	D_b	r_a max.	r_b max.		Y_2	Y_3	Y_0	
* 67787 / 67720D+L	199	241	3.5	0.8	0.44	2.3	1.5	1.5	15.1
* HM237542 / HM237510D+L	209	278	7.0	1.5	0.32	3.2	2.1	2.1	32.7
* HM237542 / HM237511D+L	209	278	7.0	1.5	0.32	3.2	2.1	2.1	33.1
175KBE3201+L	216	309	4	1.5	0.43	2.3	1.6	1.5	57.7
* 36990 / 36920D+L	193	222	1.5	0.8	0.44	2.3	1.5	1.5	6.4
* 67790 / 67720D+L	200	241	3.5	0.8	0.44	2.3	1.5	1.5	14.4
* 67791 / 67720D+L	207	241	10.4	0.8	0.44	2.3	1.5	1.5	14.2
* M238840 / M238810D+L	208	262	3.5	1.5	0.35	2.9	1.9	1.9	23.2
* EE91702 / 91113XD+L	210	274	6.4	1.5	0.43	2.3	1.6	1.5	28.7
* HM237545 / HM237510D+L	210	278	7.0	1.5	0.32	3.2	2.1	2.1	31.7
* 94700 / 94114D+L	213	277	7.0	1.5	0.47	2.1	1.4	1.4	33.6
* HM237545 / HM237511D+L	210	278	7.0	1.5	0.32	3.2	2.1	2.1	32.2
* HM237545 / HM237511XD+L	210	278	7.0	1.5	0.32	3.2	2.1	2.1	32.7
* 94700 / 94118D+L	213	282	7.0	1.5	0.47	2.1	1.4	1.4	37.5
* EE222070 / 222127D+L	218	308	3.5	1.5	0.40	2.5	1.7	1.7	59.6

Note * Bearings marked * are inch design.

DOUBLE-ROW TAPERED ROLLER BEARINGS

KBE (TDO) Type, Double Cup, Single Cones

Bore Diameter 177.800 – 187.325 mm

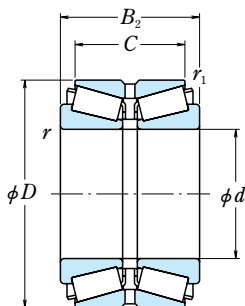

<i>d</i>	Boundary Dimensions (mm/inch)					Basic Load Ratings			
	<i>D</i>	<i>B</i> ₂	<i>C</i>	<i>r</i> min.	<i>r</i> ₁ min.	(kN)		(kgf)	
						<i>C</i> _r	<i>C</i> _{0r}	<i>C</i> _r	<i>C</i> _{0r}
177.800 7.0000	320.675 12.6250	185.738 7.3125	138.112 5.4375	3.5	1.5	1 470	2 530	150 000	258 000
	320.675 12.6250	185.738 7.3125	138.112 5.4375	3.5	1.5	1 270	2 420	130 000	246 000
	368.300 14.5000	193.675 7.6250	136.525 5.3750	12.7	1.5	1 500	2 690	153 000	274 000
179.972 7.0855	317.500 12.5000	146.050 5.7500	111.125 4.3750	3.5	1.5	990	2 120	101 000	216 000
	319.976 12.5975	146.050 5.7500	111.125 4.3750	3.5	1.5	990	2 120	101 000	216 000
180	280	74	66	3	1	455	810	46 500	82 500
	280	93	74	3	1	655	1 220	67 000	124 000
	290	150	120	3	1	1 140	2 260	116 000	230 000
	300	96	85	4	1.5	725	1 210	73 500	123 000
	300	120	96	4	1.5	940	1 690	96 000	173 000
	320	127	99	5	1.5	895	1 390	91 500	141 000
	320	192	152	5	1.5	1 640	3 050	168 000	315 000
184.150 7.2500	236.538 9.3125	55.560 2.1874	41.275 1.6250	1.5	0.8	265	580	27 000	59 500
	266.700 10.5000	103.188 4.0625	84.138 3.3125	3.5	0.8	590	1 440	60 000	146 000
	288.925 11.3750	142.875 5.6250	111.125 4.3750	7.0	1.5	1 050	1 870	107 000	191 000
	295.275 11.6250	142.875 5.6250	111.125 4.3750	7.0	1.5	1 050	1 870	107 000	191 000
187.325 7.3750	266.700 10.5000	103.188 4.0625	84.138 3.3125	3.5	0.8	590	1 440	60 000	146 000
	269.875 10.6250	119.063 4.6875	93.662 3.6875	3.5	1.5	795	1 750	81 000	179 000
	320.675 12.6250	185.738 7.3125	138.112 5.4375	5.5	1.5	1 470	2 530	150 000	258 000

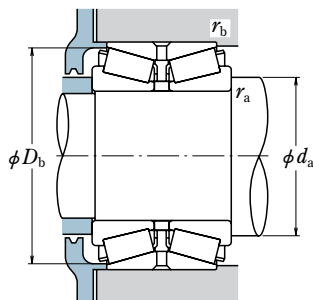

Dynamic Equivalent Load

$$P = XF_r + YF_a$$

$F_a/F_r \leq e$		$F_a/F_r > e$	
X	Y	X	Y
1	Y_3	0.67	Y_2

Static Equivalent Load

$$P_0 = F_r + Y_0 F_a$$

The values of e , Y_2 , Y_3 , and Y_0 are given in the table below.

Bearing Numbers	Abutment and Fillet Dimensions (mm)				Constant e	Axial Load Factors			Mass (kg) approx.
	d_a	D_b	r_a max.	r_b max.		Y_2	Y_3	Y_0	
* H239640 / H239612D+L	215	309	3.5	1.5	0.32	3.2	2.1	2.1	55.6
* 177KBE3251+L	218	309	3.5	1.5	0.49	2.1	1.4	1.4	58.9
* EE420701 / 421451D+L	243	353	12.7	1.5	0.42	2.4	1.6	1.6	87.6
* 93708 / 93127D+L	224	306	3.5	1.5	0.52	1.9	1.3	1.3	46.9
* 93708 / 93128XD+L	224	307	3.5	1.5	0.52	1.9	1.3	1.3	49.1
180KBE30+L	207	269	2.5	1	0.40	2.5	1.7	1.6	15.4
180KBE030+L	207	269	2.5	1	0.35	2.9	1.9	1.9	19.5
180KBE2902+L	210	280	2.5	1	0.40	2.5	1.7	1.6	35.7
180KBE31+L	211	288	3	1.5	0.39	2.6	1.7	1.7	24.8
180KBE031+L	214	290	3	1.5	0.39	2.6	1.7	1.7	31.1
180KBE42+L	215	306	4	1.5	0.44	2.3	1.5	1.5	36.5
HR180KBE52X+L	219	310	4	1.5	0.45	2.2	1.5	1.5	59.2
180KBE3401+L	220	319	4	1.5	0.43	2.3	1.6	1.5	68.1
* LL537649 / LL537610D+L	199	230	1.5	0.8	0.37	2.7	1.8	1.8	5.5
* 67883 / 67820D+L	212	260	3.5	0.8	0.48	2.1	1.4	1.4	18.4
* 184KBE2851+L	214	278	7.0	1.5	0.32	3.2	2.1	2.1	29.6
* 184KBE2951+L	214	282	7.0	1.5	0.32	3.2	2.1	2.1	32.2
* 67884 / 67820D+L	214	260	3.5	0.8	0.48	2.1	1.4	1.4	17.7
* M238849 / M238810D+L	212	262	3.5	1.5	0.35	2.9	1.9	1.9	20.7
* H239649 / H239612D+L	222	309	5.5	1.5	0.32	3.2	2.1	2.1	51.6

Note * Bearings marked * are inch design.

DOUBLE-ROW TAPERED ROLLER BEARINGS

KBE (TDO) Type, Double Cup, Single Cones

Bore Diameter 190 – 200 mm

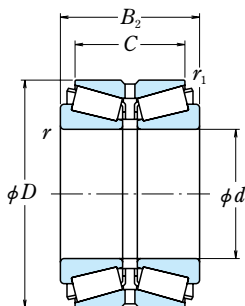

<i>d</i>	Boundary Dimensions (mm/inch)					Basic Load Ratings			
	<i>D</i>	<i>B</i> ₂	<i>C</i>	<i>r</i> min.	<i>r</i> ₁ min.	(kN)		(kgf)	
						<i>C</i> _r	<i>C</i> _{0r}	<i>C</i> _r	<i>C</i> _{0r}
190	260	94	76	2.5	0.6	580	1 290	59 000	131 000
	290	75	67	3	1	490	845	50 000	86 500
	290	94	75	3	1	670	1 230	68 000	126 000
	320	104	92	4	1.5	800	1 380	81 500	141 000
	320	130	104	4	1.5	1 070	1 960	109 000	200 000
	320	171	134	4	1	1 330	2 530	136 000	258 000
340	133	105	105	5	1.5	990	1 580	101 000	161 000
	340	204	160	5	1.5	1 910	3 550	194 000	360 000
190.500 7.5000	266.700 10.5000	103.188 4.0625	84.138 3.3125	3.5	0.8	590	1 440	60 000	146 000
	282.575 11.1250	107.950 4.2500	79.375 3.1250	3.5	1.5	615	1 200	62 500	123 000
	317.500 12.5000	146.050 5.7500	111.125 4.3750	4.3	1.5	990	2 120	101 000	216 000
196.850 7.7500	254.000 10.0000	61.910 2.4374	47.625 1.8750	1.5	0.8	305	715	31 000	72 500
	317.500 12.5000	146.050 5.7500	111.125 4.3750	4.3	1.5	990	2 120	101 000	216 000
200	290	121.45	88	6	1	765	1 720	78 000	175 000
	310	82	73	3	1	585	1 070	59 500	109 000
	310	103	82	3	1	775	1 400	79 000	143 000
	310	152	123	3	1	1 300	2 740	133 000	279 000
	320	146	110	5	1.5	990	2 120	101 000	216 000
	330	180	140	5	1.5	1 390	2 730	142 000	279 000
	340	112	100	4	1.5	940	1 670	96 000	170 000
	340	140	112	4	1.5	1 260	2 250	128 000	229 000
	340	183	150	4	1	1 580	3 050	161 000	310 000
	350	140	112	4	1.5	1 260	2 250	128 000	229 000
	356	152	111	6	1.5	1 190	2 470	122 000	252 000
	360	142	110	5	1.5	1 100	1 780	112 000	181 000
	360	218	174	5	1.5	2 070	3 850	211 000	390 000

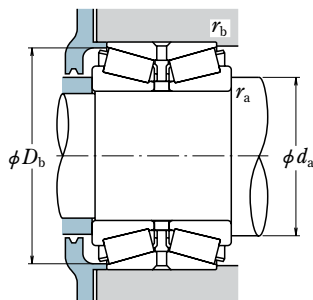

Dynamic Equivalent Load

$$P = X F_r + Y F_a$$

$F_a/F_r \leq e$		$F_a/F_r > e$	
X	Y	X	Y
1	Y_3	0.67	Y_2

Static Equivalent Load

$$P_0 = F_r + Y_0 F_a$$

The values of e , Y_2 , Y_3 , and Y_0 are given in the table below.

Bearing Numbers	Abutment and Fillet Dimensions (mm)				Constant e	Axial Load Factors			Mass (kg) approx.
	d_a	D_b	r_a max.	r_b max.		Y_2	Y_3	Y_0	
190KBE2601+L	210	254	2	0.6	0.39	2.6	1.7	1.7	13.5
190KBE30+L	217	281	2.5	1	0.39	2.6	1.7	1.7	16.2
190KBE030+L	217	281	2.5	1	0.40	2.5	1.7	1.6	20.1
190KBE31+L	224	307	3	1.5	0.40	2.5	1.7	1.6	30.9
190KBE031+L	225	307	3	1.5	0.39	2.6	1.7	1.7	39
190KBE3201+L	225	308	3	1	0.38	2.7	1.8	1.8	50.1
190KBE42+L	230	326	4	1.5	0.40	2.5	1.7	1.6	43.9
HR190KBE52X+L	230	329	4	1.5	0.44	2.3	1.6	1.5	70.8
* 67885 / 67820D+L	215	260	3.5	0.8	0.48	2.1	1.4	1.4	16.9
* 87750 / 87112D+L	217	273	3.5	1.5	0.42	2.4	1.6	1.6	20.2
* 93750 / 93127D+L	231	306	4.3	1.5	0.52	1.9	1.3	1.3	43.7
* L540049 / L540010D+L	213	247	1.5	0.8	0.40	2.5	1.7	1.7	7.4
* 93775 / 93127D+L	234	306	4.3	1.5	0.52	1.9	1.3	1.3	41.5
200KBE2901+L	228	279	4	0.8	0.40	2.5	1.7	1.6	23.7
200KBE30+L	229	299	2.5	1	0.40	2.5	1.7	1.6	21.2
200KBE030+L	228	300	2.5	1	0.43	2.3	1.6	1.5	25.1
HR200KBE3101+L	231	302	2.5	1	0.43	2.3	1.6	1.5	40.1
200KBE3201+L	236	307	4	1.5	0.52	1.9	1.3	1.3	41.6
200KBE3301+L	237	319	4	1.5	0.42	2.4	1.6	1.6	54.4
200KBE31+L	237	326	3	1.5	0.40	2.5	1.7	1.6	38.8
200KBE031+L	237	328	3	1.5	0.39	2.6	1.7	1.7	47
200KBE3401+L	237	328	3	1	0.36	2.8	1.9	1.8	61.9
200KBE3502+L	237	333	3	1.5	0.39	2.6	1.7	1.7	51.9
200KBE3501+L	249	341	5	1.5	0.33	3.0	2.0	2.0	59.8
200KBE42+L	242	345	4	1.5	0.40	2.5	1.7	1.6	52.6
HR200KBE52+L	242	348	4	1.5	0.41	2.5	1.7	1.6	88.3

Note * Bearings marked * are inch design.

DOUBLE-ROW TAPERED ROLLER BEARINGS

KBE (TDO) Type, Double Cup, Single Cones

Bore Diameter 200.025 – 206.375 mm

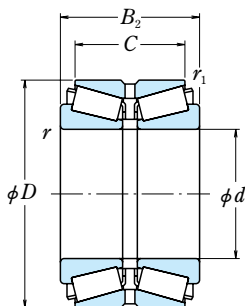

<i>d</i>	Boundary Dimensions (mm/inch)					Basic Load Ratings			
	<i>D</i>	<i>B</i> ₂	<i>C</i>	<i>r</i> min.	<i>r</i> ₁ min.	<i>C</i> _r (kN)	<i>C</i> _{0r}	<i>C</i> _r (kgf)	<i>C</i> _{0r}
200.025 7.8750	355.600 14.0000	152.400 6.0000	111.125 4.3750	6.8	1.5	1 190	2 470	122 000	252 000
	355.600 14.0000	158.750 6.2500	117.475 4.6250	6.8	0.8	1 190	2 470	122 000	252 000
	384.175 15.1250	238.125 9.3750	193.675 7.6250	6.4	1.5	2 090	4 450	213 000	455 000
201.612 7.9375	368.300 14.5000	193.675 7.6250	136.525 5.3750	3.3	1.5	1 500	2 690	153 000	274 000
203.200 8.0000	276.225 10.8750	90.485 3.5624	73.025 2.8750	3.5	0.8	580	1 240	59 000	127 000
	282.575 11.1250	101.600 4.0000	82.550 3.2500	3.5	0.8	630	1 600	64 000	163 000
	292.100 11.5000	125.415 4.9376	101.600 4.0000	3.5	1.5	930	2 100	94 500	214 000
	317.500 12.5000	127.000 5.0000	88.900 3.5000	4.0	1.5	790	1 450	80 500	148 000
	317.500 12.5000	146.050 5.7500	111.125 4.3750	4.3	1.5	990	2 120	101 000	216 000
	319.976 12.5975	146.050 5.7500	111.125 4.3750	4.3	1.5	990	2 120	101 000	216 000
	368.300 14.5000	193.675 7.6250	136.525 5.3750	3.3	1.5	1 500	2 690	153 000	274 000
206	283	102	83	4	1.5	580	1 430	59 000	146 000
206.375 8.1250	282.575 11.1250	101.600 4.0000	82.550 3.2500	3.5	0.8	630	1 600	64 000	163 000
	317.500 12.5000	127.000 5.0000	88.900 3.5000	4.0	1.5	790	1 450	80 500	148 000
	336.550 13.2500	211.138 8.3125	169.862 6.6875	3.3	1.5	1 790	3 800	182 000	390 000

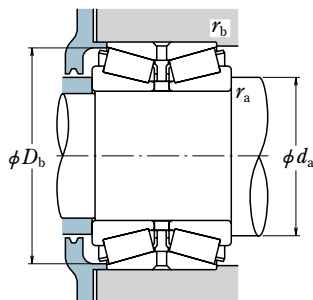

Dynamic Equivalent Load

$$P = XF_r + YF_a$$

$F_a/F_r \leq e$		$F_a/F_r > e$	
X	Y	X	Y
1	Y_3	0.67	Y_2

Static Equivalent Load

$$P_0 = F_r + Y_0 F_a$$

The values of e , Y_2 , Y_3 , and Y_0 are given in the table below.

Bearing Numbers	Abutment and Fillet Dimensions (mm)				Constant e	Axial Load Factors			Mass (kg) approx.
	d_a	D_b	r_a max.	r_b max.		Y_2	Y_3	Y_0	
* EE130787 / 131401D+L	250	340	6.8	1.5	0.33	3.0	2.0	2.0	60.3
* EE130787 / 131402D+L	250	341	6.8	0.8	0.33	3.0	2.0	2.0	62.4
* H247535 / H247510D+L	258	369	6.4	1.5	0.33	3.0	2.0	2.0	122
* EE420793 / 421451D+L	246	353	3.3	1.5	0.42	2.4	1.6	1.6	77.2
* LM241149 / LM241110D+L	224	269	3.5	0.8	0.32	3.2	2.1	2.1	13.9
* 67983 / 67920D+L	230	276	3.5	0.8	0.51	2.0	1.3	1.3	19
* M241547 / M241510D+L	229	283	3.5	1.5	0.33	3.0	2.0	2.0	25.7
* EE132083 / 132126D+L	232	302	4.0	1.5	0.31	3.2	2.1	2.1	30.6
* 93800 / 93127D+L	237	306	4.3	1.5	0.52	1.9	1.3	1.3	39
* 93800 / 93128D+L	237	307	4.3	1.5	0.52	1.9	1.3	1.3	40.5
* EE420801 / 421451D+L	246	353	3.3	1.5	0.42	2.4	1.6	1.6	76.4
206KBE2801+L	231	275	3	1.5	0.51	2.0	1.3	1.3	18.1
* 67985 / 67920D+L	231	276	3.5	0.8	0.51	2.0	1.3	1.3	18.2
* EE132084 / 132126D+L	234	302	4.0	1.5	0.31	3.2	2.1	2.1	29.6
* H242649 / H242610D+L	242	325	3.3	1.5	0.33	3.0	2.0	2.0	68.1

Note * Bearings marked * are inch design.

DOUBLE-ROW TAPERED ROLLER BEARINGS

KBE (TDO) Type, Double Cup, Single Cones

Bore Diameter 209.550 – 225.425 mm

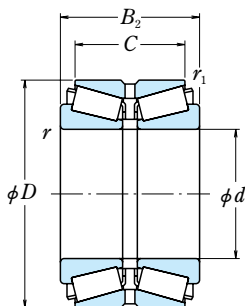

<i>d</i>	Boundary Dimensions (mm/inch)					Basic Load Ratings			
	<i>D</i>	<i>B</i> ₂	<i>C</i>	<i>r</i> min.	<i>r</i> ₁ min.	(kN)		(kgf)	
						<i>C</i> _r	<i>C</i> _{0r}	<i>C</i> _r	<i>C</i> _{0r}
209.550 8.2500	317.500 12.5000	146.050 5.7500	111.125 4.3750	4.3	1.5	990	2 120	101 000	216 000
	333.375 13.1250	149.225 5.8750	114.300 4.5000	6.4	1.5	1 180	2 380	120 000	243 000
	355.600 14.0000	152.400 6.0000	111.125 4.3750	7.0	1.5	1 030	2 340	105 000	239 000
210	300	110	85	1	1	735	1 550	75 000	158 000
	355	116	103	4	1.5	905	1 520	92 500	155 000
	360	190	160	5	1.5	1 620	3 200	165 000	325 000
212.725 8.3750	285.750 11.2500	98.425 3.8750	76.200 3.0000	3.5	0.8	600	1 510	61 000	154 000
	215.900 8.5000	285.750 11.2500	98.425 3.8750	76.200 3.0000	3.5	0.8	600	1 510	61 000
355.600 14.0000		152.400 6.0000	111.125 4.3750	6.8	1.5	1 190	2 470	122 000	252 000
406.400 16.0000		195.262 7.6875	147.638 5.8125	6.4	1.5	2 040	3 600	208 000	365 000
220	300	110	88	3	1	730	1 710	74 500	174 000
	340	90	80	4	1.5	695	1 280	71 000	131 000
	340	113	90	4	1.5	920	1 830	93 500	187 000
	370	120	107	5	1.5	1 110	1 940	113 000	198 000
	370	150	120	5	1.5	1 460	2 760	149 000	282 000
	400	150	114	5	1.5	1 390	2 300	142 000	235 000
400	158	122	5	1.5	1 390	2 300	142 000	235 000	
220.662 8.6875	314.325 12.3750	131.762 5.1875	106.362 4.1875	6.4	1.5	1 020	2 390	104 000	243 000
	225.425 8.8750	355.600 14.0000	152.400 6.0000	111.125 4.3750	6.8	1.5	1 190	2 470	122 000
400.050 15.7500		187.325 7.3750	136.525 5.3750	1.5	1.5	1 620	3 000	165 000	310 000

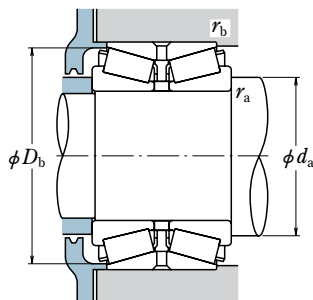

Dynamic Equivalent Load

$$P = XF_r + YF_a$$

$F_a/F_r \leq e$		$F_a/F_r > e$	
X	Y	X	Y
1	Y_3	0.67	Y_2

Static Equivalent Load

$$P_0 = F_r + Y_0 F_a$$

The values of e , Y_2 , Y_3 , and Y_0 are given in the table below.

Bearing Numbers	Abutment and Fillet Dimensions (mm)				Constant e	Axial Load Factors			Mass (kg) approx.
	d_a	D_b	r_a max.	r_b max.		Y_2	Y_3	Y_0	
* 93825 / 93127D+L	240	306	4.3	1.5	0.52	1.9	1.3	1.3	37.1
* HM743345 / HM743310D+L	247	322	6.4	1.5	0.44	2.3	1.5	1.5	45.3
* 96825 / 96140D+L	260	342	7.0	1.5	0.59	1.7	1.1	1.1	58.3
210KBE3001+L	233	291	0.8	0.8	0.38	2.6	1.8	1.7	22.6
210KBE31+L	248	342	3	1.5	0.46	2.2	1.5	1.4	41.7
210KBE3601+L	251	348	3	1	0.39	2.6	1.8	1.7	74.7
* LM742745 / LM742710D+L	237	280	3.5	0.8	0.48	2.1	1.4	1.4	16.8
* LM742749 / LM742710D+L	239	280	3.5	0.8	0.48	2.1	1.4	1.4	16
* EE130851 / 131401D+L	258	340	6.8	1.5	0.33	3.0	2.0	2.0	54.1
* EE820085 / 820161D+L	267	389	6.4	1.5	0.39	2.5	1.7	1.7	101
220KBE3001+L	244	293	2.5	1	0.37	2.7	1.8	1.8	21.2
220KBE30+L	253	328	3	1.5	0.40	2.5	1.7	1.6	27.9
220KBE030+L	255	329	3	1.5	0.40	2.5	1.7	1.6	34.7
220KBE31+L	257	353	4	1.5	0.39	2.6	1.7	1.7	48.3
220KBE031+L	260	355	4	1.5	0.39	2.6	1.7	1.7	60.2
220KBE042+L	266	381	4	1.5	0.40	2.5	1.7	1.6	70.9
220KBE42+L	266	381	4	1.5	0.40	2.5	1.7	1.6	74.2
* M244249 / M244210D+L	250	305	6.4	1.5	0.33	3.0	2.0	2.0	30.9
* EE130889 / 131401D+L	263	340	6.8	1.5	0.33	3.0	2.0	2.0	50.2
* EE430888 / 431576D+L	266	379	1.5	1.5	0.44	2.3	1.5	1.5	88

Note * Bearings marked * are inch design.

DOUBLE-ROW TAPERED ROLLER BEARINGS

KBE (TDO) Type, Double Cup, Single Cones

Bore Diameter 228.600 – 234.950 mm

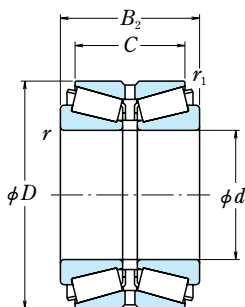

<i>d</i>	Boundary Dimensions (mm/inch)					Basic Load Ratings (kN) (kgf)			
	<i>D</i>	<i>B</i> ₂	<i>C</i>	<i>r</i> min.	<i>r</i> ₁ min.	<i>C</i> _r	<i>C</i> _{0r}	<i>C</i> _r	<i>C</i> _{0r}
228.600 9.0000	327.025 12.8750	114.300 4.5000	82.550 3.2500	6.4	1.5	805	1 880	82 000	192 000
	355.600 14.0000	152.400 6.0000	111.125 4.3750	6.8	1.5	1 190	2 470	122 000	252 000
	355.600 14.0000	152.400 6.0000	111.125 4.3750	7.0	1.5	1 030	2 340	105 000	239 000
	355.600 14.0000	152.400 6.0000	114.300 4.5000	6.4	1.5	1 310	2 590	134 000	264 000
	355.600 14.0000	158.750 6.2500	117.475 4.6250	6.8	0.8	1 190	2 470	122 000	252 000
	400.050 15.7500	187.325 7.3750	136.525 5.3750	10.4	1.5	1 620	3 000	165 000	310 000
	425.450 16.7500	209.550 8.2500	158.750 6.2500	7.0	1.5	2 200	4 000	224 000	405 000
230	380	200	160	5	1.5	1 930	3 800	197 000	390 000
	400	188	136	7.5	1.5	1 620	3 000	165 000	310 000
	410	180	120	5	1.5	1 770	3 150	181 000	320 000
234.950 9.2500	311.150 12.2500	98.425 3.8750	73.025 2.8750	3.5	0.8	640	1 610	65 000	164 000
	327.025 12.8750	114.300 4.5000	82.550 3.2500	6.4	1.5	805	1 880	82 000	192 000
	355.600 14.0000	152.400 6.0000	111.125 4.3750	7.0	1.5	1 030	2 340	105 000	239 000
	384.175 15.1250	238.125 9.3750	193.675 7.6250	6.4	1.5	2 090	4 450	213 000	455 000

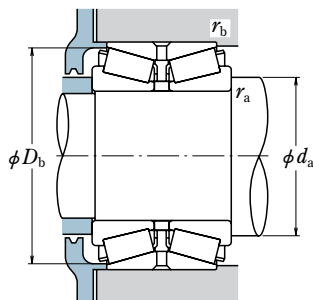

Dynamic Equivalent Load

$$P = XF_r + YF_a$$

$F_a/F_r \leq e$		$F_a/F_r > e$	
X	Y	X	Y
1	Y_3	0.67	Y_2

Static Equivalent Load

$$P_0 = F_r + Y_0 F_a$$

The values of e , Y_2 , Y_3 , and Y_0 are given in the table below.

Bearing Numbers	Abutment and Fillet Dimensions (mm)				Constant e	Axial Load Factors			Mass (kg) approx.
	d_a	D_b	r_a max.	r_b max.		Y_2	Y_3	Y_0	
* 8573 / 8520D+L	261	316	6.4	1.5	0.41	2.5	1.7	1.6	28
* EE130902 / 131401D+L	265	340	6.8	1.5	0.33	3.0	2.0	2.0	48.8
* 96900 / 96140D+L	270	342	7.0	1.5	0.59	1.7	1.1	1.1	51
* HM746646 / HM746610D+L	266	345	6.4	1.5	0.47	2.1	1.4	1.4	49.1
* EE130902 / 131402D+L	265	341	6.8	0.8	0.33	3.0	2.0	2.0	50.4
* EE430900 / 431576D+L	277	379	10.4	1.5	0.44	2.3	1.5	1.5	86.1
* EE700091 / 700168D+L	281	406	7.0	1.5	0.33	3.0	2.0	2.0	118
230KBE3801+L	270	367	4	1.5	0.33	3.0	2.0	2.0	80.9
230KBE4002+L	274	379	6	1	0.44	2.3	1.5	1.5	85.8
230KBE4101+L	278	395	4	1.5	0.55	1.8	1.2	1.2	91.5
* LM446349 / LM446310D+L	259	304	3.5	0.8	0.36	2.8	1.9	1.8	18.8
* 8575 / 8520D+L	264	316	6.4	1.5	0.41	2.5	1.7	1.6	26.1
* 96925 / 96140D+L	273	342	7.0	1.5	0.59	1.7	1.1	1.1	48.3
* H247549 / H247510D+L	276	369	6.4	1.5	0.33	3.0	2.0	2.0	99.7

Note * Bearings marked * are inch design.

DOUBLE-ROW TAPERED ROLLER BEARINGS

KBE (TDO) Type, Double Cup, Single Cones

Bore Diameter 240 – 250 mm

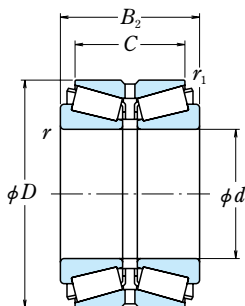

<i>d</i>	Boundary Dimensions (mm/inch)					Basic Load Ratings			
	<i>D</i>	<i>B</i> ₂	<i>C</i>	<i>r</i> min.	<i>r</i> ₁ min.	(kN)		(kgf)	
						<i>C</i> _r	<i>C</i> _{0r}	<i>C</i> _r	<i>C</i> _{0r}
240	360	92	82	4	1.5	780	1 490	79 500	152 000
	360	115	92	4	1.5	1 020	2 040	104 000	208 000
	360	170	142	4	1	1 350	2 870	138 000	293 000
	400	128	114	5	1.5	1 180	2 190	120 000	223 000
	400	160	128	5	1.5	1 620	3 050	165 000	310 000
	407	216	185	6	1.5	2 220	4 450	226 000	455 000
241.300 9.5000	327.025 12.8750	114.300 4.5000	82.550 3.2500	6.4	1.5	805	1 880	82 000	192 000
	349.148 13.7460	127.000 5.0000	101.600 4.0000	6.4	1.5	980	2 130	100 000	217 000
	350.838 13.8125	127.000 5.0000	101.600 4.0000	6.4	1.5	980	2 130	100 000	217 000
	355.498 13.9960	127.000 5.0000	101.600 4.0000	6.4	1.5	980	2 130	100 000	217 000
	393.700 15.5000	157.162 6.1875	109.538 4.3125	6.4	1.5	1 200	2 570	123 000	262 000
	406.400 16.0000	155.580 6.1252	107.950 4.2500	6.4	1.5	1 200	2 570	123 000	262 000
	406.400 16.0000	215.900 8.5000	184.150 7.2500	6.4	1.5	2 220	4 450	226 000	455 000
	444.500 17.5000	209.550 8.2500	158.750 6.2500	6.4	1.5	2 410	4 500	246 000	455 000
	488.950 19.2500	254.000 10.0000	196.850 7.7500	6.4	1.5	2 950	5 700	300 000	580 000
	244.475 9.6250	381.000 15.0000	171.450 6.7500	127.000 5.0000	6.4	1.5	1 410	3 100	144 000
249.250 9.8130		381.000 15.0000	171.450 6.7500	127.000 5.0000	6.4	1.5	1 410	3 100	144 000
	250	380	98	87	4	1	795	1 460	81 500

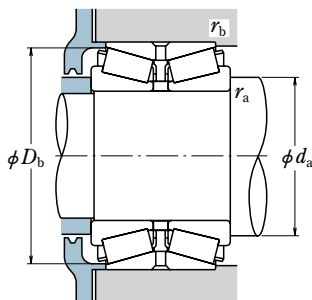

Dynamic Equivalent Load

$$P = X F_r + Y F_a$$

$F_a/F_r \leq e$		$F_a/F_r > e$	
X	Y	X	Y
1	Y_3	0.67	Y_2

Static Equivalent Load

$$P_0 = F_r + Y_0 F_a$$

The values of e , Y_2 , Y_3 , and Y_0 are given in the table below.

Bearing Numbers	Abutment and Fillet Dimensions (mm)				Constant e	Axial Load Factors			Mass (kg) approx.
	d_a	D_b	r_a max.	r_b max.		Y_2	Y_3	Y_0	
240KBE30+L	272	348	3	1.5	0.39	2.6	1.7	1.7	30.1
240KBE030+L	272	348	3	1.5	0.35	2.9	1.9	1.9	37.3
240KBE3601+L	274	351	3	1	0.39	2.6	1.7	1.7	54.1
240KBE31+L	284	386	4	1.5	0.43	2.3	1.6	1.5	60
240KBE031+L	282	385	4	1.5	0.39	2.6	1.7	1.7	73.6
240KBE4002+L	285	393	5	1.5	0.33	3.0	2.0	2.0	106
* 8578 / 8520D+L	267	316	6.4	1.5	0.41	2.5	1.7	1.6	23.9
* EE127095 / 127136D+L	274	338	6.4	1.5	0.35	2.8	1.9	1.9	36.1
* EE127095 / 127137D+L	274	338	6.4	1.5	0.35	2.8	1.9	1.9	36.9
* EE127095 / 127139D+L	274	341	6.4	1.5	0.35	2.8	1.9	1.9	38.9
* EE275095 / 275156D+L	293	382	6.4	1.5	0.40	2.5	1.7	1.6	68
* EE275095 / 275161D+L	293	389	6.4	1.5	0.40	2.5	1.7	1.6	74.2
* H249148 / H249111D+L	287	392	6.4	1.5	0.33	3.0	2.0	2.0	105
* EE923095 / 923176D+L	295	423	6.4	1.5	0.34	3.0	2.0	2.0	133
* EE295950 / 295192D+L	315	469	6.4	1.5	0.31	3.2	2.2	2.1	207
* EE126097 / 126151D+L	286	367	6.4	1.5	0.52	1.9	1.3	1.3	65.1
* EE126098 / 126151D+L	288	367	6.4	1.5	0.52	1.9	1.3	1.3	62.6
250KBE3801+L	285	369	3	1	0.40	2.5	1.7	1.6	35.5

Note * Bearings marked * are inch design.

DOUBLE-ROW TAPERED ROLLER BEARINGS

KBE (TDO) Type, Double Cup, Single Cones

Bore Diameter 254.000 – 260.350 mm

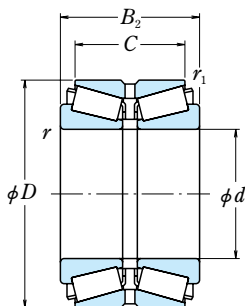

<i>d</i>	Boundary Dimensions (mm/inch)					Basic Load Ratings			
	<i>D</i>	<i>B</i> ₂	<i>C</i>	<i>r</i> min.	<i>r</i> ₁ min.	<i>C</i> _r (kN)	<i>C</i> _{0r} (kgf)	<i>C</i> _r	<i>C</i> _{0r}
254.000 10.0000	323.850 12.7500	63.500 2.5000	50.800 2.0000	1.5	0.8	263	760	26 800	77 500
	347.662 13.6875	95.250 3.7500	69.850 2.7500	3.5	1.5	755	1 610	77 000	164 000
	358.775 14.1250	152.400 6.0000	117.475 4.6250	3.5	1.5	1 300	3 100	133 000	315 000
	365.125 14.3750	130.175 5.1250	98.425 3.8750	6.4	1.5	990	2 200	101 000	224 000
	393.700 15.5000	157.162 6.1875	109.538 4.3125	6.4	1.5	1 200	2 570	123 000	262 000
	422.275 16.6250	173.038 6.8125	128.588 5.0625	6.8	1.5	1 670	3 200	170 000	325 000
	422.275 16.6250	173.038 6.8125	128.588 5.0625	6.8	1.5	1 950	3 700	199 000	375 000
	422.275 16.6250	178.592 7.0312	139.700 5.5000	6.8	1.5	1 950	3 700	199 000	375 000
	431.724 16.9970	173.038 6.8125	128.588 5.0625	6.8	1.5	1 670	3 200	170 000	325 000
	495.300 19.5000	168.595 6.6376	127.000 5.0000	6.4	1.5	1 840	3 550	188 000	365 000
260	400	104	92	5	1.5	895	1 670	91 500	171 000
	400	130	104	5	1.5	1 210	2 460	123 000	251 000
	400	155	108	9.5	1.6	1 260	2 440	128 000	249 000
	440	144	128	5	1.5	1 540	2 760	157 000	282 000
	440	172	145	5	1.5	1 870	3 500	190 000	360 000
	440	180	144	5	1.5	2 110	4 150	216 000	425 000
	445	144	128	5	1.5	1 540	2 760	157 000	282 000
260.350 10.2500	365.125 14.3750	130.175 5.1250	98.425 3.8750	6.4	1.5	990	2 200	101 000	224 000
	400.050 15.7500	155.575 6.1250	107.950 4.2500	9.7	1.5	1 260	2 440	128 000	249 000

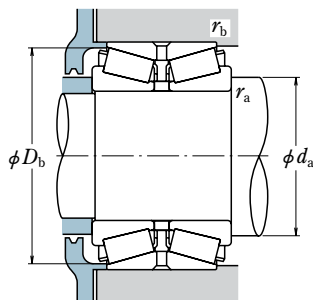

Dynamic Equivalent Load

$$P = X F_r + Y F_a$$

$F_a/F_r \leq e$		$F_a/F_r > e$	
X	Y	X	Y
1	Y_3	0.67	Y_2

Static Equivalent Load

$$P_0 = F_r + Y_0 F_a$$

The values of e , Y_2 , Y_3 , and Y_0 are given in the table below.

Bearing Numbers	Abutment and Fillet Dimensions (mm)				Constant e	Axial Load Factors			Mass (kg) approx.
	d_a	D_b	r_a max.	r_b max.		Y_2	Y_3	Y_0	
* 29875 / 29820D+L	276	315	1.5	0.8	0.35	2.9	1.9	1.9	12.4
* LM249748 / LM249710D+L	278	336	3.5	1.5	0.33	3.0	2.0	2.0	23.1
* M249749 / M249710D+L	284	348	3.5	1.5	0.33	3.0	2.0	2.0	44.6
* EE134100 / 134144D+L	289	354	6.4	1.5	0.37	2.7	1.8	1.8	39.8
* EE275100 / 275156D+L	299	382	6.4	1.5	0.40	2.5	1.7	1.6	61.9
* EE551002 / 551664D+L	299	403	6.8	1.5	0.33	3.0	2.0	2.0	85.6
* HM252343 / HM252311D+L	301	408	6.8	1.5	0.33	3.0	2.0	2.0	86.6
* HM252343 / HM252310D+L	301	408	6.8	1.5	0.33	3.0	2.0	2.0	89.7
* EE551002 / 551701D+L	299	408	6.8	1.5	0.33	3.0	2.0	2.0	91.9
* EE941002 / 941953D+L	327	471	6.4	1.5	0.40	2.5	1.7	1.7	137
260KBE30+L	298	385	4	1.5	0.40	2.5	1.7	1.6	43.4
260KBE030+L	300	387	4	1.5	0.40	2.5	1.7	1.6	54.1
260KBE4001+L	300	383	9.5	1.6	0.39	2.5	1.7	1.7	58
260KBE31+L	306	423	4	1.5	0.39	2.6	1.7	1.7	82.5
260KBE4401+L	305	422	4	1.5	0.38	2.6	1.8	1.7	98.1
260KBE031+L	308	423	4	1.5	0.39	2.6	1.7	1.7	104
260KBE4403+L	306	426	4	1.5	0.39	2.6	1.7	1.7	86
* EE134102 / 134144D+L	293	354	6.4	1.5	0.37	2.7	1.8	1.8	37.2
* EE221026 / 221576D+L	300	383	9.7	1.5	0.39	2.5	1.7	1.7	58.3

Note * Bearings marked * are inch design.

DOUBLE-ROW TAPERED ROLLER BEARINGS

KBE (TDO) Type, Double Cup, Single Cones

Bore Diameter 260.350 – 270 mm

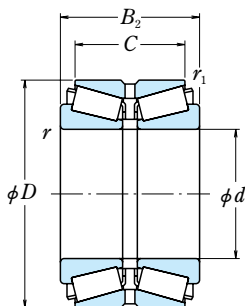

d	Boundary Dimensions (mm/inch)					Basic Load Ratings (kN) (kgf)			
	D	B_2	C	r min.	r_1 min.	C_r	C_{0r}	C_r	C_{0r}
260.350 10.2500	406.400 16.0000	149.225 5.8750	117.475 4.6250	3.3	1.5	1 290	2 870	131 000	292 000
	422.275 16.6250	173.038 6.8125	128.588 5.0625	6.8	1.5	1 950	3 700	199 000	375 000
	422.275 16.6250	178.592 7.0312	139.700 5.5000	6.8	1.5	1 950	3 700	199 000	375 000
	422.275 16.6250	178.598 7.0314	139.700 5.5000	6.8	1.5	1 670	3 200	170 000	325 000
	488.950 19.2500	254.000 10.0000	196.850 7.7500	6.4	1.5	2 950	5 700	300 000	580 000
263.525 10.3750	355.600 14.0000	127.000 5.0000	101.600 4.0000	3.5	1.5	865	2 260	88 000	230 000
266.700 10.5000	355.600 14.0000	127.000 5.0000	101.600 4.0000	3.5	1.5	1 060	2 520	108 000	257 000
	355.600 14.0000	127.000 5.0000	101.600 4.0000	3.5	1.5	865	2 260	88 000	230 000
	357.200 14.0630	127.000 5.0000	101.600 4.0000	3.5	1.5	1 060	2 520	108 000	257 000
	393.700 15.5000	157.162 6.1875	109.538 4.3125	6.4	1.5	1 200	2 570	123 000	262 000
	406.400 16.0000	155.575 6.1250	107.950 4.2500	6.4	1.5	1 200	2 570	123 000	262 000
	422.275 16.6250	178.598 7.0314	139.700 5.5000	6.8	1.5	1 670	3 200	170 000	325 000
	431.724 16.9970	173.038 6.8125	128.588 5.0625	6.8	1.5	1 670	3 200	170 000	325 000
269.875 10.6250	381.000 15.0000	158.750 6.2500	123.825 4.8750	6.4	1.5	1 360	3 200	138 000	325 000
270	355	120	95	3	1	890	2 260	90 500	230 000

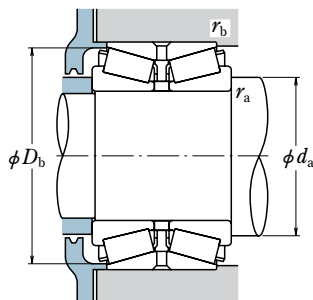

Dynamic Equivalent Load

$$P = XF_r + YF_a$$

$F_a/F_r \leq e$		$F_a/F_r > e$	
X	Y	X	Y
1	Y_3	0.67	Y_2

Static Equivalent Load

$$P_0 = F_r + Y_0 F_a$$

The values of e , Y_2 , Y_3 , and Y_0 are given in the table below.

Bearing Numbers	Abutment and Fillet Dimensions (mm)				Constant e	Axial Load Factors			Mass (kg) approx.
	d_a	D_b	r_a max.	r_b max.		Y_2	Y_3	Y_0	
* EE128102 / 128160D+L	302	391	3.3	1.5	0.39	2.6	1.8	1.7	66.8
* HM252349 / HM252311D+L	304	408	6.8	1.5	0.33	3.0	2.0	2.0	83.1
* HM252349 / HM252310D+L	304	408	6.8	1.5	0.33	3.0	2.0	2.0	86.1
* EE551026 / 551663D+L	302	404	6.8	1.5	0.33	3.0	2.0	2.0	85.3
* EE295102 / 295192D+L	325	469	6.4	1.5	0.31	3.2	2.2	2.1	193
* 76587 / 76520D+L	293	347	3.5	1.5	0.36	2.8	1.9	1.8	33.2
* LM451349 / LM451310D+L	292	348	3.5	1.5	0.36	2.8	1.9	1.8	31.2
* 76590 / 76520D+L	294	347	3.5	1.5	0.36	2.8	1.9	1.8	31.9
* LM451349 / LM451312D+L	292	348	3.5	1.5	0.36	2.8	1.9	1.8	32
* EE275105 / 275156D+L	306	382	6.4	1.5	0.40	2.5	1.7	1.6	56.6
* EE275105 / 275161D+L	306	389	6.4	1.5	0.40	2.5	1.7	1.6	62.8
* EE551050 / 551663D+L	306	404	6.8	1.5	0.33	3.0	2.0	2.0	81.6
* EE551050 / 551701D+L	306	408	6.8	1.5	0.33	3.0	2.0	2.0	84.9
* M252349 / M252310D+L	304	370	6.4	1.5	0.33	3.0	2.0	2.0	51.6
270KBE3501+L	295	347	2.5	1	0.35	2.9	1.9	1.9	29.3

Note * Bearings marked * are inch design.

DOUBLE-ROW TAPERED ROLLER BEARINGS

KBE (TDO) Type, Double Cup, Single Cones

Bore Diameter 273.050 – 289 mm

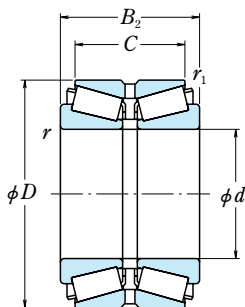

<i>d</i>	Boundary Dimensions (mm/inch)					Basic Load Ratings			
	<i>D</i>	<i>B</i> ₂	<i>C</i>	<i>r</i> min.	<i>r</i> ₁ min.	(kN)		(kgf)	
						<i>C</i> _r	<i>C</i> _{0r}	<i>C</i> _r	<i>C</i> _{0r}
273.050 10.7500	393.700 15.5000	157.162 6.1875	109.538 4.3125	6.4	1.5	1 200	2 570	123 000	262 000
	406.400 16.0000	155.575 6.1250	107.950 4.2500	6.4	1.5	1 200	2 570	123 000	262 000
273.060 10.7504	422.280 16.6252	178.590 7.0311	177.800 7.0000	8.0	4.0	1 840	4 050	188 000	410 000
279.400 11.0000	469.900 18.5000	200.025 7.8750	149.225 5.8750	9.7	1.5	2 030	4 150	207 000	420 000
	488.950 19.2500	254.000 10.0000	196.850 7.7500	1.3	1.5	2 950	5 700	300 000	580 000
280	400	150	120	6	1	1 290	2 870	131 000	292 000
	420	106	94	5	1.5	915	1 820	93 500	185 000
	420	133	106	5	1.5	1 350	2 760	137 000	282 000
	425	133	106	5	2	1 350	2 760	137 000	282 000
	460	146	130	6	2	1 660	3 000	169 000	305 000
	460	183	146	6	2	2 170	4 250	221 000	430 000
	500	195	145	6	1.5	2 470	4 500	252 000	460 000
280.000 11.0236	406.400 16.0000	149.225 5.8750	117.475 4.6250	6.4	1.5	1 290	2 870	131 000	292 000
280.192 11.0312	406.400 16.0000	120.650 4.7500	85.725 3.3750	6.8	1.5	890	1 740	90 500	178 000
	406.400 16.0000	149.225 5.8750	117.475 4.6250	6.8	1.5	1 290	2 870	131 000	292 000
285.750 11.2500	358.775 14.1250	76.200 3.0000	53.975 2.1250	3.5	1.5	430	1 150	44 000	117 000
	380.898 14.9960	139.700 5.5000	107.950 4.2500	3.5	1.5	1 060	2 990	108 000	305 000
	469.900 18.5000	177.785 6.9994	127.000 5.0000	9.7	1.5	1 890	3 600	192 000	370 000
288.925 11.3750	406.400 16.0000	165.100 6.5000	130.175 5.1250	6.4	1.5	1 530	3 650	156 000	375 000
289	422	186	146	6	1.5	2 040	4 650	208 000	470 000

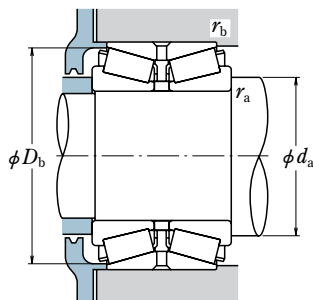

Dynamic Equivalent Load

$$P = XF_r + YF_a$$

$F_a/F_r \leq e$		$F_a/F_r > e$	
X	Y	X	Y
1	Y_3	0.67	Y_2

Static Equivalent Load

$$P_0 = F_r + Y_0 F_a$$

The values of e , Y_2 , Y_3 , and Y_0 are given in the table below.

Bearing Numbers	Abutment and Fillet Dimensions (mm)				Constant e	Axial Load Factors			Mass (kg) approx.
	d_a	D_b	r_a max.	r_b max.		Y_2	Y_3	Y_0	
* EE275108 / 275156D+L	309	382	6.4	1.5	0.40	2.5	1.7	1.6	53.3
* EE275108 / 275161D+L	309	389	6.4	1.5	0.40	2.5	1.7	1.6	59.5
* 273KBE4251+L	318	409	8.0	4.0	0.33	3.0	2.0	2.0	88.5
* EE722110 / 722186D+L	336	451	9.7	1.5	0.38	2.7	1.8	1.7	127
* EE295110 / 295192D+L	329	469	1.3	1.5	0.31	3.2	2.2	2.1	177
280KBE4001+L	315	389	5	1	0.39	2.6	1.8	1.7	54.2
280KBE30+L	318	406	4	1.5	0.44	2.3	1.5	1.5	46.7
280KBE030+L	319	407	4	1.5	0.40	2.5	1.7	1.6	59.7
280KBE4202+L	319	409	4	2	0.40	2.5	1.7	1.6	62.3
280KBE31+L	323	440	5	2	0.39	2.6	1.7	1.7	88.2
280KBE031+L	327	442	5	2	0.39	2.6	1.7	1.7	109
280KBE5001+L	335	479	5	1.5	0.45	2.2	1.5	1.5	155
* EE128114 / 128160D+L	315	391	6.4	1.5	0.39	2.6	1.8	1.7	56.9
* EE101103 / 101601D+L	315	391	6.8	1.5	0.41	2.5	1.7	1.6	42.5
* EE128111 / 128160D+L	316	391	6.8	1.5	0.39	2.6	1.8	1.7	56.8
* 545112 / 545142D+L	307	348	3.5	1.5	0.49	2.0	1.4	1.3	15.8
* LM654649 / LM654610D+L	316	371	3.5	1.5	0.43	2.3	1.6	1.5	42
* EE921124 / 921851D+L	338	450	9.7	1.5	0.29	3.4	2.3	2.3	105
* M255449 / M255410D+L	324	395	6.4	1.5	0.34	3.0	2.0	2.0	61.7
289KBE4201+L	326	410	5	1.5	0.31	3.2	2.2	2.1	82.3

Note * Bearings marked * are inch design.

DOUBLE-ROW TAPERED ROLLER BEARINGS

KBE (TDO) Type, Double Cup, Single Cones

Bore Diameter 290 – 310 mm

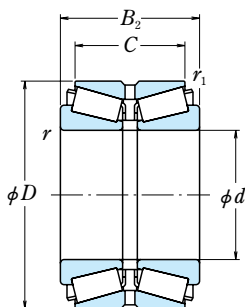

d	Boundary Dimensions (mm/inch)					Basic Load Ratings (kN) (kgf)			
	D	B_2	C	r min.	r_1 min.	C_r	C_{0r}	C_r	C_{0r}
290	400	120	90	5	1.5	1 050	2 380	107 000	243 000
	405	165	130	5.5	1	1 530	3 650	156 000	375 000
292.100 11.5000	469.900	200.025	149.225	9.7	1.5	2 030	4 150	207 000	420 000
	18.5000	7.8750	5.8750						
	520.700	228.600	165.100	6.4	1.5	2 660	4 900	271 000	500 000
	20.5000	9.0000	6.5000						
	558.800	298.450	222.250	6.4	1.5	4 250	8 200	435 000	840 000
	22.0000	11.7500	8.7500						
298.450 11.7500	444.500	146.050	98.425	8.0	1.5	1 170	2 280	120 000	233 000
	17.5000	5.7500	3.8750						
300	420	148	118	5	2	1 290	2 960	132 000	300 000
	460	118	105	5	1.5	1 130	2 180	115 000	222 000
	460	148	118	5	1.5	1 570	3 300	160 000	340 000
	500	160	142	6	2	1 970	3 600	201 000	370 000
	500	200	160	6	2	2 530	5 000	258 000	510 000
	502	200	160	6	2	2 530	5 000	258 000	510 000
	600	310	220	6	1.5	4 450	7 900	455 000	805 000
300.038 11.8125	422.275	174.625	136.525	6.4	1.5	1 700	4 100	173 000	420 000
	16.6250	6.8750	5.3750						
304.800 12.0000	393.700	107.950	82.550	6.4	1.5	910	2 280	92 500	233 000
	15.5000	4.2500	3.2500						
	412.750	123.825	92.075	6.4	1.5	1 090	2 520	111 000	257 000
	16.2500	4.8750	3.6250						
	444.500	146.050	98.425	8.0	1.5	1 170	2 280	120 000	233 000
	17.5000	5.7500	3.8750						
	495.300	168.595	127.000	6.4	1.5	1 840	3 550	188 000	365 000
19.5000	6.6376	5.0000							
	495.300	196.850	146.050	16.0	1.5	2 130	4 300	217 000	440 000
	19.5000	7.7500	5.7500						
	558.800	298.450	222.250	1.3	1.5	4 250	8 200	435 000	840 000
	22.0000	11.7500	8.7500						
310	470	200	148	9.5	1.5	2 230	4 800	227 000	490 000

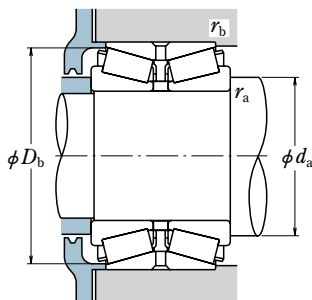

Dynamic Equivalent Load

$$P = XF_r + YF_a$$

$F_a/F_r \leq e$		$F_a/F_r > e$	
X	Y	X	Y
1	Y_3	0.67	Y_2

Static Equivalent Load

$$P_0 = F_r + Y_0 F_a$$

The values of e , Y_2 , Y_3 , and Y_0 are given in the table below.

Bearing Numbers	Abutment and Fillet Dimensions (mm)				Constant e	Axial Load Factors			Mass (kg) approx.
	d_a	D_b	r_a max.	r_b max.		Y_2	Y_3	Y_0	
290KBE4001+L	322	389	4	1.5	0.41	2.4	1.6	1.6	40.7
290KBE4002+L	324	395	5.5	1	0.34	3.0	2.0	2.0	59.9
* EE722115 / 722186D+L	342	451	9.7	1.5	0.38	2.7	1.8	1.7	118
* EE224115 / 224205D+L	345	492	6.4	1.5	0.33	3.1	2.1	2.0	180
* EE790114 / 790223D+L	362	537	6.4	1.5	0.39	2.5	1.7	1.7	312
* EE291175 / 291751D+L	339	427	8.0	1.5	0.38	2.7	1.8	1.7	63.9
300KBE4202+L	335	408	4	2	0.41	2.4	1.6	1.6	58.9
300KBE30+L	344	446	4	1.5	0.42	2.4	1.6	1.6	64.8
300KBE030+L	347	448	4	1.5	0.42	2.4	1.6	1.6	83.3
300KBE31+L	350	481	5	2	0.39	2.6	1.7	1.7	115
300KBE031+L	352	481	5	2	0.39	2.6	1.7	1.7	146
300KBE5002+L	352	482	5	2	0.39	2.6	1.7	1.7	148
300KBE6001+L	370	571	4	1	0.35	2.9	1.9	1.9	357
* HM256849 / HM256810D+L	337	411	6.4	1.5	0.34	3.0	2.0	2.0	70.6
* L357049 / L357010D+L	334	385	6.4	1.5	0.36	2.8	1.9	1.8	30
* EE109120 / 109163D+L	337	401	6.4	1.5	0.43	2.4	1.6	1.6	42.1
* EE291201 / 291751D+L	342	427	8.0	1.5	0.38	2.7	1.8	1.7	60.5
* EE941205 / 941953D+L	352	471	6.4	1.5	0.40	2.5	1.7	1.7	111
* EE724120 / 724196D+L	364	474	16.0	1.5	0.40	2.5	1.7	1.6	130
* EE790120-N1 / 790223D+L	364	537	1.3	1.5	0.39	2.5	1.7	1.7	298
310KBE4701+L	359	456	8	1.5	0.40	2.5	1.7	1.6	111

Note * Bearings marked * are inch design.

DOUBLE-ROW TAPERED ROLLER BEARINGS

KBE (TDO) Type, Double Cup, Single Cones

Bore Diameter 317.500 – 340 mm

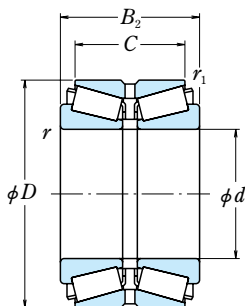

<i>d</i>	Boundary Dimensions (mm/inch)					Basic Load Ratings			
	<i>D</i>	<i>B</i> ₂	<i>C</i>	<i>r</i> min.	<i>r</i> ₁ min.	(kN)		(kgf)	
						<i>C</i> _r	<i>C</i> _{0r}	<i>C</i> _r	<i>C</i> _{0r}
317.500 12.5000	444.500 17.5000	146.050 5.7500	98.425 3.8750	8.0	1.5	1 170	2 280	120 000	233 000
	447.675 17.6250	180.975 7.1250	146.050 5.7500	3.5	1.5	1 920	4 700	196 000	480 000
320	480	121	108	5	1.5	1 310	2 550	134 000	260 000
	480	151	121	5	1.5	1 750	3 700	178 000	375 000
	480	215	163	5	1.5	2 580	5 850	263 000	595 000
	540	176	130	6	2	2 360	4 450	241 000	455 000
	540	176	157	6	2	2 430	4 600	248 000	470 000
	540	220	176	6	2	3 050	6 100	310 000	620 000
329.870 12.9870	533.400 21.0000	165.100 6.5000	114.300 4.5000	4.7	1.5	1 810	3 600	185 000	365 000
	533.400 21.0000	174.635 6.8754	123.825 4.8750	4.7	1.5	1 810	3 600	185 000	365 000
	546.100 21.5000	177.800 7.0000	152.400 6.0000	4.7	3.3	1 810	3 600	185 000	365 000
330	500	190	150	6	1.5	2 360	5 200	241 000	530 000
330.200 13.0000	482.600 19.0000	133.350 5.2500	88.900 3.5000	7.0	1.5	1 210	2 840	124 000	289 000
	482.600 19.0000	177.800 7.0000	127.000 5.0000	6.4	1.5	1 700	3 650	174 000	375 000
330.25	528	292	210	spec.	1	3 250	7 250	330 000	740 000
333.375 13.1250	469.900 18.5000	190.500 7.5000	152.400 6.0000	6.4	1.5	1 830	4 500	186 000	460 000
340	500	249.22	203.2	5	1.5	2 950	6 850	300 000	700 000
	520	133	118	6	2	1 580	3 150	161 000	320 000
	520	165	133	6	2	2 140	4 300	218 000	440 000
	580	190	169	6	2	2 690	5 150	274 000	525 000
	580	238	190	6	2	3 450	7 050	350 000	720 000
	580	305	241	6	2	4 700	10 200	480 000	1 040 000

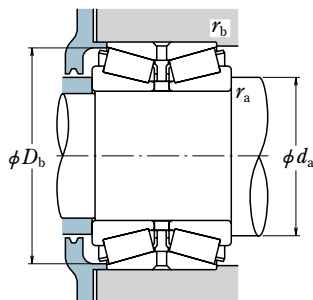

Dynamic Equivalent Load

$$P = X F_r + Y F_a$$

$F_a/F_r \leq e$		$F_a/F_r > e$	
X	Y	X	Y
1	Y_3	0.67	Y_2

Static Equivalent Load

$$P_0 = F_r + Y_0 F_a$$

The values of e , Y_2 , Y_3 , and Y_0 are given in the table below.

Bearing Numbers	Abutment and Fillet Dimensions (mm)				Constant e	Axial Load Factors			Mass (kg) approx.
	d_a	D_b	r_a max.	r_b max.		Y_2	Y_3	Y_0	
* EE291250 / 291751D+L	349	427	8.0	1.5	0.38	2.7	1.8	1.7	53.4
* HM259049 / HM259010D+L	353	435	3.5	1.5	0.33	3.0	2.0	2.0	83.6
320KBE30+L	359	462	4	1.5	0.40	2.5	1.7	1.6	70.9
320KBE030+L	362	464	4	1.5	0.40	2.5	1.7	1.6	88
320KBE4801+L	365	468	4	1.5	0.46	2.2	1.5	1.4	125
320KBE5401+L	375	516	4	2	0.39	2.6	1.7	1.7	153
320KBE31+L	375	520	5	2	0.39	2.6	1.7	1.7	153
320KBE031+L	379	520	5	2	0.39	2.6	1.7	1.7	190
* EE971298 / 972102D+L	383	510	4.7	1.5	0.33	3.0	2.0	2.0	125
* EE971298 / 972103D+L	383	510	4.7	1.5	0.33	3.0	2.0	2.0	130
* EE971298 / 972151D+L	383	517	4.7	3.3	0.33	3.0	2.0	2.0	151
330KBE5001+L	377	485	5	1.5	0.39	2.6	1.7	1.7	125
* EE161300 / 161901D+L	377	465	7.0	1.5	0.50	2.0	1.4	1.3	73.6
* EE526130 / 526191D+L	370	465	6.4	1.5	0.39	2.6	1.7	1.7	92.6
330KBE5202B+L	393	513	—	1	0.43	2.3	1.6	1.5	221
* HM261049 / HM261010D+L	375	457	6.4	1.5	0.39	2.6	1.7	1.7	94.9
340KBE5001+L	381	485	4	1.5	0.28	3.6	2.4	2.4	149
340KBE30+L	387	501	5	2	0.37	2.7	1.8	1.8	94.9
340KBE030A+L	386	503	5	2	0.39	2.6	1.7	1.7	118
340KBE31+L	399	554	5	2	0.39	2.6	1.7	1.7	194
340KBE031+L	401	557	5	2	0.39	2.6	1.7	1.7	240
340KBE5801+L	401	557	4	2	0.33	3.0	2.0	2.0	323

Note * Bearings marked * are inch design.

DOUBLE-ROW TAPERED ROLLER BEARINGS

KBE (TDO) Type, Double Cup, Single Cones

Bore Diameter 342.900 – 368.300 mm

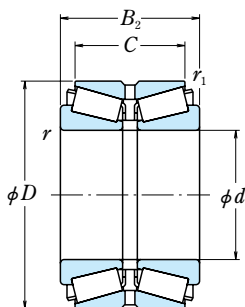

<i>d</i>	Boundary Dimensions (mm/inch)					Basic Load Ratings			
	<i>D</i>	<i>B</i> ₂	<i>C</i>	<i>r</i> min.	<i>r</i> ₁ min.	<i>C</i> _r (kN)	<i>C</i> _{0r} (kgf)	<i>C</i> _r	<i>C</i> _{0r}
342.900 13.5000	533.400 21.0000	165.100 6.5000	114.300 4.5000	4.8	1.5	1 810	3 600	185 000	365 000
	533.400 21.0000	174.635 6.8754	123.825 4.8750	4.8	1.5	1 810	3 600	185 000	365 000
	546.100 21.5000	177.800 7.0000	152.400 6.0000	4.8	3.3	1 810	3 600	185 000	365 000
346.075 13.6250	482.600 19.0000	133.350 5.2500	88.900 3.5000	7.0	1.5	1 210	2 840	124 000	289 000
	488.950 19.2500	200.025 7.8750	158.750 6.2500	6.4	1.5	2 130	5 200	218 000	530 000
349.250 13.7500	514.350 20.2500	193.675 7.6250	152.400 6.0000	6.4	1.5	2 270	5 450	232 000	555 000
355	515	194	152.4	6.4	1.5	2 270	5 450	232 000	555 000
355.600 14.0000	444.500 17.5000	136.525 5.3750	111.125 4.3750	3.5	1.5	1 140	3 300	116 000	340 000
	482.600 19.0000	133.350 5.2500	88.900 3.5000	7.0	1.5	1 210	2 840	124 000	289 000
	501.650 19.7500	155.575 6.1250	107.950 4.2500	6.4	1.5	1 360	3 300	139 000	335 000
	514.350 20.2500	193.675 7.6250	152.400 6.0000	6.4	1.5	2 270	5 450	232 000	555 000
360	540	134	120	6	2	1 690	3 300	173 000	335 000
	540	169	134	6	2	2 280	4 800	232 000	490 000
	560	300	240	6	2	4 100	9 500	420 000	970 000
	600	192	171	6	2	2 860	5 750	291 000	585 000
	600	240	192	6	2	3 850	8 000	390 000	815 000
	605	192	171	6	2	2 860	5 750	291 000	585 000
368.300 14.5000	596.900 23.5000	203.200 8.0000	133.350 5.2500	9.7	2.3	2 860	5 750	291 000	585 000

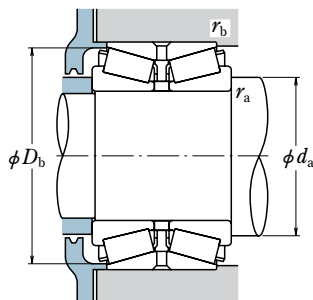

Dynamic Equivalent Load

$$P = XF_r + YF_a$$

$F_a/F_r \leq e$		$F_a/F_r > e$	
X	Y	X	Y
1	Y_3	0.67	Y_2

Static Equivalent Load

$$P_0 = F_r + Y_0 F_a$$

The values of e , Y_2 , Y_3 , and Y_0 are given in the table below.

Bearing Numbers	Abutment and Fillet Dimensions (mm)				Constant e	Axial Load Factors			Mass (kg) approx.
	d_a	D_b	r_a max.	r_b max.		Y_2	Y_3	Y_0	
* EE971354 / 972102D+L	390	510	4.8	1.5	0.33	3.0	2.0	2.0	116
* EE971354 / 972103D+L	390	510	4.8	1.5	0.33	3.0	2.0	2.0	121
* EE971354 / 972151D+L	390	517	4.8	3.3	0.33	3.0	2.0	2.0	141
* EE161363 / 161901D+L	385	465	7.0	1.5	0.50	2.0	1.4	1.3	64.8
* HM262749 / HM262710D+L	386	475	6.4	1.5	0.33	3.0	2.0	2.0	109
* EE333137 / 333203D+L	394	495	6.4	1.5	0.37	2.7	1.8	1.8	130
355KBE5101+L	397	495	6.4	1.5	0.37	2.7	1.8	1.8	126
* L163149 / L163110D+L	381	435	3.5	1.5	0.31	3.3	2.2	2.1	44.7
* EE161400 / 161901D+L	390	465	7.0	1.5	0.50	2.0	1.4	1.3	59.3
* EE231400 / 231976D+L	403	489	6.4	1.5	0.44	2.3	1.5	1.5	85.8
* EE333140 / 333203D+L	397	495	6.4	1.5	0.37	2.7	1.8	1.8	125
360KBE30+L	405	522	5	2	0.39	2.6	1.7	1.7	97.6
360KBE030+L	409	524	5	2	0.39	2.6	1.7	1.7	123
360KBE5601A+L	410	540	4	2	0.28	3.6	2.4	2.4	254
360KBE31+L	420	577	5	2	0.41	2.4	1.6	1.6	214
360KBE031+L	420	577	5	2	0.39	2.6	1.7	1.7	260
360KBE6001+L	420	579	5	2	0.41	2.4	1.6	1.6	220
* EE181453 / 182351D+L	428	570	9.7	2.3	0.41	2.4	1.6	1.6	196

Note * Bearings marked * are inch design.

DOUBLE-ROW TAPERED ROLLER BEARINGS

KBE (TDO) Type, Double Cup, Single Cones

Bore Diameter 371.475 – 400 mm

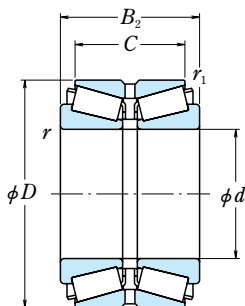

<i>d</i>	Boundary Dimensions (mm/inch)					Basic Load Ratings			
	<i>D</i>	<i>B</i> ₂	<i>C</i>	<i>r</i> min.	<i>r</i> ₁ min.	<i>C</i> _r (kN)	<i>C</i> _{0r}	<i>C</i> _r (kgf)	<i>C</i> _{0r}
371.475 14.6250	501.650 19.7500	155.575 6.1250	107.950 4.2500	6.4	1.5	1 360	3 300	139 000	335 000
	514.350 20.2500	155.575 6.1250	107.950 4.2500	6.4	1.5	1 360	3 300	139 000	335 000
380	560	135	122	6	2	1 830	3 700	186 000	375 000
	560	171	135	6	2	2 480	5 450	253 000	555 000
	620	194	173	6	2	2 560	4 850	261 000	495 000
	620	243	194	6	2	3 950	8 550	405 000	870 000
381.000 15.0000	508.000 20.0000	139.700 5.5000	88.900 3.5000	6.4	1.5	1 250	2 980	127 000	305 000
	546.100 21.5000	222.250 8.7500	177.800 7.0000	6.4	1.5	3 150	8 000	320 000	815 000
384.175 15.1250	546.100 21.5000	222.250 8.7500	177.800 7.0000	6.4	1.5	3 150	8 000	320 000	815 000
385	550	220	180	6	1.5	3 150	8 000	320 000	815 000
390	600	185	130	5	1.5	2 470	5 300	252 000	540 000
	600	310	220	6	1.5	3 800	8 750	390 000	895 000
	600	310	220	6	1.5	4 150	9 500	425 000	970 000
393.700 15.5000	539.750 21.2500	142.875 5.6250	101.600 4.0000	6.4	1.5	1 400	3 300	142 000	335 000
	546.100 21.5000	158.750 6.2500	117.475 4.6250	6.4	1.5	1 400	3 300	142 000	335 000
	560.248 22.0570	146.050 5.7500	104.780 4.1252	6.4	1.5	1 400	3 300	142 000	335 000
396.875 15.6250	539.750 21.2500	142.875 5.6250	101.600 4.0000	6.4	1.5	1 400	3 300	142 000	335 000
	546.100 21.5000	158.750 6.2500	117.475 4.6250	6.4	1.5	1 400	3 300	142 000	335 000
400	540	140	100	6	1	1 400	3 300	142 000	335 000
	600	148	132	6	2	2 080	4 250	212 000	435 000
	600	185	148	6	2	2 710	5 950	277 000	610 000
	650	200	178	6	3	3 300	6 750	340 000	685 000
	650	250	200	6	3	4 200	9 150	430 000	935 000

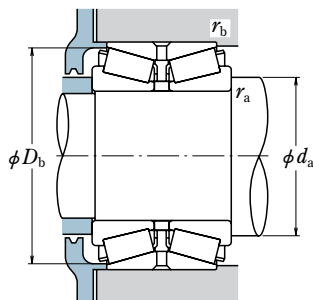

Dynamic Equivalent Load

$$P = XF_r + YF_a$$

$F_a/F_r \leq e$		$F_a/F_r > e$	
X	Y	X	Y
1	Y_3	0.67	Y_2

Static Equivalent Load

$$P_0 = F_r + Y_0 F_a$$

The values of e , Y_2 , Y_3 , and Y_0 are given in the table below.

Bearing Numbers	Abutment and Fillet Dimensions (mm)				Constant e	Axial Load Factors			Mass (kg) approx.
	d_a	D_b	r_a max.	r_b max.		Y_2	Y_3	Y_0	
* EE231462 / 231976D+L	411	489	6.4	1.5	0.44	2.3	1.5	1.5	75.3
* EE231462 / 232026D+L	411	495	6.4	1.5	0.44	2.3	1.5	1.5	83.8
380KBE30+L	424	541	5	2	0.37	2.7	1.8	1.8	110
380KBE030B+L	428	543	5	2	0.37	2.7	1.8	1.8	136
380KBE31+L	437	596	5	2	0.39	2.6	1.7	1.7	206
380KBE031A1+L	443	599	5	2	0.39	2.6	1.7	1.7	276
* EE192150 / 192201D+L	420	495	6.4	1.5	0.53	1.9	1.3	1.2	66.1
* HM266447 / HM266410D+L	428	531	6.4	1.5	0.33	3.0	2.0	2.0	162
* HM266449-N3 / HM266410D+L	429	531	6.4	1.5	0.33	3.0	2.0	2.0	159
385KBE5501+L	429	534	5	1.5	0.33	3.0	2.0	2.0	162
390KBE6002+L	442	575	4	1.5	0.37	2.7	1.8	1.8	178
390KBE6001+L	444	581	4	1	0.35	2.9	1.9	1.9	279
390KBE6003A+L	444	582	4	1	0.34	2.9	2.0	1.9	287
* EE234154 / 234213D+L	438	526	6.4	1.5	0.48	2.1	1.4	1.4	84.7
* EE234154 / 234216D+L	438	529	6.4	1.5	0.48	2.1	1.4	1.4	97
* EE234154 / 234223D+L	438	536	6.4	1.5	0.48	2.1	1.4	1.4	100
* EE234156 / 234213D+L	439	526	6.4	1.5	0.48	2.1	1.4	1.4	82.5
* EE234156 / 234216D+L	439	529	6.4	1.5	0.48	2.1	1.4	1.4	94.6
400KBE5401+L	440	527	5	1	0.48	2.1	1.4	1.4	78.4
400KBE30+L	450	579	5	2	0.37	2.7	1.8	1.8	135
400KBE030B+L	453	581	5	2	0.37	2.7	1.8	1.8	174
400KBE31D+L	458	622	5	2.5	0.39	2.6	1.7	1.7	253
400KBE031B+L	462	625	5	2.5	0.39	2.6	1.7	1.7	309

Note * Bearings marked * are inch design.

DOUBLE-ROW TAPERED ROLLER BEARINGS

KBE (TDO) Type, Double Cup, Single Cones

Bore Diameter 406.400 – 425.450 mm

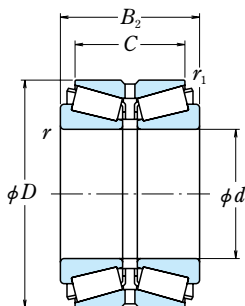

d	Boundary Dimensions (mm/inch)					Basic Load Ratings			
	D	B_2	C	r min.	r_1 min.	(kN)		(kgf)	
						C_r	C_{0r}	C_r	C_{0r}
406.400 16.0000	539.750 21.2500	142.875 5.6250	101.600 4.0000	6.4	1.5	1 400	3 300	142 000	335 000
	546.100 21.5000	158.750 6.2500	117.475 4.6250	6.4	1.5	1 400	3 300	142 000	335 000
	546.100 21.5000	185.738 7.3125	144.462 5.6875	6.4	1.5	2 270	5 950	232 000	605 000
	546.100 21.5000	185.738 7.3125	147.638 5.8125	6.4	1.5	2 270	5 950	232 000	605 000
	574.675 22.6250	157.162 6.1875	106.362 4.1875	6.8	1.5	1 580	3 700	161 000	380 000
	609.524 23.9970	177.800 7.0000	133.350 5.2500	8.0	1.5	2 590	5 600	264 000	570 000
	609.600 24.0000	187.325 7.3750	123.825 4.8750	6.8	1.5	2 520	5 500	257 000	560 000
673.100 26.5000	192.639 7.5842	127.000 5.0000	6.4	1.5	3 000	6 200	305 000	630 000	
409.575 16.1250	574.675 22.6250	157.162 6.1875	106.362 4.1875	6.8	1.5	1 580	3 700	161 000	380 000
411.162 16.1875	609.600 24.0000	187.325 7.3750	123.825 4.8750	6.8	1.5	2 520	5 500	257 000	560 000
415.925 16.3750	590.550 23.2500	244.475 9.6250	193.675 7.6250	6.4	1.5	3 450	8 600	350 000	875 000
420	600	150	134	6	2	2 240	4 750	229 000	485 000
	620	150	134	6	2	2 240	4 750	229 000	485 000
	620	188	150	6	2	2 850	6 450	290 000	655 000
	700	224	200	6	3	3 950	8 200	405 000	840 000
	700	274	200	6	2.5	4 650	9 600	475 000	975 000
	700	280	224	6	3	5 150	11 500	525 000	1 170 000
425.450 16.7500	685.698 26.9960	311.150 12.2500	234.950 9.2500	12.7	3.3	5 200	11 400	530 000	1 160 000

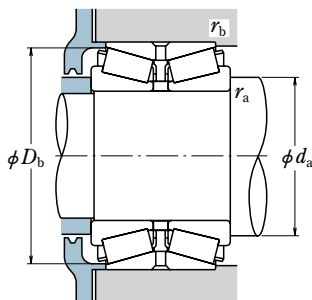

Dynamic Equivalent Load

$$P = X F_r + Y F_a$$

$F_a/F_r \leq e$		$F_a/F_r > e$	
X	Y	X	Y
1	Y_3	0.67	Y_2

Static Equivalent Load

$$P_0 = F_r + Y_0 F_a$$

The values of e , Y_2 , Y_3 , and Y_0 are given in the table below.

Bearing Numbers	Abutment and Fillet Dimensions (mm)				Constant e	Axial Load Factors			Mass (kg) approx.
	d_a	D_b	r_a max.	r_b max.		Y_2	Y_3	Y_0	
* EE234160 / 234213D+L	444	526	6.4	1.5	0.48	2.1	1.4	1.4	82.6
* EE234160 / 234216D+L	444	529	6.4	1.5	0.48	2.1	1.4	1.4	94.2
* M667944 / M667910D+L	449	536	6.4	1.5	0.42	2.4	1.6	1.6	113
* M667944 / M667911D+L	449	537	6.4	1.5	0.42	2.4	1.6	1.6	114
* EE285160 / 285228D+L	453	552	6.8	1.5	0.50	2.0	1.4	1.3	111
* EE736160-N1 / 736239D+L	459	585	8.0	1.5	0.35	2.9	1.9	1.9	163
* EE911600 / 912401D+L	459	586	6.8	1.5	0.38	2.6	1.8	1.7	172
* EE571602 / 572651D+L	479	646	6.4	1.5	0.40	2.5	1.7	1.7	251
* EE285162 / 285228D+L	455	552	6.8	1.5	0.50	2.0	1.4	1.3	109
* EE911618 / 912401D+L	461	586	6.8	1.5	0.38	2.6	1.8	1.7	167
* M268749 / M268710D+L	465	576	6.4	1.5	0.33	3.0	2.0	2.0	201
420KE6001A+L	467	588	5	2	0.39	2.6	1.7	1.7	131
420KE30+L	467	598	5	2	0.39	2.6	1.7	1.7	151
420KE030+L	471	600	5	2	0.39	2.6	1.7	1.7	184
420KE31C+L	486	670	5	2.5	0.39	2.6	1.7	1.7	342
420KE7001+L	486	669	5	2	0.32	3.2	2.1	2.1	390
420KE031B1+L	493	673	5	2.5	0.39	2.6	1.7	1.7	422
* EE328167-N1 / 328268D+L	497	661	12.7	3.3	0.40	2.5	1.7	1.7	410

Note * Bearings marked * are inch design.

DOUBLE-ROW TAPERED ROLLER BEARINGS

KBE (TDO) Type, Double Cup, Single Cones

Bore Diameter 431.800 – 479.425 mm

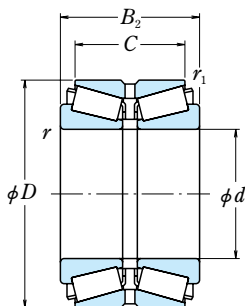

<i>d</i>	Boundary Dimensions (mm/inch)					Basic Load Ratings			
	<i>D</i>	<i>B</i> ₂	<i>C</i>	<i>r</i> min.	<i>r</i> ₁ min.	(kN)		(kgf)	
						<i>C</i> _r	<i>C</i> _{0r}	<i>C</i> _r	<i>C</i> _{0r}
431.800 17.0000	571.500 22.5000	155.575 6.1250	111.125 4.3750	3.3	1.5	1 840	4 700	188 000	480 000
	673.100 26.5000	192.639 7.5842	127.000 5.0000	6.4	1.5	3 000	6 200	305 000	630 000
	673.100 26.5000	192.639 7.5842	152.400 6.0000	6.4	1.5	3 000	6 200	305 000	630 000
440	650	157	140	6	3	2 540	5 600	259 000	575 000
	650	196	157	6	3	3 100	7 300	315 000	745 000
	655	196	157	6	3	3 100	7 300	315 000	745 000
	720	226	201	6	3	4 100	8 500	420 000	870 000
	720	283	226	6	3	5 300	11 700	540 000	1 200 000
441.325 17.3750	660.400 26.0000	195.262 7.6875	138.112 5.4375	10.4	1.5	2 650	5 550	270 000	570 000
447.675 17.6250	635.000 25.0000	257.175 10.1250	206.375 8.1250	6.4	1.5	3 250	8 650	330 000	885 000
457	573	170	135	6	2.5	1 760	5 250	179 000	535 000
457.200 18.0000	596.900 23.5000	165.100 6.5000	120.650 4.7500	9.5	1.5	1 790	4 750	182 000	480 000
	660.400 26.0000	195.262 7.6875	138.112 5.4375	10.4	1.5	2 650	5 550	270 000	570 000
	730.148 28.7460	254.000 10.0000	177.800 7.0000	9.7	1.5	3 900	8 350	400 000	850 000
460	620	169	131	5	1.5	2 260	5 450	231 000	560 000
	640	200	160	6	2.5	2 350	6 350	240 000	650 000
	680	163	145	6	3	2 680	5 900	273 000	605 000
	680	204	163	6	3	3 400	7 950	345 000	810 000
	760	240	214	7.5	4	3 650	7 100	370 000	725 000
	760	300	240	7.5	4	5 850	13 100	595 000	1 330 000
479.425 18.8750	679.450 26.7500	276.225 10.8750	222.250 8.7500	6.4	1.5	4 800	12 800	490 000	1 300 000

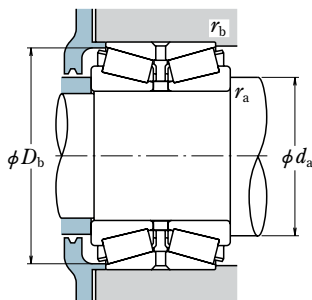

Dynamic Equivalent Load

$$P = XF_r + YF_a$$

$F_a/F_r \leq e$		$F_a/F_r > e$	
X	Y	X	Y
1	Y_3	0.67	Y_2

Static Equivalent Load

$$P_0 = F_r + Y_0 F_a$$

The values of e , Y_2 , Y_3 , and Y_0 are given in the table below.

Bearing Numbers	Abutment and Fillet Dimensions (mm)				Constant e	Axial Load Factors			Mass (kg) approx.
	d_a	D_b	r_a max.	r_b max.		Y_2	Y_3	Y_0	
* LM869448 / LM869410D+L	471	560	3.3	1.5	0.55	1.8	1.2	1.2	98.4
* EE571703-N2 / 572651D+L	491	646	6.4	1.5	0.40	2.5	1.7	1.7	225
* EE571703 / 572653D+L	491	649	6.4	1.5	0.40	2.5	1.7	1.7	235
440KBE30A+L	493	628	5	2.5	0.37	2.7	1.8	1.8	175
440KBE030A+L	497	630	5	2.5	0.37	2.7	1.8	1.8	214
440KBE6501+L	497	633	5	2.5	0.37	2.7	1.8	1.8	220
440KBE31A+L	505	691	5	2.5	0.39	2.6	1.7	1.7	355
440KBE031A1+L	511	694	5	2.5	0.39	2.6	1.7	1.7	438
* EE737173 / 737261D+L	499	636	10.4	1.5	0.37	2.7	1.8	1.8	198
* M270749 / M270710D+L	502	617	6.4	1.5	0.33	3.0	2.0	2.0	243
457KBE5701+L	493	561	5	2	0.40	2.5	1.7	1.7	91.8
* EE244180 / 244236D+L	500	581	9.5	1.5	0.40	2.5	1.7	1.6	106
* EE737181 / 737261D+L	507	636	10.4	1.5	0.37	2.7	1.8	1.8	182
* EE671801 / 672875D+L	527	699	9.7	1.5	0.39	2.6	1.7	1.7	368
460KBE6201+L	501	605	4	1.5	0.40	2.5	1.7	1.6	132
460KBE6401+L	517	627	5	2	0.47	2.1	1.4	1.4	185
460KBE30B+L	515	657	5	2.5	0.40	2.5	1.7	1.6	199
460KBE030A2+L	518	659	5	2.5	0.40	2.5	1.7	1.6	244
460KBE31A+L	532	728	6	3	0.39	2.6	1.7	1.7	421
460KBE031A1+L	538	732	6	3	0.39	2.6	1.7	1.7	522
* M272749-N / M272710D+L	535	663	6.4	1.5	0.34	3.0	2.0	1.9	309

Note * Bearings marked * are inch design.

DOUBLE-ROW TAPERED ROLLER BEARINGS

KBE (TDO) Type, Double Cup, Single Cones

Bore Diameter 480 – 508.000 mm

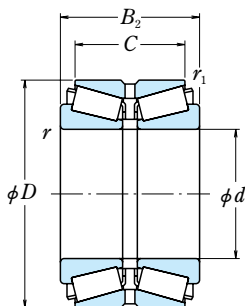

<i>d</i>	Boundary Dimensions (mm/inch)					Basic Load Ratings			
	<i>D</i>	<i>B</i> ₂	<i>C</i>	<i>r</i> min.	<i>r</i> ₁ min.	(kN)		(kgf)	
						<i>C</i> _r	<i>C</i> _{0r}	<i>C</i> _r	<i>C</i> _{0r}
480	615	120	94	3	1	1 340	3 400	136 000	345 000
	700	165	147	6	3	2 800	6 000	285 000	615 000
	700	206	165	6	3	3 550	8 100	360 000	825 000
	790	248	221	7.5	4	4 800	10 000	490 000	1 020 000
	790	310	248	7.5	4	6 300	14 100	640 000	1 440 000
482.600 19.0000	615.950	184.150	146.050	6.4	1.5	2 380	6 900	243 000	705 000
	24.2500	7.2500	5.7500						
	634.873	177.800	142.875	6.4	1.5	2 290	6 600	233 000	675 000
	24.9950	7.0000	5.6250						
488.671	660.400	206.375	158.750	6.4	1.5	2 920	7 550	298 000	770 000
19.2390	26.0000	8.1250	6.2500						
488.950 19.2500	634.873	180.975	136.525	6.4	1.5	2 350	6 350	240 000	650 000
	24.9950	7.1250	5.3750						
	660.400	206.375	158.750	6.4	1.5	2 920	7 550	298 000	770 000
	26.0000	8.1250	6.2500						
489.026 19.2530	634.873	177.800	142.875	6.4	1.5	2 290	6 600	233 000	675 000
	24.9950	7.0000	5.6250						
498.475 19.6250	634.873	177.800	142.875	6.4	1.5	2 290	6 600	233 000	675 000
	24.9950	7.0000	5.6250						
500	720	167	149	6	3	2 730	6 100	278 000	620 000
	720	209	167	6	3	3 600	8 700	365 000	885 000
	830	264	235	7.5	4	5 400	11 500	550 000	1 170 000
	830	330	264	7.5	4	7 000	16 000	715 000	1 630 000
	910	360	260	7.5	4	7 300	14 900	745 000	1 510 000
505	660	235	180	6	1.5	3 250	9 000	330 000	920 000
505.968 19.9200	736.600	186.502	114.300	6.4	1.5	2 780	6 800	284 000	690 000
	29.0000	7.3426	4.5000						
506	636	187	147	7	2	2 360	7 000	241 000	715 000
508.000 20.0000	736.600	186.502	114.300	6.4	1.5	2 780	6 800	284 000	690 000
	29.0000	7.3426	4.5000						
	838.200	304.800	222.250	9.5	3.3	6 200	14 100	635 000	1 440 000
	33.0000	12.0000	8.7500						

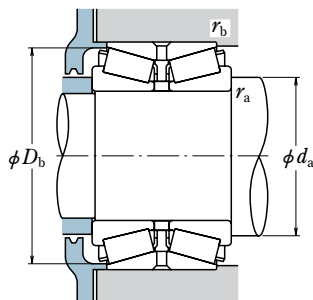

Dynamic Equivalent Load

$$P = X F_r + Y F_a$$

$F_a/F_r \leq e$		$F_a/F_r > e$	
X	Y	X	Y
1	Y_3	0.67	Y_2

Static Equivalent Load

$$P_0 = F_r + Y_0 F_a$$

The values of e , Y_2 , Y_3 , and Y_0 are given in the table below.

Bearing Numbers	Abutment and Fillet Dimensions (mm)				Constant e	Axial Load Factors			Mass (kg) approx.
	d_a	D_b	r_a max.	r_b max.		Y_2	Y_3	Y_0	
480KBE6101+L	514	600	2.5	1	0.35	2.9	1.9	1.9	80.5
480KBE30A1+L	534	678	5	2.5	0.39	2.6	1.7	1.7	207
480KBE030A+L	536	678	5	2.5	0.39	2.6	1.7	1.7	253
480KBE31+L	553	757	6	3	0.39	2.6	1.7	1.7	472
480KBE031C+L	559	760	6	3	0.39	2.6	1.7	1.7	579
* LM272249 / LM272210D+L	522	604	6.4	1.5	0.37	2.7	1.8	1.8	126
* EE243190 / 243251D+L	530	622	6.4	1.5	0.34	2.9	2.0	1.9	144
* EE640191 / 640261D+L	535	643	6.4	1.5	0.31	3.3	2.2	2.1	185
* LM772748 / LM772710D+L	532	623	6.4	1.5	0.47	2.1	1.4	1.4	134
* EE640192 / 640261D+L	535	643	6.4	1.5	0.31	3.3	2.2	2.1	185
* EE243192 / 243251D+L	533	622	6.4	1.5	0.34	2.9	2.0	1.9	137
* EE243196 / 243251D+L	538	622	6.4	1.5	0.34	2.9	2.0	1.9	127
500KBE30H+L	552	696	5	2.5	0.39	2.6	1.7	1.7	216
500KBE030B+L	557	698	5	2.5	0.39	2.6	1.7	1.7	266
500KBE31A+L	577	793	6	3	0.39	2.6	1.7	1.7	563
500KBE031+L	583	797	6	3	0.39	2.6	1.7	1.7	692
500KBE9101+L	599	868	6	3	0.55	1.8	1.2	1.2	929
505KBE6601+L	546	645	5	1.5	0.31	3.3	2.2	2.1	193
* EE981992 / 982901D+L	571	712	6.4	1.5	0.48	2.1	1.4	1.4	242
506KBE6301+L	546	625	7	2	0.35	2.8	1.9	1.9	128
* EE982003 / 982901D+L	572	712	6.4	1.5	0.48	2.1	1.4	1.4	240
* EE426200 / 426331D+L	595	804	9.5	3.3	0.48	2.1	1.4	1.4	638

Note * Bearings marked * are inch design.

DOUBLE-ROW TAPERED ROLLER BEARINGS

KBE (TDO) Type, Double Cup, Single Cones

Bore Diameter 515 – 565.150 mm

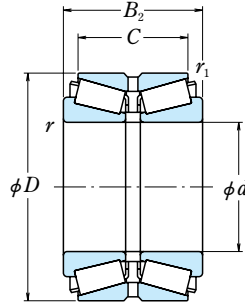

<i>d</i>	Boundary Dimensions (mm/inch)					Basic Load Ratings			
	<i>D</i>	<i>B</i> ₂	<i>C</i>	<i>r</i> min.	<i>r</i> ₁ min.	(kN)		(kgf)	
						<i>C</i> _r	<i>C</i> _{0r}	<i>C</i> _r	<i>C</i> _{0r}
515	720	180	140	6	3	2 730	6 100	278 000	620 000
520.700 20.5000	736.600 29.0000	186.502 7.3426	114.300 4.5000	6.4	1.5	2 780	6 800	284 000	690 000
530	780	185	163	6	3	3 600	8 200	365 000	835 000
	780	231	185	6	3	4 450	10 700	450 000	1 100 000
	870	272	239	7.5	4	5 850	12 500	595 000	1 270 000
	870	340	272	7.5	4	7 300	16 600	745 000	1 700 000
533.400 21.0000	784.225 30.8750	190.500 7.5000	120.650 4.7500	6.4	1.5	3 000	7 000	305 000	710 000
	812.800 32.0000	269.875 10.6250	187.325 7.3750	9.7	3.3	4 950	11 300	505 000	1 150 000
546.100 21.5000	736.600 29.0000	165.100 6.5000	114.300 4.5000	6.4	3.3	2 190	5 200	223 000	530 000
558.800 22.0000	736.600 29.0000	165.100 6.5000	114.300 4.5000	6.4	3.3	2 190	5 200	223 000	530 000
	736.600 29.0000	187.328 7.3751	138.112 5.4375	6.4	1.5	3 000	7 800	305 000	795 000
	736.600 29.0000	225.425 8.8750	160.000 6.2992	6.4	1.5	3 350	9 200	345 000	935 000
	736.600 29.0000	225.425 8.8750	177.800 7.0000	6.4	1.5	3 950	11 200	400 000	1 150 000
	742.950 29.2500	187.328 7.3751	138.112 5.4375	6.4	1.5	3 000	7 800	305 000	795 000
560	735	225	180	6.4	1.5	3 950	11 200	400 000	1 150 000
	820	195	173	6	3	3 700	8 650	380 000	880 000
	820	244	195	6	3	4 900	12 400	500 000	1 260 000
	920	280	246	7.5	4	6 300	13 400	640 000	1 370 000
	920	350	280	7.5	4	8 100	18 600	825 000	1 890 000
560.000 22.0472	740.000 29.1339	190.000 7.4803	140.000 5.5118	6.4	1.5	3 000	7 800	305 000	795 000
565.150 22.2500	863.600 34.0000	317.500 12.5000	228.600 9.0000	8.0	3.3	6 550	15 200	665 000	1 550 000

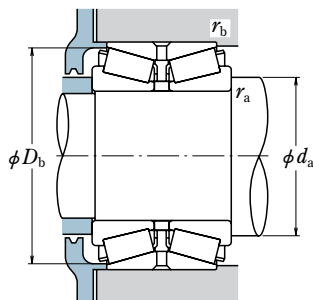

Dynamic Equivalent Load

$$P = X F_r + Y F_a$$

$F_a/F_r \leq e$		$F_a/F_r > e$	
X	Y	X	Y
1	Y_3	0.67	Y_2

Static Equivalent Load

$$P_0 = F_r + Y_0 F_a$$

The values of e , Y_2 , Y_3 , and Y_0 are given in the table below.

Bearing Numbers	Abutment and Fillet Dimensions (mm)				Constant e	Axial Load Factors			Mass (kg) approx.
	d_a	D_b	r_a max.	r_b max.		Y_2	Y_3	Y_0	
515KBE7201+L	560	693	5	2.5	0.39	2.6	1.7	1.7	204
* EE982051 / 982901D+L	579	712	6.4	1.5	0.48	2.1	1.4	1.4	225
530KBE30A1+L	589	752	5	2.5	0.37	2.7	1.8	1.8	295
530KBE030+L	593	754	5	2.5	0.37	2.7	1.8	1.8	362
530KBE31+L	610	834	6	3	0.39	2.6	1.7	1.7	620
530KBE031A+L	614	836	6	3	0.39	2.6	1.7	1.7	771
* EE522102 / 523088D+L	596	752	6.4	1.5	0.48	2.1	1.4	1.4	276
* EE626210 / 626321D+L	607	783	9.7	3.3	0.44	2.3	1.5	1.5	465
* EE542215 / 542291D+L	598	715	6.4	3.3	0.51	2.0	1.3	1.3	168
* EE542220 / 542291D+L	604	715	6.4	3.3	0.51	2.0	1.3	1.3	154
* EE843220 / 843291D+L	606	718	6.4	1.5	0.34	2.9	2.0	1.9	195
* 558KBE7351+L	606	718	6.4	1.5	0.35	2.9	1.9	1.9	234
* LM377449-N4 / LM377410D+L	607	720	6.4	1.5	0.35	2.9	1.9	1.9	247
* EE843220 / 843292D+L	606	721	6.4	1.5	0.34	2.9	2.0	1.9	203
560KBE7301C+L	608	719	6.4	1.5	0.35	2.9	1.9	1.9	244
560KBE30A1+L	622	790	5	2.5	0.39	2.6	1.7	1.7	342
560KBE030J+L	627	793	5	2.5	0.39	2.6	1.7	1.7	423
560KBE31+L	643	881	6	3	0.39	2.6	1.7	1.7	724
560KBE031D+L	649	885	6	3	0.39	2.6	1.7	1.7	891
* 560KBE7451+L	606	720	6.4	1.5	0.34	2.9	2.0	1.9	200
* EE929225-N1 / 929341D+L	638	832	8.0	3.3	0.34	2.9	2.0	1.9	613

Note * Bearings marked * are inch design.

DOUBLE-ROW TAPERED ROLLER BEARINGS

KBE (TDO) Type, Double Cup, Single Cones

Bore Diameter 570 – 670 mm

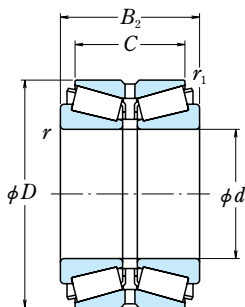

<i>d</i>	Boundary Dimensions (mm/inch)					Basic Load Ratings			
	<i>D</i>	<i>B</i> ₂	<i>C</i>	<i>r</i> min.	<i>r</i> ₁ min.	(kN)		(kgf)	
						<i>C</i> _r	<i>C</i> _{0r}	<i>C</i> _r	<i>C</i> _{0r}
570	815	345	265	6	3	6 850	18 600	700 000	1 900 000
580	800	300	235	6	3	5 900	15 600	600 000	1 590 000
600	870	200	176	6	3	4 150	9 650	420 000	985 000
	870	250	200	6	3	5 350	13 400	545 000	1 370 000
	980	300	264	7.5	4	7 350	16 300	750 000	1 660 000
	980	388	300	7.5	4	9 700	23 200	990 000	2 370 000
602.945 23.7380	787.400 31.0000	206.375 8.1250	158.750 6.2500	6.4	1.5	3 450	9 600	350 000	980 000
	793.750 31.2500	206.375 8.1250	158.750 6.2500	6.4	1.5	3 450	9 600	350 000	980 000
607.720 23.9260	787.400 31.0000	206.375 8.1250	158.750 6.2500	6.4	1.5	3 450	9 600	350 000	980 000
609.600 24.0000	717.550 28.2500	127.000 5.0000	95.250 3.7500	6.4	1.5	1 530	4 600	156 000	470 000
	787.400 31.0000	206.375 8.1250	158.750 6.2500	6.4	1.5	3 450	9 600	350 000	980 000
	793.750 31.2500	206.375 8.1250	158.750 6.2500	6.4	1.5	3 450	9 600	350 000	980 000
	812.800 32.0000	190.500 7.5000	146.050 5.7500	6.4	3.3	2 860	7 850	292 000	800 000
620	825	190	145	6	1.5	2 860	7 850	292 000	800 000
630	920	212	186	7.5	4	4 650	11 100	475 000	1 130 000
	920	265	212	7.5	4	5 850	15 000	600 000	1 530 000
	1 030	315	277	7.5	4	8 050	18 000	820 000	1 830 000
	1 030	389	315	7.5	4	10 100	23 000	1 030 000	2 340 000
650	820	205	160	6	1	3 450	10 400	350 000	1 060 000
	920	210	185	5	2	4 650	11 100	475 000	1 130 000
660	830	180	140	6	2.5	3 050	8 700	310 000	885 000
670	880	185	130	5	2	3 300	8 550	340 000	870 000
	980	230	202	7.5	4	5 300	12 300	540 000	1 260 000
	980	288	230	7.5	4	6 900	16 200	700 000	1 650 000
	1 090	336	295	7.5	4	8 750	19 600	890 000	2 000 000
	1 090	392	336	7.5	4	10 300	24 300	1 050 000	2 480 000

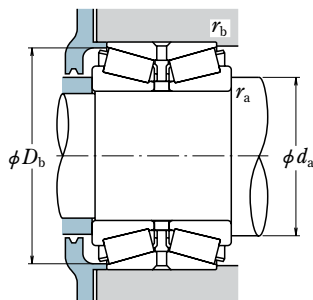

Dynamic Equivalent Load

$$P = XF_r + YF_a$$

$F_a/F_r \leq e$		$F_a/F_r > e$	
X	Y	X	Y
1	Y_3	0.67	Y_2

Static Equivalent Load

$$P_0 = F_r + Y_0 F_a$$

The values of e , Y_2 , Y_3 , and Y_0 are given in the table below.

Bearing Numbers	Abutment and Fillet Dimensions (mm)				Constant e	Axial Load Factors			Mass (kg) approx.
	d_a	D_b	r_a max.	r_b max.		Y_2	Y_3	Y_0	
570KBE8101+L	633	791	5	2.5	0.33	3.0	2.0	2.0	551
580KBE8003A+L	635	781	5	2.5	0.33	3.1	2.1	2.0	430
600KBE30B+L	666	841	5	2.5	0.39	2.6	1.7	1.7	387
600KBE030D+L	669	844	5	2.5	0.39	2.6	1.7	1.7	487
600KBE31C+L	688	938	6	3	0.37	2.7	1.8	1.8	882
600KBE031A1+L	696	943	6	3	0.37	2.7	1.8	1.8	1 120
* EE649237 / 649311D+L	655	771	6.4	1.5	0.37	2.7	1.8	1.8	244
* EE649237 / 649313D+L	655	774	6.4	1.5	0.37	2.7	1.8	1.8	253
* EE649239 / 649311D+L	658	771	6.4	1.5	0.37	2.7	1.8	1.8	237
* LL579749 / LL579710D+L	642	708	6.4	1.5	0.40	2.5	1.7	1.6	81.7
* EE649240-N1 / 649311D+L	659	771	6.4	1.5	0.37	2.7	1.8	1.8	234
* EE649240 / 649313D+L	659	774	6.4	1.5	0.37	2.7	1.8	1.8	243
* EE743240 / 743321D+L	664	785	6.4	3.3	0.33	3.1	2.1	2.0	241
620KBE8201+L	668	793	5	1.5	0.33	3.1	2.1	2.0	247
630KBE30A+L	702	887	6	3	0.36	2.8	1.9	1.8	464
630KBE030B+L	705	889	6	3	0.36	2.8	1.9	1.8	574
630KBE31+L	730	962	6	3	0.37	2.7	1.8	1.8	1 000
630KBE031B+L	725	992	6	3	0.37	2.7	1.8	1.8	1 230
650KBE8201+L	697	804	5	1	0.35	2.8	1.9	1.9	245
650KBE9201A+L	709	889	4	2	0.36	2.8	1.9	1.8	428
660KBE8301A+L	705	813	5	2	0.39	2.6	1.7	1.7	213
670KBE8801+L	721	857	4	2	0.45	2.2	1.5	1.5	278
670KBE30B+L	743	946	6	3	0.37	2.7	1.8	1.8	571
670KBE030B+L	742	948	6	3	0.37	2.7	1.8	1.8	706
670KBE31A1+L	760	1 037	6	3	0.37	2.7	1.8	1.8	1 210
670KBE031B+L	764	1 042	6	3	0.37	2.7	1.8	1.8	1 390

Note * Bearings marked * are inch design.

DOUBLE-ROW TAPERED ROLLER BEARINGS

KBE (TDO) Type, Double Cup, Single Cones

Bore Diameter 673.100 – 870 mm

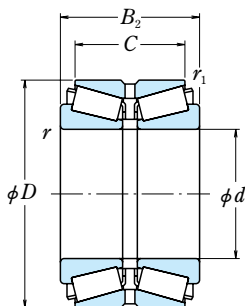

<i>d</i>	Boundary Dimensions (mm/inch)					Basic Load Ratings			
	<i>D</i>	<i>B</i> ₂	<i>C</i>	<i>r</i> min.	<i>r</i> ₁ min.	(kN)		(kgf)	
						<i>C</i> _r	<i>C</i> _{0r}	<i>C</i> _r	<i>C</i> _{0r}
673.100 26.5000	793.750 31.2500	133.350 5.2500	98.426 3.8750	6.4	1.5	1 750	5 850	178 000	595 000
685.800 27.0000	876.300 34.5000	200.025 7.8750	152.400 6.0000	6.4	1.5	3 700	11 100	375 000	1 130 000
700	980 1 030	350 380	270 310	7.5 7.5	4 4	8 200 7 850	22 500 19 700	835 000 800 000	2 300 000 2 010 000
710	950 1 030 1 030 1 150	238.5 236 295 393	175 208 236 345	6 7.5 7.5 9.5	2.5 4 4 5	4 600 5 750 7 100 10 700	11 400 14 000 17 200 25 000	470 000 585 000 725 000 1 100 000	1 160 000 1 420 000 1 760 000 2 550 000
711.200 28.0000	914.400 36.0000	190.500 7.5000	139.700 5.5000	6.4	1.5	3 200	9 650	325 000	985 000
723.900 28.5000	914.400 36.0000	187.325 7.3750	139.700 5.5000	3.3	1.5	3 200	9 650	325 000	985 000
740	1 110	340	270	7.5	4	9 200	22 100	940 000	2 250 000
750	1 090 1 090 1 220 1 220	250 313 365 395	220 250 321 365	7.5 7.5 9.5 9.5	4 4 5 5	6 450 8 000 10 600 12 000	15 300 20 000 24 000 28 200	655 000 815 000 1 080 000 1 230 000	1 560 000 2 040 000 2 450 000 2 880 000
762.000 30.0000	965.200 38.0000	187.325 7.3750	133.350 5.2500	6.4	1.5	3 600	10 400	365 000	1 060 000
774.700 30.5000	965.200 38.0000	187.325 7.3750	133.350 5.2500	6.4	1.5	3 600	10 400	365 000	1 060 000
800	1 150 1 150	258 323	227 258	7.5 7.5	4 4	6 550 8 500	15 700 22 700	670 000 865 000	1 600 000 2 310 000
812.800 32.0000	1 016.000 40.0000	190.500 7.5000	146.050 5.7500	6.4	3.5	4 000	12 200	410 000	1 250 000
	1 066.800 42.0000	190.500 7.5000	146.050 5.7500	6.4	3.3	4 000	12 200	410 000	1 250 000
850	1 220 1 220	272 340	239 272	7.5 7.5	4 4	7 450 9 850	18 800 25 000	760 000 1 010 000	1 920 000 2 550 000
870	1 120	210	155	6	2.5	4 800	13 100	485 000	1 340 000

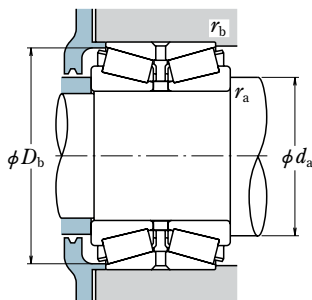

Dynamic Equivalent Load

$$P = X F_r + Y F_a$$

$F_a/F_r \leq e$		$F_a/F_r > e$	
X	Y	X	Y
1	Y_3	0.67	Y_2

Static Equivalent Load

$$P_0 = F_r + Y_0 F_a$$

The values of e , Y_2 , Y_3 , and Y_0 are given in the table below.

Bearing Numbers	Abutment and Fillet Dimensions (mm)				Constant e	Axial Load Factors			Mass (kg) approx.
	d_a	D_b	r_a max.	r_b max.		Y_2	Y_3	Y_0	
* 673KBE7951+L	710	781	6.4	1.5	0.36	2.8	1.9	1.8	108
* EE655270 / 655346D+L	737	857	6.4	1.5	0.42	2.4	1.6	1.6	282
700KBE9801A+L	772	953	6	3	0.33	3.0	2.0	2.0	782
700KBE1005WA+L	784	998	6	3	0.35	2.8	1.9	1.9	1 040
710KBE9502+L	766	926	5	2	0.46	2.2	1.5	1.4	421
710KBE30D+L	788	995	6	3	0.36	2.8	1.9	1.8	642
710KBE030C+L	787	999	6	3	0.39	2.6	1.7	1.7	774
710KBE031+L	812	1 103	8	4	0.37	2.7	1.8	1.8	1 550
* EE755280 / 755361D+L	767	891	6.4	1.5	0.38	2.6	1.8	1.7	298
* EE755285-N1 / 755361D+L	770	891	3.3	1.5	0.38	2.6	1.8	1.7	274
740KBE1101A+L	827	1 072	6	3	0.33	3.0	2.0	2.0	1 100
750KBE30+L	835	1 030	6	3	0.37	2.7	1.8	1.8	749
750KBE030+L	833	1 055	6	3	0.37	2.7	1.8	1.8	931
750KBE31+L	870	1 140	8	4	0.37	2.7	1.8	1.8	1 620
750KBE031+L	870	1 155	8	4	0.37	2.7	1.8	1.8	1 750
* EE752300 / 752381D+L	815	943	6.4	1.5	0.40	2.5	1.7	1.7	303
* EE752305 / 752381D+L	822	943	6.4	1.5	0.40	2.5	1.7	1.7	281
800KBE30C+L	881	1 113	6	3	0.39	2.6	1.7	1.7	843
800KBE030B+L	887	1 113	6	3	0.37	2.7	1.8	1.8	1 050
* EE762320 / 762401D+L	867	994	6.4	3.5	0.42	2.4	1.6	1.6	338
* EE762320 / 762420XD+L	867	1 019	6.4	3.3	0.42	2.4	1.6	1.6	437
850KBE30+L	945	1 155	6	3	0.37	2.7	1.8	1.8	988
850KBE030+L	937	1 183	6	3	0.37	2.7	1.8	1.8	1 240
870KBE1101+L	929	1 092	5	2	0.40	2.5	1.7	1.6	484

Note * Bearings marked * are inch design.

DOUBLE-ROW TAPERED ROLLER BEARINGS

KBE (TDO) Type, Double Cup, Single Cones

Bore Diameter 880 – 2 000 mm

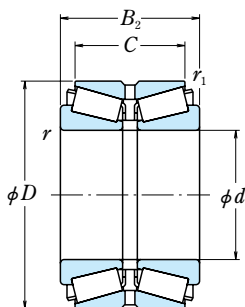

d	Boundary Dimensions (mm/inch)					Basic Load Ratings			
	D	B_2	C	r min.	r_1 min.	(kN)		(kgf)	
						C_r	C_{0r}	C_r	C_{0r}
880	1 080	200	140	6	2.5	4 100	12 900	415 000	1 320 000
900	1 280	280	246	7.5	4	8 150	20 600	830 000	2 100 000
	1 280	350	280	7.5	4	10 100	26 300	1 030 000	2 680 000
914.400	1 066.800	139.700	101.600	6.4	3.3	2 460	8 350	251 000	850 000
	36.0000	42.0000	5.5000	4.0000					
950	1 280	280	246	7.5	4	7 600	19 800	775 000	2 020 000
	1 360	300	264	7.5	4	9 250	23 700	940 000	2 420 000
	1 360	375	300	7.5	4	11 800	32 500	1 210 000	3 300 000
977.900	1 130.300	139.700	101.600	6.4	3.3	2 510	8 750	256 000	890 000
	38.5000	44.5000	5.5000	4.0000					
1 000	1 180	240	190	6	1.5	5 100	19 700	520 000	2 010 000
1 050	1 390	300	215	7.5	4	8 550	24 300	875 000	2 480 000
	1 390	350	280	7.5	4	10 100	29 600	1 030 000	3 000 000
1 120	1 360	250	180	7.5	4	6 050	20 700	620 000	2 110 000
1 150	1 420	250	200	7.5	4	6 100	19 900	625 000	2 030 000
1 270.000	1 435.100	146.050	101.600	6.4	3.3	2 800	11 100	286 000	1 130 000
	50.0000	56.5000	5.7500	4.0000					
1 370	1 605	210	150	7.5	4	5 600	20 300	570 000	2 070 000
1 400	1 850	360	260	9.5	5	12 300	36 000	1 250 000	3 650 000
1 562.100	1 806.575	279.400	196.840	9.7	4.8	7 400	31 500	755 000	3 200 000
	61.5000	71.1250	11.0000	7.7496					
2 000	2 360	200	145	9.5	5	6 250	25 100	635 000	2 560 000

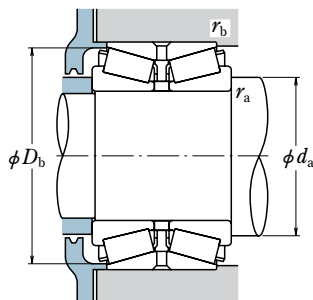

Dynamic Equivalent Load

$$P = XF_r + YF_a$$

$F_a/F_r \leq e$		$F_a/F_r > e$	
X	Y	X	Y
1	Y_3	0.67	Y_2

Static Equivalent Load

$$P_0 = F_r + Y_0 F_a$$

The values of e , Y_2 , Y_3 , and Y_0 are given in the table below.

Bearing Numbers	Abutment and Fillet Dimensions (mm)				Constant e	Axial Load Factors			Mass (kg) approx.
	d_a	D_b	r_a max.	r_b max.		Y_2	Y_3	Y_0	
880KBE1001+L	935	1 061	5	2	0.46	2.2	1.5	1.4	379
900KBE30+L	995	1 210	6	3	0.37	2.7	1.8	1.8	1 110
900KBE030A+L	989	1 240	6	3	0.39	2.6	1.7	1.7	1 350
* LL686947 / LL686910D+L	955	1 048	6.4	3.3	0.41	2.5	1.7	1.6	198
950KBE1201A+L	1 028	1 250	6	3	0.40	2.5	1.7	1.6	971
950KBE30+L	1 055	1 290	6	3	0.37	2.7	1.8	1.8	1 360
950KBE030+L	1 055	1 300	6	3	0.37	2.7	1.8	1.8	1 700
* LL687949 / LL687910D+L	1 019	1 112	6.4	3.3	0.43	2.3	1.6	1.5	210
1000KBE1101+L	1 047	1 160	5	1.5	0.32	3.2	2.1	2.1	451
1050KBE1301+L	1 132	1 352	6	3	0.37	2.7	1.8	1.8	1 140
1050KBE1302A+L	1 134	1 357	6	3	0.35	2.9	1.9	1.9	1 360
1120KBE1301+L	1 185	1 335	6	3	0.49	2.0	1.4	1.3	718
1150KBE1401+L	1 223	1 394	6	3	0.47	2.1	1.4	1.4	808
* LL889049 / LL889010D+L	1 315	1 413	6.4	3.3	0.57	1.8	1.2	1.2	303
1370KBE1601+L	1 430	1 575	6	3	0.40	2.5	1.7	1.6	688
1400KBE1801A+L	1 509	1 800	8	4	0.52	1.9	1.3	1.3	2 410
* EE299615 / 299711D+L	1 632	1 777	9.7	4.8	0.48	2.1	1.4	1.4	1 110
2000KBE2301+L	2 090	2 299	8	4	0.36	2.8	1.9	1.9	1 500

Note * Bearings marked * are inch design.

DOUBLE-ROW TAPERED ROLLER BEARINGS

KDE (TDO) Type, Double Cup, Single Cones, Steep Angle

Bore Diameter 100 – 130 mm

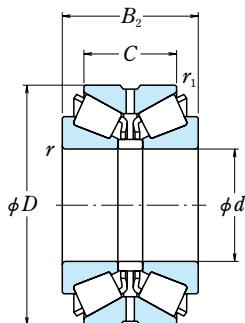

d	Boundary Dimensions (mm/inch)					Basic Load Ratings			
	D	B_2	C	r min.	r_1 min.	C_r (kN)	C_{0r}	C_r (kgf)	C_{0r}
100	180	80	54	3	1	330	500	33 500	51 000
	200	116	80	4	1.5	540	850	55 000	86 500
110	240	118	81	4	1	580	815	59 500	83 000
111.125 4.3750	214.312	115.888	84.138	3.5	1.5	610	980	62 500	100 000
	241.300	158.750	107.950	6.4	1.5	910	1 470	92 500	150 000
114.300 4.5000	228.600	115.888	84.138	3.5	2.3	645	1 060	65 500	108 000
	228.600	115.888	84.138	3.5	2.3	565	950	58 000	96 500
115	230	116	84	3	1.5	645	1 060	65 500	108 000
	330	228	124	6	1.5	1 490	2 150	152 000	219 000
120	260	130	87	4	1	730	1 060	74 500	108 000
125	230	116	84	4	1.5	645	1 060	65 500	108 000
125.298 4.9330	228.600	115.888	84.138	3.5	2.3	565	950	58 000	96 500
127	230	126	84	4	1.5	645	1 060	65 500	108 000
127.000 5.0000	228.600	115.888	84.138	3.5	2.3	645	1 060	65 500	108 000
	228.600	115.888	84.138	3.5	2.3	565	950	58 000	96 500
127.792 5.0312	228.600	115.888	84.138	3.5	2.3	645	1 060	65 500	108 000
	228.600	115.888	84.138	3.5	2.3	565	950	58 000	96 500
128	229	116	74	4	1	560	1 010	57 000	103 000
130	280	137	87.5	5	1.5	845	1 210	86 500	123 000
	299	137	87.5	5	1.5	845	1 210	86 500	123 000

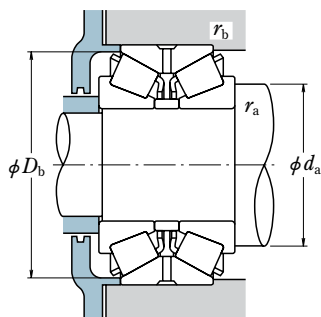

Dynamic Equivalent Load

$$P = X F_r + Y F_a$$

$F_a/F_r \leq e$		$F_a/F_r > e$	
X	Y	X	Y
1	Y_3	0.67	Y_2

Static Equivalent Load

$$P_0 = F_r + Y_0 F_a$$

The values of e , Y_2 , Y_3 , and Y_0 are given in the table below.

Bearing Numbers	Abutment and Fillet Dimensions (mm)				Constant e	Axial Load Factors			Mass (kg) approx.
	d_a	D_b	r_a max.	r_b max.		Y_2	Y_3	Y_0	
100KDE1801+L	124	171	2.5	1	0.73	1.4	0.92	0.90	7.5
100KDE2001+L	131	186	3	1.5	0.63	1.6	1.1	1.0	15.1
110KDE043+L	148	227	3	1	0.81	1.2	0.83	0.81	21.8
* H924045 / H924010D+L	143	203	3.5	1.5	0.67	1.5	1.0	0.98	17.1
* HH924349 / HH924310D+L	152	225	6.4	1.5	0.73	1.4	0.93	0.91	31.6
* HM926740 / HM926710D+L	152	220	3.5	2.3	0.74	1.4	0.92	0.90	20.5
* 97450 / 97901D+L	151	213	3.5	2.3	0.74	1.4	0.92	0.90	20.6
115KDE2301+L	151	220	2.5	1.5	0.74	1.4	0.92	0.90	20.7
115KDE3301+L	180	309	5	1.5	1.3	0.76	0.51	0.50	92.6
120KDE043+L	159	249	3	1	0.81	1.2	0.83	0.81	28.5
125KDE2301+L	157	220	3	1.5	0.74	1.4	0.92	0.90	19
* 97493 / 97901D+L	157	213	3.5	2.3	0.74	1.4	0.92	0.90	18.7
127KDE2301+L	158	220	3	1.5	0.74	1.4	0.92	0.90	19.6
* HM926747 / HM926710D+L	158	220	3.5	2.3	0.74	1.4	0.92	0.90	18.3
* 97500 / 97901D+L	157	213	3.5	2.3	0.74	1.4	0.92	0.90	18.4
* HM926749 / HM926710D+L	158	220	3.5	2.3	0.74	1.4	0.92	0.90	18.1
128KDE2201+L	162	218	2.5	1	1.1	0.96	0.64	0.63	18.6
130KDE43+L	172	262	4	1.5	0.83	1.2	0.81	0.79	34.7
130KDE2901+L	172	278	4	1.5	0.83	1.2	0.81	0.79	40.6

Note * Bearings marked * are inch design.

DOUBLE-ROW TAPERED ROLLER BEARINGS

KDE (TDO) Type, Double Cup, Single Cones, Steep Angle

Bore Diameter 150 – 342.900 mm

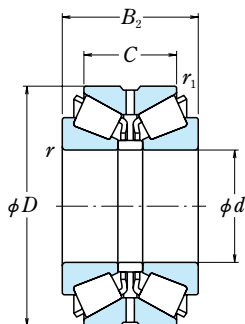

<i>d</i>	Boundary Dimensions (mm/inch)					Basic Load Ratings			
	<i>D</i>	<i>B</i> ₂	<i>C</i>	<i>r</i> min.	<i>r</i> ₁ min.	<i>C</i> _r (kN)	<i>C</i> _{0r} (kN)	<i>C</i> _r (kgf)	<i>C</i> _{0r} (kgf)
150	280	160	104	4	1	1 010	1 710	103 000	174 000
155	330	180	120	6	1.5	1 300	2 120	133 000	216 000
161.925 6.3750	374.650 14.7500	184.150 7.2500	130.175 5.1250	6.4	1.5	1 460	2 180	149 000	223 000
203.200 8.0000	406.400 16.0000	196.850 7.7500	127.000 5.0000	6.4	3.3	1 600	2 610	163 000	267 000
228.397 8.9920	431.800 17.0000	196.850 7.7500	111.125 4.3750	6.4	3.3	1 520	2 640	155 000	269 000
228.460 8.9945	431.800 17.0000	196.850 7.7500	111.125 4.3750	6.4	3.3	1 520	2 640	155 000	269 000
228.600 9.0000	488.950 19.2500	254.000 10.0000	152.400 6.0000	6.4	1.5	2 750	5 000	280 000	510 000
230	380 430 450	175 215 265	115 130 164	5 6 6	1.5 1.5 1.5	1 470 2 040 2 730	2 890 3 700 4 850	149 000 208 000 279 000	295 000 380 000 495 000
254.000 10.0000	533.400 21.0000	276.225 10.8750	165.100 6.5000	6.4	1.5	3 150	5 550	320 000	565 000
260	530	275	163.9	6	2.5	3 150	5 650	320 000	580 000
285.750 11.2500	501.650 19.7500	203.200 8.0000	120.650 4.7500	6.4	3.3	2 160	4 100	220 000	420 000
311.150 12.2500	558.800 22.0000	190.500 7.5000	111.125 4.3750	9.7	3.3	2 140	4 250	218 000	435 000
314.36	558.8	254	174	6	1.5	3 500	7 050	355 000	715 000
317.5	558.8	254	174	6	1.5	3 500	7 050	355 000	715 000
317.500 12.5000	622.300 24.5000	304.800 12.0000	174.625 6.8750	14.3	3.3	3 900	7 550	395 000	770 000
342.900 13.5000	457.098 17.9960	142.875 5.6250	101.600 4.0000	3.3	1.5	1 170	3 050	119 000	310 000

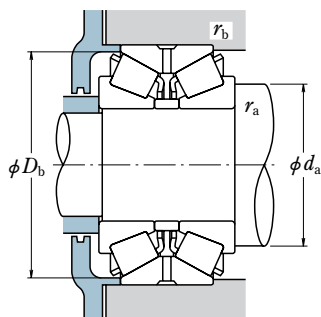

Dynamic Equivalent Load

$$P = XF_r + YF_a$$

$F_a/F_r \leq e$		$F_a/F_r > e$	
X	Y	X	Y
1	Y_3	0.67	Y_2

Static Equivalent Load

$$P_0 = F_r + Y_0 F_a$$

The values of e , Y_2 , Y_3 , and Y_0 are given in the table below.

Bearing Numbers	Abutment and Fillet Dimensions (mm)				Constant e	Axial Load Factors			Mass (kg) approx.
	d_a	D_b	r_a max.	r_b max.		Y_2	Y_3	Y_0	
150KDE2801+L 155KDE3301+L	189 208	265 310	3 5	1 1.5	0.81 0.81	1.2 1.2	0.84 0.84	0.82 0.82	38.5 68.5
* EE117063 / 117148D+L	217	355	6.4	1.5	0.71	1.4	0.96	0.93	89.3
* EE114080 / 114161D+L	260	386	6.4	3.3	0.79	1.3	0.85	0.83	102
* EE113089 / 113171D+L	287	410	6.4	3.3	0.88	1.1	0.77	0.75	105
* EE113091 / 113171D+L	287	410	6.4	3.3	0.88	1.1	0.77	0.75	105
* HH949549 / HH949510D+L	307	470	6.4	1.5	0.94	1.1	0.72	0.70	215
230KDE3801+L 230KDE4301A+L 230KDE4501+L	276 291 295	365 416 433	4 5 5	1.5 1.5 1.5	0.80 0.86 0.87	1.3 1.2 1.2	0.85 0.79 0.78	0.83 0.77 0.76	69.9 128 175
* HH953749 / HH953710D+L	332	511	6.4	1.5	0.94	1.1	0.72	0.70	265
260KDE5301A+L	337	510	5	2	0.94	1.1	0.72	0.70	259
* EE147112 / 147198D+L	350	483	6.4	3.3	0.83	1.2	0.81	0.79	151
* EE148122 / 148221D+L	377	521	9.7	3.3	0.88	1.1	0.77	0.75	173
314KDE5501+L	384	542	5	1.5	0.70	1.4	0.97	0.94	257
317KDE5501+L	386	542	5	1.5	0.70	1.4	0.97	0.94	249
* H961649 / H961610D+L	414	597	14.3	3.3	0.94	1.1	0.72	0.70	386
* LM961548 / LM961511D+L	378	444	3.3	1.5	0.71	1.4	0.95	0.93	59.4

Note * Bearings marked * are inch design.

DOUBLE-ROW TAPERED ROLLER BEARINGS

KDE (TDO) Type, Double Cup, Single Cones, Steep Angle

Bore Diameter 370 – 1 450 mm

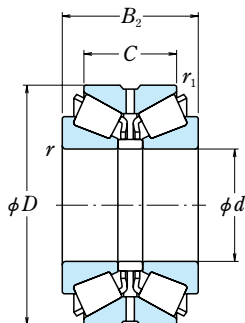

<i>d</i>	Boundary Dimensions (mm/inch)					Basic Load Ratings			
	<i>D</i>	<i>B</i> ₂	<i>C</i>	<i>r</i> min.	<i>r</i> ₁ min.	(kN)		(kgf)	
						<i>C</i> _r	<i>C</i> _{0r}	<i>C</i> _r	<i>C</i> _{0r}
370	680	280	188	7.5	4	4 400	8 500	450 000	865 000
400	650	280	180	6	2.5	3 800	8 400	385 000	855 000
	820	295	180	7.5	4	5 300	8 950	545 000	915 000
420	622.3	240	135	7.5	1.5	2 720	6 350	278 000	645 000
	850	300	200	7.5	4	5 750	12 500	585 000	1 280 000
580	900	300	200	7.5	4	5 950	13 400	605 000	1 360 000
	990	400	270	7.5	4	8 600	19 300	880 000	1 970 000
700	1 030	250	210	7.5	4	5 250	12 600	535 000	1 290 000
	1 030	280	210	7.5	4	6 050	15 100	615 000	1 540 000
780	1 150	330	210	7.5	4	7 450	18 500	755 000	1 880 000
850	1 250	360	235	7.5	4	8 650	21 300	885 000	2 170 000
950	1 500	540	380	9.5	4	15 500	44 500	1 580 000	4 500 000
980	1 200	150	100	6	3	2 580	8 350	263 000	850 000
1 450	1 900	460	280	9.5	2	15 000	48 000	1 530 000	4 900 000

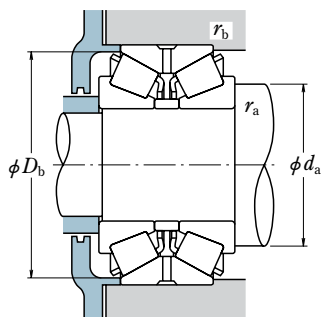

Dynamic Equivalent Load

$$P = XF_r + YF_a$$

$F_a/F_r \leq e$		$F_a/F_r > e$	
X	Y	X	Y
1	Y_3	0.67	Y_2

Static Equivalent Load

$$P_0 = F_r + Y_0 F_a$$

The values of e , Y_2 , Y_3 , and Y_0 are given in the table below.

Bearing Numbers	Abutment and Fillet Dimensions (mm)				Constant e	Axial Load Factors			Mass (kg) approx.
	d_a	D_b	r_a max.	r_b max.		Y_2	Y_3	Y_0	
370KDE6801E+L	452	652	6	3	0.70	1.4	0.97	0.94	417
400KDE6501A+L	478	628	5	2	0.87	1.2	0.78	0.76	345
400KDE8201+L	498	775	6	3	0.61	1.7	1.1	1.1	638
420KDE6201A1+L	493	610	6	1.5	1.3	0.80	0.54	0.52	232
540KDE8501+L	623	824	6	3	0.65	1.5	1.0	1.0	575
580KDE9001A+L	667	873	6	3	0.70	1.4	0.97	0.94	634
590KDE9901+L	695	954	6	3	0.67	1.5	1.0	0.98	1 140
700KDE1001A+L	786	1 004	6	3	0.70	1.4	0.97	0.94	674
700KDE1002A+L	790	1 004	6	3	0.70	1.4	0.97	0.94	749
780KDE1101+L	874	1 109	6	3	0.67	1.5	1.0	0.98	1 040
850KDE1201+L	949	1 209	6	3	0.65	1.5	1.0	1.0	1 320
950KDE1501+L	1 120	1 467	8	3	0.80	1.3	0.84	0.82	3 510
980KDE1201+L	1 046	1 177	5	2.5	0.68	1.5	0.99	0.97	341
1450KDE1901+L	1 582	1 868	8	2	0.83	1.2	0.81	0.79	3 240

DOUBLE-ROW TAPERED ROLLER BEARINGS

KF (TNA) Type, Double Cup, Single Cones

Bore Diameter 101.600 – 125 mm

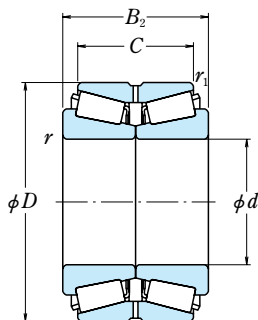

<i>d</i>	Boundary Dimensions (mm/inch)					Basic Load Ratings (kN) (kgf)			
	<i>D</i>	<i>B</i> ₂	<i>C</i>	<i>r</i> min.	<i>r</i> ₁ min.	<i>C</i> _r	<i>C</i> _{0r}	<i>C</i> _r	<i>C</i> _{0r}
101.600 4.0000	161.925 6.3750	82.547 3.2499	61.912 2.4375	3.5	0.6	310	570	31 500	58 500
	168.275 6.6250	92.075 3.6250	69.850 2.7500	3.5	0.8	380	685	39 000	70 000
	180.000 7.0866	104.775 4.1250	85.725 3.3750	3.5	0.8	440	750	45 000	76 500
	180.975 7.1250	104.775 4.1250	85.725 3.3750	3.5	1.5	440	750	45 000	76 500
	190.500 7.5000	127.000 5.0000	101.600 4.0000	3.5	1.5	605	1 000	61 500	102 000
	190.500 7.5000	127.000 5.0000	104.775 4.1250	3.5	1.5	665	1 040	68 000	107 000
104.775 4.1250	180.000 7.0866	104.775 4.1250	85.725 3.3750	3.5	0.8	440	750	45 000	76 500
	180.975 7.1250	104.775 4.1250	85.725 3.3750	3.5	1.5	440	750	45 000	76 500
110	170	70	55	2.5	0.6	300	500	31 000	51 000
114.300 4.5000	190.500 7.5000	106.362 4.1875	80.962 3.1875	3.5	1.5	510	925	52 000	94 500
	212.725 8.3750	142.875 5.6250	117.475 4.6250	3.5	1.5	975	1 620	99 500	165 000
	212.725 8.3750	142.875 5.6250	117.475 4.6250	3.5	1.5	820	1 400	83 500	143 000
	228.600 9.0000	115.888 4.5625	84.138 3.3125	3.5	2.3	565	950	58 000	96 500
115	190	106	80	4	1.5	510	925	52 000	94 500
	210	143	118	4	1.5	975	1 620	99 500	165 000
120	260	60	86	4	1	775	1 100	79 000	112 000
125	180	85	75	3	0.6	390	885	40 000	90 500
	235	142	114	4	1.5	875	1 580	89 000	161 000
	235	145	115	4	1.5	875	1 580	89 000	161 000

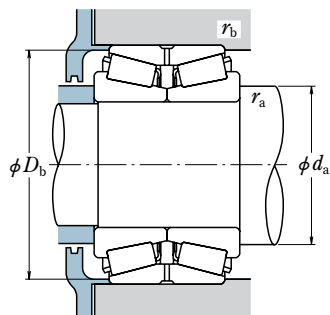

Dynamic Equivalent Load

$$P = XF_r + YF_a$$

$F_a/F_r \leq e$		$F_a/F_r > e$	
X	Y	X	Y
1	Y_3	0.67	Y_2

Static Equivalent Load

$$P_0 = F_r + Y_0 F_a$$

The values of e , Y_2 , Y_3 , and Y_0 are given in the table below.

Bearing Numbers	Abutment and Fillet Dimensions (mm)				Constant e	Axial Load Factors			Mass (kg) approx.
	d_a	D_b	r_a max.	r_b max.		Y_2	Y_3	Y_0	
* 101KF1651	120	155	3.5	0.6	0.47	2.1	1.4	1.4	5.9
* NA691 / 672D	121	161	3.5	0.8	0.47	2.1	1.4	1.4	7.3
* NA780 / 773D	124	171	3.5	0.8	0.39	2.6	1.8	1.7	10.2
* NA780 / 774D	124	171	3.5	1.5	0.39	2.6	1.8	1.7	10.4
* NA861 / 854D	125	180	3.5	1.5	0.33	3.0	2.0	2.0	14.5
* HH221449NA / HH221410D	126	183	3.5	1.5	0.33	3.0	2.0	2.0	14.4
* NA782 / 773D	125	171	3.5	0.8	0.39	2.6	1.8	1.7	9.8
* NA782 / 774D	125	171	3.5	1.5	0.39	2.6	1.8	1.7	9.9
110KF1701	127	165	2	0.6	0.41	2.5	1.7	1.6	5.0
* NA71450 / 71751D	136	182	3.5	1.5	0.42	2.4	1.6	1.6	10.9
* HH224346NA / HH224310D	140	205	3.5	1.5	0.33	3.1	2.1	2.0	21
* NA938 / 932D	139	201	3.5	1.5	0.33	3.1	2.1	2.0	21
* NA97450 / 97901D	151	218	3.5	2.3	0.74	1.4	0.9	0.9	20.7
115KF1901	137	182	3	1.5	0.42	2.4	1.6	1.6	10.7
115KF2101	141	204	3	1.5	0.33	3.1	2.1	2.0	20
120KF2601	156	246	2.5	1	0.44	2.3	1.5	1.5	27
125KF1801	143	176	2	0.5	0.31	3.3	2.2	2.2	7.0
125KF2302	159	226	2.5	1	0.37	2.7	1.8	1.8	25.6
125KF2301	159	226	2.5	1	0.37	2.7	1.8	1.8	25.9

Note * Bearings marked * are inch design.

DOUBLE-ROW TAPERED ROLLER BEARINGS

KF (TNA) Type, Double Cup, Single Cones

Bore Diameter 127.000 – 149.225 mm

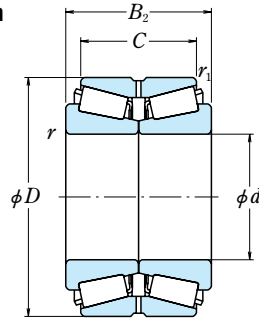

<i>d</i>	<i>D</i>	Boundary Dimensions (mm/inch)				Basic Load Ratings (kN) (kgf)			
		<i>B</i> ₂	<i>C</i>	<i>r</i> min.	<i>r</i> ₁ min.	<i>C</i> _r	<i>C</i> _{0r}	<i>C</i> _r	<i>C</i> _{0r}
127.000 5.0000	182.562 7.1875	85.725 3.3750	73.025 2.8750	3.5	0.8	390	885	40 000	90 500
	206.375 8.1250	107.950 4.2500	82.550 3.2500	3.5	0.8	545	1 060	56 000	108 000
	234.950 9.2500	142.875 5.6250	114.300 4.5000	3.5	1.5	875	1 580	89 000	161 000
	133	216	106	81	3.6	1.6	495	985	50 500
133.350 5.2500	215.900 8.5000	106.362 4.1875	80.962 3.1875	3.5	1.5	495	985	50 500	100 000
	136.525 5.3750	190.500 7.5000	85.725 3.3750	73.025 2.8750	3.5	0.8	370	880	37 500
139.700 5.5000	244.475 9.6250	107.950 4.2500	79.375 3.1250	3.5	1.5	570	1 020	58 000	104 000
	142.875 5.6250	200.025 7.8750	93.665 3.6876	73.025 2.8750	3.5	0.8	415	995	42 500
145	240	135	110	4	1	775	1 440	79 000	147 000
146.050 5.7500	236.538 9.3125	131.762 5.1875	106.362 4.1875	3.5	1.5	775	1 440	79 000	147 000
	236.538 9.3125	131.762 5.1875	106.362 4.1875	3.5	1.5	685	1 360	70 000	139 000
	241.300 9.5000	131.762 5.1875	106.362 4.1875	3.5	1.5	775	1 440	79 000	147 000
	241.300 9.5000	131.762 5.1875	106.362 4.1875	3.5	1.5	685	1 360	70 000	139 000
149.225 5.8750	236.538 9.3125	131.762 5.1875	106.362 4.1875	3.5	1.5	775	1 440	79 000	147 000
	236.538 9.3125	131.762 5.1875	106.362 4.1875	3.5	1.5	685	1 360	70 000	139 000
	241.300 9.5000	131.762 5.1875	106.362 4.1875	3.5	1.5	775	1 440	79 000	147 000
	241.300 9.5000	131.762 5.1875	106.362 4.1875	3.5	1.5	685	1 360	70 000	139 000

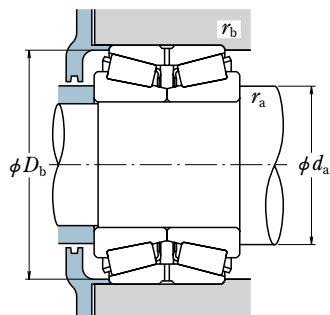

Dynamic Equivalent Load

$$P = XF_r + YF_a$$

$F_a/F_r \leq e$		$F_a/F_r > e$	
X	Y	X	Y
1	Y_3	0.67	Y_2

Static Equivalent Load

$$P_0 = F_r + Y_0 F_a$$

The values of e , Y_2 , Y_3 , and Y_0 are given in the table below.

Bearing Numbers	Abutment and Fillet Dimensions (mm)				Constant e	Axial Load Factors			Mass (kg) approx.
	d_a	D_b	r_a max.	r_b max.		Y_2	Y_3	Y_0	
* NA48291 / 48220D	145	177	3.5	0.8	0.31	3.3	2.2	2.2	7.0
* NA798 / 792D	152	199	3.5	0.8	0.46	2.2	1.5	1.4	13
* NA95500 / 95927D	160	226	3.5	1.5	0.37	2.7	1.8	1.8	25.4
133KF2101	160	208	3.6	1.6	0.49	2.1	1.4	1.4	14.1
* NA74525 / 74851D	160	208	3.5	1.5	0.49	2.1	1.4	1.4	14
* NA48390 / 48320D	155	185	3.5	0.8	0.32	3.1	2.1	2.1	7.3
* NA81550 / 81963D	172	235	3.5	1.5	0.35	2.9	1.9	1.9	19.1
* NA48686 / 48620D	162	194	3.5	0.8	0.34	3.0	2.0	2.0	8.6
145KF2402	171	229	2.5	1	0.32	3.2	2.1	2.1	22.1
* HM231140NA / HM231111D	171	227	3.5	1.5	0.32	3.2	2.1	2.1	19.7
* NA82576 / 82932D	173	228	3.5	1.5	0.44	2.3	1.5	1.5	20.6
* HM231140NA / HM231116D	171	230	3.5	1.5	0.32	3.2	2.1	2.1	21.3
* NA82576 / 82951D	173	230	3.5	1.5	0.44	2.3	1.5	1.5	21.9
* HM231149NA / HM231111D	173	227	3.5	1.5	0.32	3.2	2.1	2.1	18.9
* NA82587 / 82932D	175	228	3.5	1.5	0.44	2.3	1.5	1.5	19.8
* HM231149NA / HM231116D	173	230	3.5	1.5	0.32	3.2	2.1	2.1	20.5
* NA82587 / 82951D	175	230	3.5	1.5	0.44	2.3	1.5	1.5	21.1

Note * Bearings marked * are inch design.

DOUBLE-ROW TAPERED ROLLER BEARINGS

KF (TNA) Type, Double Cup, Single Cones

Bore Diameter 150 – 177.800 mm

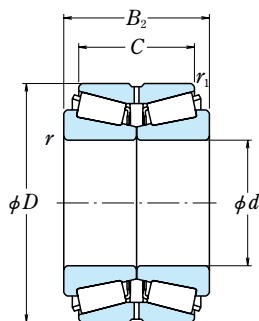

<i>d</i>	Boundary Dimensions (mm/inch)					Basic Load Ratings (kN) (kgf)			
	<i>D</i>	<i>B</i> ₂	<i>C</i>	<i>r</i> min.	<i>r</i> ₁ min.	<i>C</i> _r	<i>C</i> _{0r}	<i>C</i> _r	<i>C</i> _{0r}
150	250	142	112	4	1.5	885	1 660	90 000	169 000
	250	145	115	4	1.5	850	1 580	87 000	161 000
152.400 6.0000	244.475	107.950	79.375	3.5	1.5	570	1 020	58 000	104 000
	9.6250	4.2500	3.1250						
	254.000	142.875	111.125	3.5	1.5	885	1 660	90 000	169 000
	10.0000	5.6250	4.3750						
	257.000	142.875	111.125	3.5	1.5	885	1 660	90 000	169 000
	10.1181	5.6250	4.3750						
165	225	95	70	4	0.6	410	1 080	42 000	110 000
	290	143	111	4	1.5	930	1 880	95 000	192 000
165.100 6.5000	225.425	95.250	69.850	3.5	0.8	410	1 080	42 000	110 000
	8.8750	3.7500	2.7500						
	288.925	142.875	111.125	3.5	1.5	1 050	1 870	107 000	191 000
	11.3750	5.6250	4.3750						
	288.925	142.875	111.125	3.5	1.5	930	1 880	95 000	192 000
	11.3750	5.6250	4.3750						
	298.450	142.875	111.125	3.5	1.5	930	1 880	95 000	192 000
	11.7500	5.6250	4.3750						
165.496 6.5156	225.425	95.250	69.850	3.5	0.8	410	1 080	42 000	110 000
	8.8750	3.7500	2.7500						
170	260	90	65	3	1	575	1 030	58 500	105 000
	310	195	150	5	1.5	1 540	2 890	157 000	295 000
174.625 6.8750	247.650	103.188	84.138	3.5	0.8	555	1 290	56 500	131 000
	9.7500	4.0625	3.3125						
177.800 7.0000	247.650	103.188	84.138	3.5	0.8	595	1 410	60 500	143 000
	9.7500	4.0625	3.3125						
	282.575	107.950	79.375	3.5	1.5	615	1 200	62 500	123 000
	11.1250	4.2500	3.1250						
	288.925	142.875	111.125	5.5	1.5	1 050	1 870	107 000	191 000
	11.3750	5.6250	4.3750						
	288.925	142.875	111.125	5.5	1.5	930	1 880	95 000	192 000
	11.3750	5.6250	4.3750						

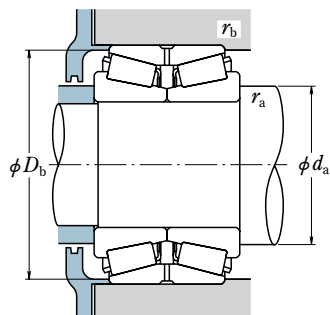

Dynamic Equivalent Load

$$P = XF_r + YF_a$$

$F_a/F_r \leq e$		$F_a/F_r > e$	
X	Y	X	Y
1	Y_3	0.67	Y_2

Static Equivalent Load

$$P_0 = F_r + Y_0 F_a$$

The values of e , Y_2 , Y_3 , and Y_0 are given in the table below.

Bearing Numbers	Abutment and Fillet Dimensions (mm)				Constant e	Axial Load Factors			Mass (kg) approx.
	d_a	D_b	r_a max.	r_b max.		Y_2	Y_3	Y_0	
150KF2502	181	243	2.5	1	0.41	2.5	1.7	1.6	25.1
150KF2501WA	181	243	3	1.5	0.41	2.5	1.7	1.6	26.5
* NA81600 / 81963D	178	235	3.5	1.5	0.35	2.9	1.9	1.9	16.7
* NA99600 / 99102D	182	245	3.5	1.5	0.41	2.5	1.7	1.6	25.9
* 152KF2551	182	246	3.5	1.5	0.41	2.5	1.7	1.6	26.9
165KF2201	186	219	3	0.6	0.38	2.6	1.8	1.7	10.7
165KF2951	203	278	2.5	1	0.47	2.1	1.4	1.4	38.3
* NA46790 / 46720D	186	219	3.5	0.8	0.38	2.6	1.8	1.7	10.8
* HM237536NA / HM237510D	201	278	3.5	1.5	0.32	3.2	2.1	2.1	35.7
* NA94650 / 94114D	203	277	3.5	1.5	0.47	2.1	1.4	1.4	37.5
* NA94650 / 94118D	203	282	3.5	1.5	0.47	2.1	1.4	1.4	41.5
* NA46791 / 46720D	186	219	3.5	0.8	0.38	2.6	1.8	1.7	10.7
170KF2601	194	251	2	0.8	0.39	2.6	1.7	1.7	15.1
170KF3101	209	297	3	1	0.33	3.0	2.0	2.0	59.6
* NA67787 / 67720D	198	241	3.5	0.8	0.44	2.3	1.5	1.5	14.9
* NA67790 / 67720D	200	241	3.5	0.8	0.44	2.3	1.5	1.5	14.5
* NA87700 / 87112D	210	273	3.5	1.5	0.42	2.4	1.6	1.6	23.4
* HM237545NA / HM237510D	209	278	5.5	1.5	0.32	3.2	2.1	2.1	31.9
* NA94700 / 94114D	211	277	5.5	1.5	0.47	2.1	1.4	1.4	33.7

Note * Bearings marked * are inch design.

DOUBLE-ROW TAPERED ROLLER BEARINGS

KF (TNA) Type, Double Cup, Single Cones

Bore Diameter 177.800 – 253.975 mm

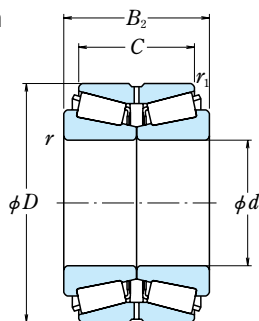

Boundary Dimensions (mm/inch)						Basic Load Ratings (kN) (kgf)			
<i>d</i>	<i>D</i>	<i>B</i> ₂	<i>C</i>	<i>r</i> min.	<i>r</i> ₁ min.	<i>C</i> _r	<i>C</i> _{0r}	<i>C</i> _r	<i>C</i> _{0r}
177.800 7.0000	298.450 11.7500	142.875 5.6250	111.125 4.3750	5.5	1.5	930	1 880	95 000	192 000
178	289	143	111	5.5	1.5	1 050	1 870	107 000	191 000
180	290	143	111	5.5	1.5	930	1 880	95 000	192 000
187.325 7.3750	320.675 12.6250	185.738 7.3125	138.112 5.4375	5.5	1.5	1 470	2 530	150 000	258 000
	320.675 12.6250	185.738 7.3125	138.112 5.4375	5.5	1.5	1 350	2 600	138 000	265 000
190.500 7.5000	260.350 10.2500	66.675 2.6250	50.800 2.0000	3.5	0.8	415	820	42 500	83 500
203.200 8.0000	276.225 10.8750	95.250 3.7500	73.025 2.8750	3.5	0.8	580	1 240	59 000	127 000
	317.500 12.5000	120.650 4.7500	88.900 3.5000	6.4	1.5	790	1 450	80 500	148 000
	317.500 12.5000	146.050 5.7500	111.125 4.3750	5.5	1.5	990	2 120	101 000	216 000
205	320	146	111	5	1.5	990	2 120	101 000	216 000
209.550 8.2500	317.500 12.5000	146.050 5.7500	111.125 4.3750	4.8	1.5	1 120	2 380	114 000	243 000
220	340	130	110	4	1.5	920	1 830	93 500	187 000
228.600 9.0000	355.600 14.0000	146.050 5.7500	111.125 4.3750	6.4	1.5	1 190	2 470	122 000	252 000
230	355	146	111	6	1.5	1 160	2 370	118 000	242 000
234.950 9.2500	311.150 12.2500	101.600 4.0000	73.025 2.8750	3.5	0.8	640	1 610	65 000	164 000
241.300 9.5000	368.300 14.5000	120.650 4.7500	85.725 3.3750	6.4	1.5	790	1 630	80 500	167 000
244.475 9.6250	349.148 13.7460	133.350 5.2500	101.600 4.0000	6.4	1.5	980	2 130	100 000	217 000
253.975 9.9990	347.662 13.6875	101.600 4.0000	69.850 2.7500	3.5	1.5	755	1 610	77 000	164 000

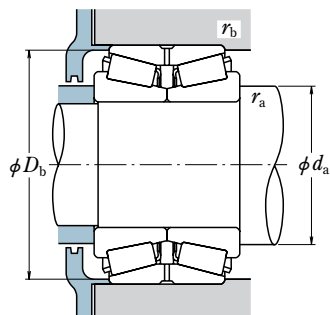

Dynamic Equivalent Load

$$P = X F_r + Y F_a$$

$F_a/F_r \leq e$		$F_a/F_r > e$	
X	Y	X	Y
1	Y_3	0.67	Y_2

Static Equivalent Load

$$P_0 = F_r + Y_0 F_a$$

The values of e , Y_2 , Y_3 , and Y_0 are given in the table below.

Bearing Numbers	Abutment and Fillet Dimensions (mm)				Constant e	Axial Load Factors			Mass (kg) approx.
	d_a	D_b	r_a max.	r_b max.		Y_2	Y_3	Y_0	
* NA94700 / 94118D	211	282	5.5	1.5	0.47	2.1	1.4	1.4	37.6
178KF2801	209	278	5.5	1.6	0.32	3.2	2.1	2.1	31.7
180KF2901	212	278	5.5	1.5	0.47	2.1	1.4	1.4	33.6
* H239649NA / H239612D	222	309	5.5	1.5	0.32	3.2	2.1	2.1	51.8
* NA222075 / 222127D	225	308	5.5	1.5	0.40	2.5	1.7	1.7	55.8
* NA537075 / 537103D	209	252	3.5	0.8	0.34	2.9	2.0	1.9	9.0
* LM241149NW / LM241110D	226	269	3.5	0.8	0.32	3.2	2.1	2.1	14.7
* NA132083 / 132126D	234	302	6.4	1.5	0.31	3.2	2.1	2.1	29.8
* NA93800 / 93127D	238	306	5.5	1.5	0.52	1.9	1.3	1.3	39.6
205KF3201	238	307	4	1.5	0.52	1.9	1.3	1.3	40.2
* 209KF3151	242	308	4.8	1.5	0.46	2.2	1.5	1.4	37.9
220KF3402	255	330	2.5	1	0.40	2.5	1.7	1.6	39.7
* NA130902 / 131401D	264	340	6.4	1.5	0.33	3.0	2.0	2.0	47.8
230KF3501WA	264	340	4	1	0.33	3.0	2.0	2.0	48.2
* LM446349NW / LM446310D	259	304	3.5	0.8	0.36	2.8	1.9	1.8	19.3
* NA170950 / 171451D	275	348	6.4	1.5	0.36	2.8	1.9	1.8	39.8
* NA127096 / 127136D	275	338	6.4	1.5	0.35	2.8	1.9	1.9	36
* LM249747NW / LM249710D	278	336	3.5	1.5	0.33	3.0	2.0	2.0	24

Note * Bearings marked * are inch design.

DOUBLE-ROW TAPERED ROLLER BEARINGS

KF (TNA) Type, Double Cup, Single Cones

Bore Diameter 254.000 – 406.400 mm

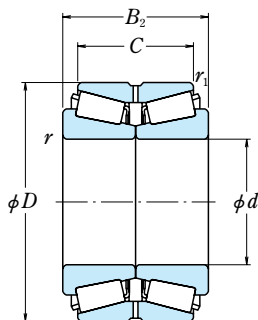

<i>d</i>	Boundary Dimensions (mm/inch)					Basic Load Ratings (kN) (kgf)			
	<i>D</i>	<i>B</i> ₂	<i>C</i>	<i>r</i> min.	<i>r</i> ₁ min.	<i>C</i> _r	<i>C</i> _{0r}	<i>C</i> _r	<i>C</i> _{0r}
254.000 10.0000	422.275 16.6250	173.038 6.8125	128.588 5.0625	6.4	1.5	1 950	3 700	199 000	375 000
	431.724 16.9970	173.038 6.8125	128.588 5.0625	6.4	1.5	1 670	3 200	170 000	325 000
259.82	390	146	112	5	1.5	1 260	2 440	128 000	249 000
	260	390	146	112	5	1.5	1 260	2 440	128 000
260.350 10.2500	400.050 15.7500	146.050 5.7500	107.950 4.2500	6.4	1.5	1 260	2 440	128 000	249 000
	431.724 16.9970	173.038 6.8125	128.588 5.0625	6.4	1.5	1 950	3 700	199 000	375 000
266.700 10.5000	352.425 13.8750	107.950 4.2500	82.550 3.2500	6.4	1.5	855	2 110	87 000	215 000
280.192 11.0312	406.400 16.0000	120.650 4.7500	85.725 3.3750	6.4	1.5	890	1 740	90 500	178 000
300.787 11.8420	438.048 17.2460	161.925 6.3750	123.825 4.8750	6.4	1.5	1 520	3 500	155 000	360 000
304.800 12.0000	393.700 15.5000	107.950 4.2500	82.550 3.2500	6.4	1.5	910	2 280	92 500	233 000
	438.048 17.2460	161.925 6.3750	123.825 4.8750	6.4	1.5	1 520	3 500	155 000	360 000
355.600 14.0000	444.500 17.5000	139.700 5.5000	98.425 3.8750	6.4	1.5	1 170	2 280	120 000	233 000
	501.650 19.7500	146.050 5.7500	107.950 4.2500	6.4	1.5	1 360	3 300	139 000	335 000
406.400 16.0000	514.350 20.2500	146.050 5.7500	107.950 4.2500	6.4	1.5	1 360	3 300	139 000	335 000
	574.675 22.6250	157.162 6.1875	106.362 4.1875	6.4	1.5	1 580	3 700	161 000	380 000

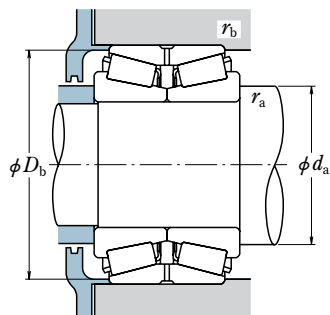

Dynamic Equivalent Load

$$P = XF_r + YF_a$$

$F_a/F_r \leq e$		$F_a/F_r > e$	
X	Y	X	Y
1	Y_3	0.67	Y_2

Static Equivalent Load

$$P_0 = F_r + Y_0 F_a$$

The values of e , Y_2 , Y_3 , and Y_0 are given in the table below.

Bearing Numbers	Abutment and Fillet Dimensions (mm)				Constant e	Axial Load Factors			Mass (kg) approx.
	d_a	D_b	r_a max.	r_b max.		Y_2	Y_3	Y_0	
* HM252344NA / HM252311D	301	408	6.4	1.5	0.33	3.0	2.0	2.0	86.8
* NA551002 / 551701D	299	408	6.8	1.5	0.33	3.0	2.0	2.0	92.1
* HM252343NA / HM252315D	301	413	6.4	1.5	0.33	3.0	2.0	2.0	93.4
260KF3901X	295	379	4	1.5	0.39	2.5	1.7	1.7	52.3
260KF3901	295	379	4	1.5	0.39	2.5	1.7	1.7	52.3
* NA221026 / 221576D	297	383	6.4	1.5	0.39	2.5	1.7	1.7	56.9
* HM252349NA / HM252315D	304	413	6.4	1.5	0.33	3.0	2.0	2.0	89.9
* LM251649NW / LM251610D	295	343	6.4	1.5	0.32	3.2	2.1	2.1	26.3
* NA101103 / 101601D	315	391	6.4	1.5	0.41	2.5	1.7	1.6	43.2
* NA329116 / 329173D	339	422	6.4	1.5	0.33	3.0	2.0	2.0	73.9
* L357049NW / L357010D	335	385	6.4	1.5	0.36	2.8	1.9	1.8	30.2
* NA329120 / 329173D	341	422	6.4	1.5	0.33	3.0	2.0	2.0	71.5
* NA291201 / 291751D	341	427	6.4	1.5	0.38	2.7	1.8	1.7	59.7
* NA231400 / 231976D	403	489	6.4	1.5	0.44	2.3	1.5	1.5	83.2
* NA231400 / 232026D	403	495	6.4	1.5	0.44	2.3	1.5	1.5	91.6
* NA285160 / 285228D	453	552	6.4	1.5	0.50	2.0	1.4	1.3	112

Note * Bearings marked * are inch design.

DOUBLE-ROW TAPERED ROLLER BEARINGS

KH (TDI) Type, Double Cone, Single Cups

Bore Diameter 100 – 130 mm

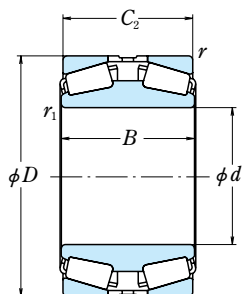

<i>d</i>	Boundary Dimensions (mm/inch)					Basic Load Ratings (kN) (kgf)			
	<i>D</i>	<i>B</i>	<i>C</i> ₂	<i>r</i> ₁ min.	<i>r</i> min.	<i>C</i> _r	<i>C</i> _{0r}	<i>C</i> _r	<i>C</i> _{0r}
100	150	110	110	1	2	385	780	39 500	79 500
101.600 4.0000	190.500 7.5000	127.000 5.0000	117.475 4.6250	1.5	3.3	605	1 000	61 500	102 000
	200.025 7.8750	127.000 5.0000	127.000 5.0000	1.5	3.3	605	1 000	61 500	102 000
105	170	90	90	2.5	2	395	810	40 500	82 500
107.950 4.2500	190.500 7.5000	101.600 4.0000	98.425 3.8750	1.5	3.3	510	925	52 000	94 500
	212.725 8.3750	152.400 6.0000	142.885 5.6254	3.3	3.3	820	1 400	83 500	143 000
114.300 4.5000	190.500 7.5000	101.600 4.0000	98.425 3.8750	1.5	3.3	510	925	52 000	94 500
	212.725 8.3750	152.400 6.0000	142.875 5.6250	3.3	3.3	975	1 620	99 500	165 000
	212.725 8.3750	152.400 6.0000	142.885 5.6254	3.3	3.3	820	1 400	83 500	143 000
120	170	120	120	2	1.5	425	915	43 500	93 000
120.000 4.7244	182.562 7.1875	80.000 3.1496	80.000 3.1496	0.8	3.3	390	885	40 000	90 500
120.650 4.7500	234.950 9.2500	152.400 6.0000	139.700 5.5000	6.4	3.3	875	1 580	89 000	161 000
127.000 5.0000	182.562 7.1875	76.200 3.0000	76.200 3.0000	1.5	3.3	390	885	40 000	90 500
	234.950 9.2500	152.400 6.0000	139.700 5.5000	5.0	3.3	875	1 580	89 000	161 000
	254.000 10.0000	171.450 6.7500	161.925 6.3750	3.3	6.4	975	1 600	99 000	164 000
130	190	120	120	1.5	1.5	490	1 100	50 000	112 000
	260	120	120	3	3	910	1 480	93 000	151 000

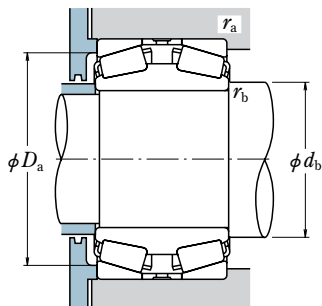

Dynamic Equivalent Load

$$P = XF_r + YF_a$$

$F_a/F_r \leq e$		$F_a/F_r > e$	
X	Y	X	Y
1	Y_3	0.67	Y_2

Static Equivalent Load

$$P_0 = F_r + Y_0 F_a$$

The values of e , Y_2 , Y_3 , and Y_0 are given in the table below.

Bearing Numbers	Abutment and Fillet Dimensions (mm)				Constant e	Axial Load Factors			Mass (kg) approx.
	d_b	D_a	r_a max.	r_b max.		Y_2	Y_3	Y_0	
100KH1501A+K	108	138	2	1	0.22	4.5	3.0	2.9	6.4
* 868D / 854+K	113	168	3.3	1.5	0.33	3.0	2.0	2.0	14.5
* 868D / 854X+K	113	172	3.3	1.5	0.33	3.0	2.0	2.0	18.2
105KH1701+K	118	155	2	2	0.32	3.2	2.1	2.1	8.0
* 71426D / 71750+K	121	171	3.3	1.5	0.42	2.4	1.6	1.6	11.8
* 946D / 932+K	123	187	3.3	3.3	0.33	3.1	2.1	2.0	23.9
* 71450D / 71750+K	125	171	3.3	1.5	0.42	2.4	1.6	1.6	11
* HH224346DD / HH224310+K	127	191	3.3	3.3	0.33	3.1	2.1	2.0	21.9
* 938D / 932+K	127	187	3.3	3.3	0.33	3.1	2.1	2.0	22.5
120KH1701A+K	128	158	1.5	1.5	0.25	4.0	2.7	2.6	8.0
* 120KH1851+K	132	167	3.3	0.8	0.31	3.3	2.2	2.2	7.8
* 95474D / 95925+K	146	212	3.3	6.4	0.37	2.7	1.8	1.8	28.1
* 48290D / 48220+K	136	167	3.3	1.5	0.31	3.3	2.2	2.2	6.7
* 95499D / 95925+K	147	212	3.3	5.0	0.37	2.7	1.8	1.8	26.7
* EE153053D / 153100+K	146	223	6.4	3.3	0.32	3.1	2.1	2.1	36.5
130KH1901+K	140	177	1.5	1.5	0.26	3.8	2.6	2.5	11.1
130KH2603+K	149	231	2.5	2.5	0.55	1.8	1.2	1.2	29.5

Note * Bearings marked * are inch design.

DOUBLE-ROW TAPERED ROLLER BEARINGS

KH (TDI) Type, Double Cone, Single Cups

Bore Diameter 130.005 – 152.400 mm

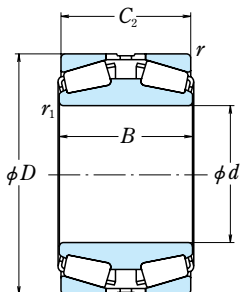

<i>d</i>	Boundary Dimensions (mm/inch)				Basic Load Ratings				
	<i>D</i>	<i>B</i>	<i>C</i> ₂	<i>r</i> ₁ min.	<i>r</i> min.	<i>C</i> _r (kN)	<i>C</i> _{0r} (kgf)	<i>C</i> _r	<i>C</i> _{0r}
130.005 5.1183	215.900 8.5000	123.825 4.8750	123.825 4.8750	1.5	3.3	495	985	50 500	100 000
130.175 5.1250	215.900 8.5000	101.600 4.0000	101.600 4.0000	1.5	3.3	495	985	50 500	100 000
133.350 5.2500	196.850 7.7500	92.075 3.6250	92.075 3.6250	1.5	3.3	495	1 010	50 500	103 000
	215.900 8.5000	95.250 3.7500	95.250 3.7500	1.5	3.3	495	985	50 500	100 000
135	230	120	120	1	2.5	760	1 480	77 500	151 000
136.525 5.3750	225.425 8.8750	120.650 4.7500	120.650 4.7500	1.5	3.3	760	1 480	77 500	151 000
139.700 5.5000	200.025 7.8750	75.408 2.9688	77.788 3.0625	0.8	3.3	390	915	39 500	93 500
	295.275 11.6250	171.450 6.7500	165.100 6.5000	3.3	6.4	1 230	2 080	125 000	212 000
140	210 300	53 150	53 150	2.5 1.5	2 4	305 1 180	530 1 830	31 000 120 000	54 000 187 000
146.050 5.7500	317.500 12.5000	171.450 6.7500	161.925 6.3750	13.5	6.8	1 510	2 380	154 000	243 000
149.225 5.8750	236.538 9.3125	105.346 4.1475	106.362 4.1875	1.5	3.3	685	1 360	70 000	139 000
152.400 6.0000	222.250 8.7500	84.138 3.3125	84.138 3.3125	1.5	1.5	490	1 060	50 000	108 000
	244.475 9.6250	92.075 3.6250	87.312 3.4375	1.5	3.3	570	1 020	58 000	104 000
	254.000 10.0000	158.750 6.2500	158.750 6.2500	1.5	3.3	885	1 660	90 000	169 000
	298.450 11.7500	111.125 4.3750	107.950 4.2500	3.3	3.3	960	1 450	98 000	148 000
	317.500 12.5000	171.450 6.7500	161.925 6.3750	9.7	6.8	1 510	2 380	154 000	243 000

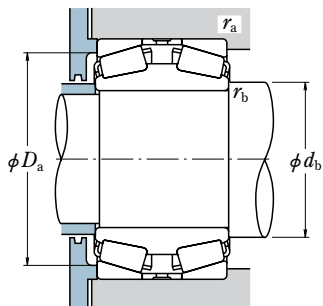

Dynamic Equivalent Load

$$P = XF_r + YF_a$$

$F_a/F_r \leq e$		$F_a/F_r > e$	
X	Y	X	Y
1	Y_3	0.67	Y_2

Static Equivalent Load

$$P_0 = F_r + Y_0 F_a$$

The values of e , Y_2 , Y_3 , and Y_0 are given in the table below.

Bearing Numbers	Abutment and Fillet Dimensions (mm)				Constant e	Axial Load Factors			Mass (kg) approx.
	d_b	D_a	r_a max.	r_b max.		Y_2	Y_3	Y_0	
* 74510D / 74850+K	145	195	3.3	1.5	0.49	2.1	1.4	1.4	17.2
* 74512D / 74850+K	145	195	3.3	1.5	0.49	2.1	1.4	1.4	14.7
* 67390D / 67322+K	142	180	3.3	1.5	0.34	2.9	2.0	1.9	9.3
* 133KH2151+K	147	195	3.3	1.5	0.49	2.1	1.4	1.4	13.5
135KH2301+K	148	207	2	1	0.33	3.0	2.0	2.0	20.8
* H228649D / H228610+K	149	204	3.3	1.5	0.33	3.0	2.0	2.0	19
* 48680D / 48620+K	151	185	3.3	0.8	0.34	3.0	2.0	2.0	7.9
* EE455048D / 455116+K	162	256	6.4	3.3	0.31	3.3	2.2	2.2	55.4
140KH30+K	157	195	2	2	0.40	2.5	1.7	1.6	6.4
140KH3002+K	161	264	3	1.5	0.55	1.8	1.2	1.2	50.2
* HH234040D / HH234018+K	180	279	6.8	13.5	0.33	3.1	2.1	2.0	62.7
* 82587D / 82931+K	160	213	3.3	1.5	0.44	2.3	1.5	1.5	17.5
* M231649D / M231610+K	164	207	1.5	1.5	0.33	3.0	2.0	2.0	11.1
* 81601D / 81962+K	167	225	3.3	1.5	0.35	2.9	1.9	1.9	15.3
* 99603D / 99100+K	165	230	3.3	1.5	0.41	2.5	1.7	1.6	29.6
* EE517060D / 517117+K	176	272	3.3	3.3	0.33	3.0	2.0	2.0	34.2
* HH234048D / HH234018+K	179	279	6.8	9.7	0.33	3.1	2.1	2.0	60.7

Note * Bearings marked * are inch design.

DOUBLE-ROW TAPERED ROLLER BEARINGS

KH (TDI) Type, Double Cone, Single Cups

Bore Diameter 155.575 – 199.974 mm

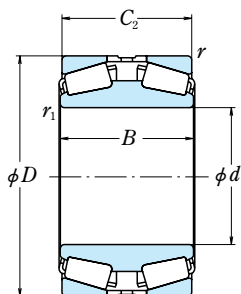

<i>d</i>	Boundary Dimensions (mm/inch)					Basic Load Ratings			
	<i>D</i>	<i>B</i>	<i>C</i> ₂	<i>r</i> ₁ min.	<i>r</i> min.	(kN) <i>C</i> _r	<i>C</i> _{0r}	(kgf) <i>C</i> _r	<i>C</i> _{0r}
155.575 6.1250	247.650 9.7500	122.238 4.8125	122.238 4.8125	1.5	3.3	910	1 790	93 000	182 000
160	340	136	150	1.5	4	1 400	2 140	143 000	219 000
165.100 6.5000	225.425 8.8750	76.200 3.0000	79.375 3.1250	0.8	3.3	410	1 080	42 000	110 000
173	350	155	155	5	4	1 430	2 410	146 000	246 000
174.625 6.8750	288.925 11.3750	123.825 4.8750	123.825 4.8750	1.5	3.3	1 050	1 870	107 000	191 000
177.800 7.0000	247.650 9.7500	90.488 3.5625	90.488 3.5625	1.5	3.3	555	1 290	56 500	131 000
	279.400 11.0000	112.712 4.4375	112.710 4.4374	1.5	3.3	785	1 540	80 000	157 000
	288.925 11.3750	123.825 4.8750	123.825 4.8750	1.5	3.3	1 050	1 870	107 000	191 000
	288.925 11.3750	123.825 4.8750	123.825 4.8750	1.5	3.3	930	1 880	95 000	192 000
	288.925 11.3750	158.750 6.2500	158.750 6.2500	1.5	3.3	1 050	1 870	107 000	191 000
187.325 7.3750	298.450 11.7500	123.825 4.8750	123.825 4.8750	1.5	3.3	930	1 880	95 000	192 000
	319.964 12.5970	161.920 6.3748	168.280 6.6252	3.3	4.8	1 270	2 400	129 000	245 000
190.500 7.5000	320.675 12.6250	161.925 6.3750	168.275 6.6250	3.3	4.8	1 470	2 530	150 000	258 000
	317.500 12.5000	133.350 5.2500	133.350 5.2500	6.4	3.3	990	2 120	101 000	216 000
195	305	120	120	3	2.5	1 050	2 020	108 000	206 000
199.974 7.8730	317.500 12.5000	133.350 5.2500	133.350 5.2500	6.4	3.3	990	2 120	101 000	216 000

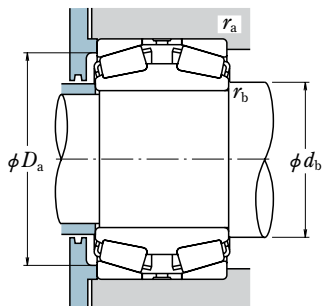

Dynamic Equivalent Load

$$P = XF_r + YF_a$$

$F_a/F_r \leq e$		$F_a/F_r > e$	
X	Y	X	Y
1	Y_3	0.67	Y_2

Static Equivalent Load

$$P_0 = F_r + Y_0 F_a$$

The values of e , Y_2 , Y_3 , and Y_0 are given in the table below.

Bearing Numbers	Abutment and Fillet Dimensions (mm)				Constant e	Axial Load Factors			Mass (kg) approx.
	d_b	D_a	r_a max.	r_b max.		Y_2	Y_3	Y_0	
* H432549D / H432510+K	167	226	3.3	1.5	0.37	2.7	1.8	1.8	22.4
160KH3401+K	182	300	3	1.5	0.55	1.8	1.2	1.2	63
* 46790D / 46720+K	175	208	3.3	0.8	0.38	2.6	1.8	1.7	9.7
173KH3501+K	201	311	3	4	0.43	2.3	1.6	1.5	69.3
* HM237542D / HM237510+K	190	266	3.3	1.5	0.32	3.2	2.1	2.1	31.3
* 67790D / 67720+K	187	228	3.3	1.5	0.44	2.3	1.5	1.5	13.3
* 82680D / 82620+K	191	253	3.3	1.5	0.53	1.9	1.3	1.2	24.9
* HM237546D / HM237510+K	191	266	3.3	1.5	0.32	3.2	2.1	2.1	30.5
* 94706D / 94113+K	192	261	3.3	1.5	0.47	2.1	1.4	1.4	32.1
* HM237546DD / HM237510+K	191	266	3.3	1.5	0.32	3.2	2.1	2.1	36.7
* 94706D / 94118+K	192	265	3.3	1.5	0.47	2.1	1.4	1.4	36.3
* 187KH3151+K	206	287	4.8	3.3	0.40	2.5	1.7	1.7	52.4
* H239649D / H239612+K	204	292	4.8	3.3	0.32	3.2	2.1	2.1	51.2
* 93751D / 93125+K	216	288	3.3	6.4	0.52	1.9	1.3	1.3	43
195KH3001+K	211	282	2	2	0.37	2.7	1.8	1.8	31.9
* 93788D / 93125+K	221	288	3.3	6.4	0.52	1.9	1.3	1.3	40

Note * Bearings marked * are inch design.

DOUBLE-ROW TAPERED ROLLER BEARINGS

KH (TDI) Type, Double Cone, Single Cups

Bore Diameter 200 – 235 mm

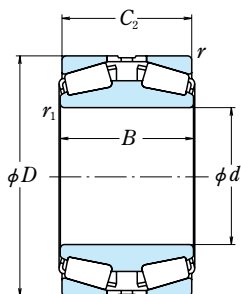

<i>d</i>	Boundary Dimensions (mm/inch)					Basic Load Ratings			
	<i>D</i>	<i>B</i>	<i>C</i> ₂	<i>r</i> ₁ min.	<i>r</i> min.	<i>C</i> _r (kN)	<i>C</i> _{0r}	<i>C</i> _r (kgf)	<i>C</i> _{0r}
200	420	138	138	5	5	1 740	2 750	177 000	280 000
203.200 8.0000	292.100 11.5000	107.950 4.2500	107.950 4.2500	1.5	3.3	930	2 100	94 500	214 000
	317.500 12.5000	133.350 5.2500	133.350 5.2500	6.4	3.3	990	2 120	101 000	216 000
	365.049 14.3720	152.400 6.0000	158.750 6.2500	3.3	3.3	1 500	2 690	153 000	274 000
206.375 8.1250	282.575 11.1250	87.312 3.4375	87.312 3.4375	0.8	3.3	630	1 600	64 000	163 000
	336.550 13.2500	184.150 7.2500	180.975 7.1250	1.5	3.3	1 790	3 800	182 000	390 000
210	365	170	170	4	4	1 740	3 400	177 000	345 000
216.103 8.5080	330.200 13.0000	142.875 5.6250	152.400 6.0000	3.3	3.3	1 090	2 260	111 000	231 000
219.075 8.6250	358.775 14.1250	200.025 7.8750	196.850 7.7500	1.5	6.4	1 890	3 950	192 000	405 000
220.662 8.6875	314.325 12.3750	115.888 4.5625	115.888 4.5625	1.5	3.3	1 020	2 390	104 000	243 000
225.425 8.8750	355.600 14.0000	165.100 6.5000	165.100 6.5000	8.0	1.5	1 190	2 470	122 000	252 000
228.600 9.0000	355.600 14.0000	165.100 6.5000	165.100 6.5000	8.0	1.5	1 190	2 470	122 000	252 000
	425.450 16.7500	165.100 6.5000	177.800 7.0000	3.5	6.4	2 200	4 000	224 000	405 000
234.950 9.2500	327.025 12.8750	93.662 3.6875	93.662 3.6875	1.5	3.3	805	1 880	82 000	192 000
	384.175 15.1250	209.550 8.2500	209.550 8.2500	1.5	6.4	2 090	4 450	213 000	455 000
235	375	170	170	3	3	1 850	3 800	189 000	385 000

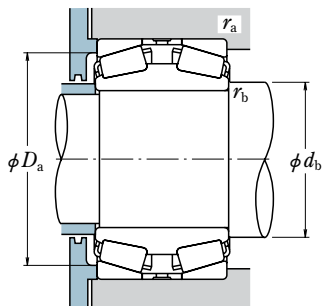

Dynamic Equivalent Load

$$P = XF_r + YF_a$$

$F_a/F_r \leq e$		$F_a/F_r > e$	
X	Y	X	Y
1	Y_3	0.67	Y_2

Static Equivalent Load

$$P_0 = F_r + Y_0 F_a$$

The values of e , Y_2 , Y_3 , and Y_0 are given in the table below.

Bearing Numbers	Abutment and Fillet Dimensions (mm)				Constant e	Axial Load Factors			Mass (kg) approx.
	d_b	D_a	r_a max.	r_b max.		Y_2	Y_3	Y_0	
200KH4201+K	241	382	4	4	0.40	2.5	1.7	1.6	93.3
* 203KH2951+K	215	271	3.3	1.5	0.33	3.0	2.0	2.0	24.3
* 93801D / 93125+K	222	288	3.3	6.4	0.52	1.9	1.3	1.3	39.1
* EE420800D / 421437+K	229	332	3.3	3.3	0.42	2.4	1.6	1.6	68.5
* 67985D / 67920+K	216	261	3.3	0.8	0.51	2.0	1.3	1.3	16.8
* H242649D / H242610+K	222	306	3.3	1.5	0.33	3.0	2.0	2.0	64.2
210KH3601+K	234	330	3	3	0.42	2.4	1.6	1.6	74
* 9977D / 9920+K	232	301	3.3	3.3	0.55	1.8	1.2	1.2	43.2
* H244849D / H244810+K	236	323	6.4	1.5	0.33	3.0	2.0	2.0	77.8
* M244249D / M244210+K	233	292	3.3	1.5	0.33	3.0	2.0	2.0	29.6
* EE130888D / 131400+K	251	329	1.5	8.0	0.33	3.0	2.0	2.0	57.7
* EE130903D / 131400+K	253	329	1.5	8.0	0.33	3.0	2.0	2.0	56.7
* EE700090D / 700167+K	259	384	6.4	3.5	0.33	3.0	2.0	2.0	110
* 8576D / 8520+K	248	304	3.3	1.5	0.41	2.5	1.7	1.6	24.4
* H247549D / H247510+K	251	344	6.4	1.5	0.33	3.0	2.0	2.0	95.8
235KH3701+K	255	345	2.5	2.5	0.33	3.0	2.0	2.0	70.9

Note * Bearings marked * are inch design.

DOUBLE-ROW TAPERED ROLLER BEARINGS

KH (TDI) Type, Double Cone, Single Cups

Bore Diameter 241.224 – 273.050 mm

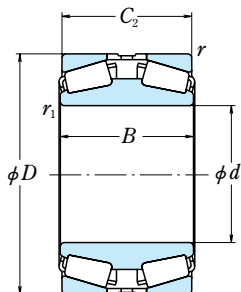

<i>d</i>	Boundary Dimensions (mm/inch)					Basic Load Ratings			
	<i>D</i>	<i>B</i>	<i>C</i> ₂	<i>r</i> ₁ min.	<i>r</i> min.	(kN) <i>C</i> _r	<i>C</i> _{0r}	(kgf) <i>C</i> _r	<i>C</i> _{0r}
241.224 9.4970	355.600 14.0000	107.950 4.2500	107.950 4.2500	1.5	3.3	980	2 130	100 000	217 000
241.300 9.5000	355.524 13.9970	109.525 4.3120	109.525 4.3120	3.3	3.3	980	2 130	100 000	217 000
241.478 9.5070	349.148 13.7460	107.950 4.2500	107.950 4.2500	1.5	3.3	980	2 130	100 000	217 000
244.475 9.6250	327.025 12.8750	92.075 3.6250	92.075 3.6250	1.5	3.3	755	1 840	77 000	188 000
247.650 9.7500	406.400 16.0000	219.075 8.6250	215.900 8.5000	3.3	6.4	2 630	5 850	268 000	595 000
254.000 10.0000	355.600 14.0000	92.862 3.6560	92.710 3.6500	1.5	3.3	790	1 630	80 500	167 000
	358.775 14.1250	130.175 5.1250	130.175 5.1250	3.3	3.3	1 300	3 100	133 000	315 000
	438.150 17.2500	165.100 6.5000	165.100 6.5000	3.3	6.4	2 130	3 950	217 000	405 000
	444.500 17.5000	133.350 5.2500	133.350 5.2500	3.3	6.4	1 700	3 000	174 000	305 000
259.5	481	250	250	2.5	5	3 450	7 100	350 000	725 000
260	440	144	144	5	4	1 770	4 150	181 000	420 000
	440	144	144	5	5	1 870	3 500	191 000	360 000
260.350 10.2500	365.125 14.3750	107.950 4.2500	107.950 4.2500	3.3	6.4	990	2 200	101 000	224 000
269.875 10.6250	381.000 15.0000	136.525 5.3750	136.525 5.3750	3.3	3.3	1 360	3 200	138 000	325 000
273.050 10.7500	393.700 15.5000	130.180 5.1252	130.180 5.1252	2.5	2.0	1 200	2 570	123 000	262 000

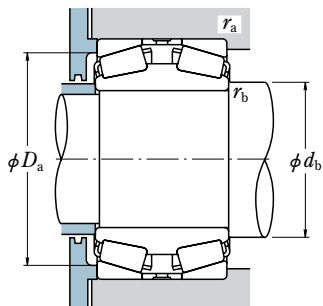

Dynamic Equivalent Load

$$P = XF_r + YF_a$$

$F_a/F_r \leq e$		$F_a/F_r > e$	
X	Y	X	Y
1	Y_3	0.67	Y_2

Static Equivalent Load

$$P_0 = F_r + Y_0 F_a$$

The values of e , Y_2 , Y_3 , and Y_0 are given in the table below.

Bearing Numbers	Abutment and Fillet Dimensions (mm)				Constant e	Axial Load Factors			Mass (kg) approx.
	d_b	D_a	r_a max.	r_b max.		Y_2	Y_3	Y_0	
* EE127094D / 127140+K	257	328	3.3	1.5	0.35	2.8	1.9	1.9	36.8
* 241KH3551+K	259	328	3.3	3.3	0.35	2.8	1.9	1.9	37.1
* EE127097D / 127135+K	257	325	3.3	1.5	0.35	2.8	1.9	1.9	33.8
* LM247748D / LM247710+K	256	306	3.3	1.5	0.49	2.1	1.4	1.4	21.6
* HH249949D / HH249910+K	268	366	6.4	3.3	0.33	3.0	2.0	2.0	115
* EE171000D / 171400+K	266	331	3.3	1.5	0.36	2.8	1.9	1.8	27.1
* M249748D / M249710+K	269	335	3.3	3.3	0.33	3.0	2.0	2.0	42
* EE738101D / 738172+K	283	400	6.4	3.3	0.36	2.8	1.9	1.8	107
* EE822101D / 822175+K	283	405	6.4	3.3	0.34	2.9	2.0	1.9	86.7
259KH4801+K	288	429	4	2	0.45	2.2	1.5	1.5	213
260KH31+K	301	407	3	4	0.35	2.9	1.9	1.9	95.8
260KH4402+K	290	402	4	4	0.42	2.4	1.6	1.6	93
* EE134103D / 134143+K	277	339	6.4	3.3	0.37	2.7	1.8	1.8	34.4
* M252349D / M252310+K	287	356	3.3	3.3	0.33	3.0	2.0	2.0	48.6
* 273KH3951+K	291	368	2.0	2.5	0.40	2.5	1.7	1.6	49.8

Note * Bearings marked * are inch design.

DOUBLE-ROW TAPERED ROLLER BEARINGS

KH (TDI) Type, Double Cone, Single Cups

Bore Diameter 279.400 – 333.375 mm

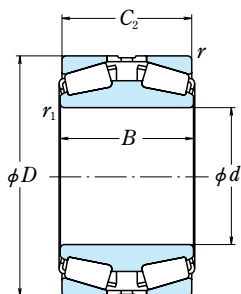

<i>d</i>	Boundary Dimensions (mm/inch)					Basic Load Ratings			
	<i>D</i>	<i>B</i>	<i>C</i> ₂	<i>r</i> ₁ min.	<i>r</i> min.	<i>C</i> _r (kN)	<i>C</i> _{0r}	<i>C</i> _r (kgf)	<i>C</i> _{0r}
279.400 11.0000	469.900 18.5000	166.688 6.5625	169.862 6.6875	6.4	3.3	2 030	4 150	207 000	420 000
279.578 11.0070	380.898 14.9960	117.475 4.6250	117.475 4.6250	1.5	3.3	1 060	2 990	108 000	305 000
285	500	200	200	6	5	2 980	5 800	305 000	590 000
285.750 11.2500	380.898 14.9960	117.475 4.6250	117.475 4.6250	1.5	3.3	1 060	2 990	108 000	305 000
300.038 11.8125	422.275 16.6250	150.812 5.9375	150.812 5.9375	3.3	3.3	1 700	4 100	173 000	420 000
304.648 11.9940	438.048 17.2460	131.762 5.1875	131.762 5.1875	3.3	3.3	1 520	3 500	155 000	360 000
	438.048 17.2460	134.938 5.3125	133.350 5.2500	3.3	4.8	1 530	3 500	156 000	355 000
304.800 12.0000	495.300 19.5000	134.938 5.3125	137.952 5.4312	1.5	3.3	1 840	3 550	188 000	365 000
	558.800 22.0000	285.750 11.2500	285.750 11.2500	3.3	6.4	4 250	8 200	435 000	840 000
305.003 12.0080	438.048 17.2460	134.938 5.3125	133.350 5.2500	3.3	4.8	1 530	3 500	156 000	355 000
305.054 12.0100	500.000 19.6850	200.000 7.8740	200.000 7.8740	3.3	6.4	2 880	6 050	294 000	620 000
310	440	110	110	4	3	1 250	2 780	128 000	283 000
317.500 12.5000	422.275 16.6250	128.588 5.0625	128.588 5.0625	1.5	3.3	1 360	3 500	138 000	355 000
	447.675 17.6250	158.750 6.2500	158.750 6.2500	3.3	3.3	1 920	4 700	196 000	480 000
330	540	186	186	5	5	2 950	7 450	300 000	760 000
333.375 13.1250	469.900 18.5000	166.690 6.5626	166.690 6.5626	3.3	3.3	2 100	5 200	215 000	530 000

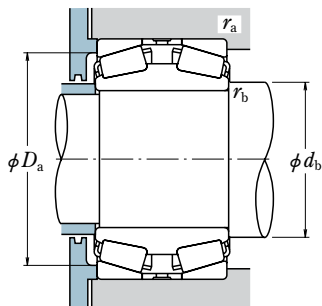

Dynamic Equivalent Load

$$P = XF_r + YF_a$$

$F_a/F_r \leq e$		$F_a/F_r > e$	
X	Y	X	Y
1	Y_3	0.67	Y_2

Static Equivalent Load

$$P_0 = F_r + Y_0 F_a$$

The values of e , Y_2 , Y_3 , and Y_0 are given in the table below.

Bearing Numbers	Abutment and Fillet Dimensions (mm)				Constant e	Axial Load Factors			Mass (kg) approx.
	d_b	D_a	r_a max.	r_b max.		Y_2	Y_3	Y_0	
* EE722111D / 722185+K	313	431	3.3	6.4	0.38	2.7	1.8	1.7	119
* LM654645D / LM654610+K	296	355	3.3	1.5	0.43	2.3	1.6	1.5	41
285KH5001A+K	318	456	4	5	0.35	2.8	1.9	1.9	170
* LM654648D / LM654610+K	300	355	3.3	1.5	0.43	2.3	1.6	1.5	38.5
* HM256849D / HM256810+K	318	395	3.3	3.3	0.34	3.0	2.0	2.0	66.7
* EE329117D / 329172+K	324	408	3.3	3.3	0.33	3.0	2.0	2.0	66.3
* EE129121D / 129172+K	325	407	4.8	3.3	0.42	2.4	1.6	1.6	65.6
* EE941206D / 941950+K	329	455	3.3	1.5	0.40	2.5	1.7	1.7	103
* EE790119D / 790221+K	341	506	6.4	3.3	0.39	2.5	1.7	1.7	307
* EE129123D / 129172+K	325	407	4.8	3.3	0.42	2.4	1.6	1.6	65.4
** HM858548D / HM858511+K	333	457	6.4	3.3	0.33	3.0	2.0	2.0	164
310KH4401+K	331	413	2.5	3	0.37	2.7	1.8	1.8	53.2
* LM258649D / LM258610+K	333	399	3.3	1.5	0.33	3.1	2.1	2.0	49.7
* HM259049D / HM259010+K	335	418	3.3	3.3	0.33	3.0	2.0	2.0	79.6
330KH5401+K	373	497	4	4	0.33	3.0	2.0	2.0	184
* 333KH4651+K	352	440	3.3	3.3	0.33	3.0	2.0	2.0	91.4

Note * Bearings marked * are inch design.
 ** The maximum outside diameter is listed and its tolerance is negative (See table 2.4.2 on page A 24).

DOUBLE-ROW TAPERED ROLLER BEARINGS

KH (TDI) Type, Double Cone, Single Cups

Bore Diameter 340 – 406 mm

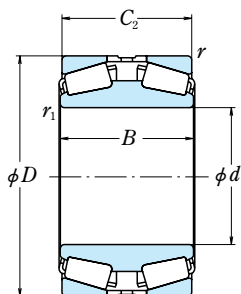

<i>d</i>	Boundary Dimensions (mm/inch)					Basic Load Ratings			
	<i>D</i>	<i>B</i>	<i>C</i> ₂	<i>r</i> ₁ min.	<i>r</i> min.	<i>C</i> _r (kN)	<i>C</i> _{0r} (kgf)	<i>C</i> _r	<i>C</i> _{0r}
340	520	133	133	5	5	2 020	4 100	206 000	420 000
	580	190	190	6	5	2 690	5 150	274 000	525 000
	580	241	241	5	5	3 800	7 750	385 000	790 000
342.900 13.5000	533.400	146.050	139.700	3.3	3.3	1 810	3 600	185 000	365 000
	21.0000	5.7500	5.5000						
346.075 13.6250	571.500	163.512	163.512	3.3	6.4	2 700	5 050	275 000	515 000
	22.5000	6.4375	6.4375						
355.600 14.0000	488.950	174.625	174.625	1.5	3.3	1 140	3 300	116 000	340 000
	19.2500	6.8750	6.8750						
360	444.500	114.300	112.712	1.5	3.3	1 400	3 750	142 000	385 000
	17.5000	4.5000	4.4375						
368.300 14.5000	457.200	120.650	120.650	6	5	2 100	4 350	214 000	445 000
	18.0000	4.7500	4.7500						
374.574 14.7470	523.875	185.738	185.738	3.3	6.4	2 950	7 450	300 000	760 000
	20.6250	7.3125	7.3125						
380	546.100	193.675	193.675	3.3	6.4	3 150	8 000	320 000	815 000
	21.5000	7.6250	7.6250						
384.175 15.1250	530	200	200	5	5	2 380	6 200	242 000	630 000
	21.5000	7.6250	7.6250						
385	546.100	193.675	193.675	3.3	6.4	3 150	8 000	320 000	815 000
	21.5000	7.6250	7.6250						
393.700 15.5000	530	180	180	2	4	2 130	5 300	217 000	540 000
	21.5000	7.2500	7.2500						
400	546.100	120.650	141.288	3.3	6.4	1 400	3 300	142 000	335 000
	21.5000	4.7500	5.5625						
	530	105	120						
406	590	142	142	3	3	2 300	5 000	235 000	510 000
	590	144.5	144.5						
	590	144.5	144.5						
406	530	105	120	1.5	4	1 340	3 350	137 000	345 000
	590	142	142						
	590	144.5	144.5						
406	635	224	224	3	6	4 200	10 800	425 000	1 100 000
	590	142	142						
	590	144.5	144.5						

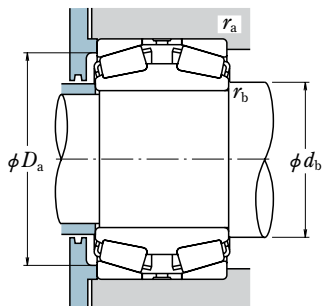

Dynamic Equivalent Load

$$P = XF_r + YF_a$$

$F_a/F_r \leq e$		$F_a/F_r > e$	
X	Y	X	Y
1	Y_3	0.67	Y_2

Static Equivalent Load

$$P_0 = F_r + Y_0 F_a$$

The values of e , Y_2 , Y_3 , and Y_0 are given in the table below.

Bearing Numbers	Abutment and Fillet Dimensions (mm)				Constant e	Axial Load Factors			Mass (kg) approx.
	d_b	D_a	r_a max.	r_b max.		Y_2	Y_3	Y_0	
340KH30+K	382	484	4	4	0.39	2.6	1.7	1.7	105
340KH31+K	377	530	4	5	0.39	2.6	1.7	1.7	205
340KH5801+K	376	531	4	4	0.37	2.7	1.8	1.8	265
* EE971355D / 972100+K	372	497	3.3	3.3	0.33	3.0	2.0	2.0	114
* EE536136D / 536225+K	381	529	6.4	3.3	0.33	3.0	2.0	2.0	172
* HM262749D / HM262710+K	366	457	3.3	3.3	0.33	3.0	2.0	2.0	104
* L163149D / L163110+K	369	423	3.3	1.5	0.31	3.3	2.2	2.1	41
* LM263149D / LM263110+K	370	435	3.3	1.5	0.32	3.2	2.1	2.1	50.5
360KH30+K	391	505	4	5	0.39	2.6	1.7	1.7	111
360KH31B+K	399	551	4	5	0.39	2.6	1.7	1.7	235
* HM265049D / HM265010+K	390	487	6.4	3.3	0.33	3.0	2.0	2.0	135
* HM266445D / HM266410+K	402	508	6.4	3.3	0.33	3.0	2.0	2.0	159
380KH5302+K	404	495	4	4	0.33	3.0	2.0	2.0	134
* HM266449D / HM266410+K	407	508	6.4	3.3	0.33	3.0	2.0	2.0	150
385KH5301+K	404	497	3	2	0.38	2.7	1.8	1.7	117
* EE234157D / 234215+K	419	507	6.4	3.3	0.48	2.1	1.4	1.4	92.2
400KH5301+K	418	499	3	1	0.56	1.8	1.2	1.2	69.1
400KH5901+K	428	553	2.5	2.5	0.42	2.4	1.6	1.6	138
400KH5902+K	430	550	4	4	0.42	2.4	1.6	1.6	131
406KH6301+K	451	593	5	2.5	0.33	3.0	2.0	2.0	287

Note * Bearings marked * are inch design.

DOUBLE-ROW TAPERED ROLLER BEARINGS

KH (TDI) Type, Double Cone, Single Cups

Bore Diameter 406.400 – 458 mm

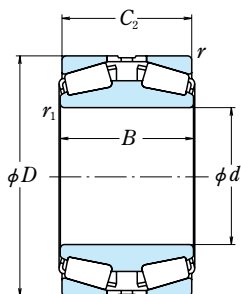

<i>d</i>	Boundary Dimensions (mm/inch)					Basic Load Ratings			
	<i>D</i>	<i>B</i>	<i>C</i> ₂	<i>r</i> ₁ min.	<i>r</i> min.	<i>C</i> _r (kN)	<i>C</i> _{0r} (kgf)	<i>C</i> _r	<i>C</i> _{0r}
406.400 16.0000	546.100 21.5000	120.650 4.7500	141.288 5.5625	1.5	6.4	1 400	3 300	142 000	335 000
	546.100 21.5000	138.112 5.4375	138.112 5.4375	1.5	6.4	1 730	4 300	176 000	435 000
406.476 16.0030	673.049 26.4980	195.262 7.6875	195.262 7.6875	3.3	6.4	3 850	7 950	390 000	810 000
415.000 16.3386	593.000 23.3465	152.000 5.9843	152.000 5.9843	3.5	3.5	2 350	5 400	240 000	550 000
419.100 16.5000	622.300 24.5000	155.575 6.1250	152.705 6.0120	3.5	6.8	2 770	6 150	283 000	630 000
419.227 16.5050	736.448 28.9940	406.400 16.0000	406.400 16.0000	6.4	6.4	8 550	19 900	875 000	2 030 000
431.800 17.0000	571.500 22.5000	130.175 5.1250	133.350 5.2500	1.5	3.3	1 850	4 650	188 000	470 000
	635.000 25.0000	173.038 6.8125	173.038 6.8125	6.4	6.4	3 200	7 250	325 000	740 000
440	650	157	157	6	6	2 810	6 200	287 000	635 000
447.675 17.6250	635.000 25.0000	223.838 8.8125	223.838 8.8125	3.3	6.4	3 250	8 650	330 000	885 000
448	635	224	224	3	6	4 200	10 800	425 000	1 100 000
453.000 17.8346	593.000 23.3465	136.000 5.3543	136.000 5.3543	1.5	3.3	1 920	5 000	196 000	510 000
457.073 17.9950	749.300 29.5000	412.750 16.2500	419.100 16.5000	3.3	6.4	8 700	21 200	885 000	2 160 000
457.200 18.0000	596.900 23.5000	130.175 5.1250	133.350 5.2500	1.5	3.3	1 790	4 750	182 000	480 000
	596.900 23.5000	133.350 5.2500	136.525 5.3750	1.5	3.3	1 920	5 000	196 000	510 000
	863.498 33.9960	368.300 14.5000	368.300 14.5000	6.4	6.4	9 500	19 700	965 000	2 010 000
458	830.5	377	377	7.5	7.5	9 100	19 700	930 000	2 010 000

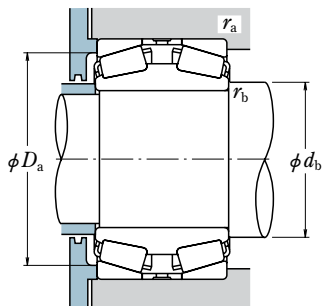

Dynamic Equivalent Load

$$P = XF_r + YF_a$$

$F_a/F_r \leq e$		$F_a/F_r > e$	
X	Y	X	Y
1	Y_3	0.67	Y_2

Static Equivalent Load

$$P_0 = F_r + Y_0 F_a$$

The values of e , Y_2 , Y_3 , and Y_0 are given in the table below.

Bearing Numbers	Abutment and Fillet Dimensions (mm)				Constant e	Axial Load Factors			Mass (kg) approx.
	d_b	D_a	r_a max.	r_b max.		Y_2	Y_3	Y_0	
* EE234161D / 234215+K	423	507	6.4	1.5	0.48	2.1	1.4	1.4	84.7
* LM767749D / LM767710+K	425	511	6.4	1.5	0.47	2.1	1.4	1.4	89.9
* EE623161D / 623265+K	448	620	6.4	3.3	0.36	2.8	1.9	1.8	292
* 415KH5951+K	441	555	3.5	3.5	0.48	2.1	1.4	1.4	139
* EE261650D / 262450+K	452	580	6.8	3.5	0.38	2.6	1.8	1.7	168
* EE323166D / 323290+K	463	662	6.4	6.4	0.37	2.7	1.8	1.8	775
* EE239171D / 239225+K	450	542	3.3	1.5	0.38	2.6	1.8	1.7	92
* EE931170D / 931250+K	468	595	6.4	6.4	0.32	3.1	2.1	2.1	193
440KH30+K	488	606	5	5	0.39	2.6	1.7	1.7	183
* M270749D / M270710+K	475	591	6.4	3.3	0.33	3.0	2.0	2.0	232
448KH6301+K	472	593	5	2.5	0.33	3.0	2.0	2.0	238
* 453KH5951+K	473	564	3.3	1.5	0.47	2.1	1.4	1.4	98.8
* EE925179D / 925295+K	497	686	6.4	3.3	0.31	3.3	2.2	2.2	760
* EE244181D / 244235+K	475	565	3.3	1.5	0.40	2.5	1.7	1.6	96.9
* L770849D / L770810+K	476	566	3.3	1.5	0.47	2.1	1.4	1.4	98.9
* 457KH8651+K	517	783	6.4	6.4	0.37	2.7	1.8	1.8	1 030
458KH8301+K	512	750	6	6	0.40	2.5	1.7	1.6	937

Note * Bearings marked * are inch design.

DOUBLE-ROW TAPERED ROLLER BEARINGS

KH (TDI) Type, Double Cone, Single Cups

Bore Diameter 460 – 596 mm

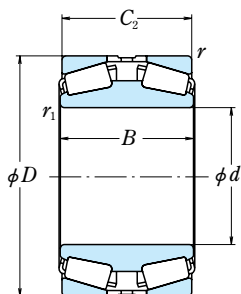

<i>d</i>	Boundary Dimensions (mm/inch)					Basic Load Ratings			
	<i>D</i>	<i>B</i>	<i>C</i> ₂	<i>r</i> ₁ min.	<i>r</i> min.	(kN)		(kgf)	
						<i>C</i> _r	<i>C</i> _{0r}	<i>C</i> _r	<i>C</i> _{0r}
460	760	240	240	7.5	7.5	5 350	11 600	545 000	1 190 000
479.425 18.8750	679.450 26.7500	238.125 9.3750	238.125 9.3750	3.3	6.4	4 800	12 800	490 000	1 300 000
480	790	248	248	7.5	7.5	5 700	12 500	580 000	1 280 000
482.600 19.0000	615.950 24.2500	158.750 6.2500	158.750 6.2500	3.3	6.4	2 380	6 900	243 000	705 000
489.026 19.2530	634.873 24.9950	153.988 6.0625	153.988 6.0625	3.3	3.3	2 350	6 350	240 000	650 000
489.25	655 700	260 260	260 260	1.5 2	4 5	3 850 4 750	11 000 13 500	395 000 485 000	1 120 000 1 370 000
508.000 20.0000	762.000 30.0000	219.075 8.6250	219.075 8.6250	6.4	6.4	4 750	11 400	485 000	1 160 000
519.112 20.4375	736.600 29.0000	258.762 10.1875	258.762 10.1875	3.3	6.4	5 000	13 300	510 000	1 360 000
530	780 870	185 272	185 272	6 7.5	6 7.5	4 150 6 800	9 350 14 500	425 000 695 000	950 000 1 470 000
536.575 21.1250	761.873 29.9950	269.875 10.6250	269.875 10.6250	3.3	6.4	5 550	15 100	565 000	1 540 000
540	710	140	150	5	4	2 180	5 650	222 000	575 000
550	750	130	150	6	5	2 630	6 350	269 000	650 000
558.800 22.0000	736.600 29.0000	196.850 7.7500	196.850 7.7500	3.3	6.4	3 950	11 200	400 000	1 150 000
560	920	280	280	7.5	7.5	7 300	15 400	740 000	1 570 000
570	710	140	150	4	4	2 230	6 450	228 000	660 000
571.500 22.5000	812.800 32.0000	285.750 11.2500	285.750 11.2500	3.3	6.4	6 850	18 600	700 000	1 900 000
590	770	150	160	6	5	2 600	7 300	265 000	740 000
595.312 23.4375	844.550 33.2500	296.862 11.6875	296.862 11.6875	3.3	6.4	6 850	19 000	700 000	1 930 000
596	760	115.25	115	6	5	1 500	5 000	152 000	510 000

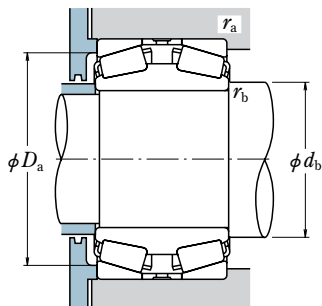

Dynamic Equivalent Load

$$P = XF_r + YF_a$$

$F_a/F_r \leq e$		$F_a/F_r > e$	
X	Y	X	Y
1	Y_3	0.67	Y_2

Static Equivalent Load

$$P_0 = F_r + Y_0 F_a$$

The values of e , Y_2 , Y_3 , and Y_0 are given in the table below.

Bearing Numbers	Abutment and Fillet Dimensions (mm)				Constant e	Axial Load Factors			Mass (kg) approx.
	d_b	D_a	r_a max.	r_b max.		Y_2	Y_3	Y_0	
460KH31+K	530	700	6	6	0.39	2.6	1.7	1.7	448
* M272749D / M272710+K	506	635	6.4	3.3	0.34	3.0	2.0	1.9	290
480KH31+K	530	726	6	6	0.39	2.6	1.7	1.7	517
* 482KH6151+K	501	582	6.4	3.3	0.37	2.7	1.8	1.8	118
* LM772749D / LM772710+K	508	602	3.3	3.3	0.47	2.1	1.4	1.4	125
489KH6501+K	507	616	3	1	0.38	2.7	1.8	1.7	252
489KH7001+K	520	653	4	1.5	0.36	2.8	1.9	1.8	333
* EE531201D / 531300+K	551	710	6.4	6.4	0.38	2.6	1.8	1.7	370
* M275349D / M275310+K	550	687	6.4	3.3	0.33	3.0	2.0	2.0	363
530KH30+K	568	731	5	5	0.37	2.7	1.8	1.8	321
530KH31+K	581	800	6	6	0.39	2.6	1.7	1.7	661
* M276449D / M276410+K	567	710	6.4	3.3	0.33	3.0	2.0	2.0	409
540KH7101+K	568	675	3	4	0.40	2.5	1.7	1.6	151
550KH7501+K	583	707	4	5	0.49	2.1	1.4	1.4	196
* LM377449D / LM377410+K	583	696	6.4	3.3	0.35	2.9	1.9	1.9	237
560KH31+K	635	845	6	6	0.39	2.6	1.7	1.7	762
570KH7101+K	593	680	3	3	0.32	3.1	2.1	2.1	130
* M278749D-N3 / M278710+K	603	759	6.4	3.3	0.33	3.0	2.0	2.0	502
590KH7701+K	620	732	4	5	0.39	2.6	1.7	1.7	191
* M280049D / M280010+K	630	790	6.4	3.3	0.33	3.0	2.0	2.0	558
596KH7601+K	633	723	4	5	0.44	2.3	1.5	1.5	137

Note * Bearings marked * are inch design.

DOUBLE-ROW TAPERED ROLLER BEARINGS

KH (TDI) Type, Double Cone, Single Cups

Bore Diameter 600 – 1 290 mm

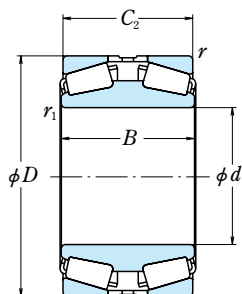

<i>d</i>	Boundary Dimensions (mm/inch)					Basic Load Ratings			
	<i>D</i>	<i>B</i>	<i>C</i> ₂	<i>r</i> ₁ min.	<i>r</i> min.	(kN)		(kgf)	
						<i>C</i> _r	<i>C</i> _{0r}	<i>C</i> _r	<i>C</i> _{0r}
600	760 820	115 160	115 160	6 6	5 6	1 500 3 300	5 000 8 300	152 000 340 000	510 000 845 000
609.600 24.0000	787.400 31.0000	171.450 6.7500	171.450 6.7500	3.3	6.4	3 450	9 600	350 000	980 000
670	980 1 090	230 336	230 336	7.5 7.5	7.5 7.5	6 300 10 300	14 600 23 500	640 000 1 050 000	1 490 000 2 400 000
690	980	355	355	6	6	9 400	26 000	960 000	2 650 000
710	1 030 1 150	236 345	236 345	7.5 9.5	7.5 9.5	6 600 11 100	16 100 26 100	675 000 1 130 000	1 650 000 2 660 000
714.375 28.1250	1 016.000 40.0000	339.725 13.3750	339.725 13.3750	3.3	6.4	9 500	26 200	970 000	2 670 000
750	1 090 1 220	250 365	250 365	7.5 9.5	7.5 9.5	7 350 12 500	18 100 29 500	750 000 1 270 000	1 850 000 3 000 000
790	970	125.25	125	5	5	2 310	7 350	236 000	750 000
825.500 32.5000	1 168.400 46.0000	412.750 16.2500	412.750 16.2500	4.8	12.7	13 000	38 000	1 320 000	3 900 000
850	1 250	370	370	7.5	7.5	12 200	32 000	1 250 000	3 300 000
863.600 34.0000	1 130.300 44.5000	323.850 12.7500	323.850 12.7500	4.7	12.7	9 800	31 000	995 000	3 150 000
880	1 220	340	340	4	7.5	10 700	30 000	1 090 000	3 050 000
939.800 37.0000	1 333.500 52.5000	463.550 18.2500	463.550 18.2500	4.8	12.7	15 700	46 000	1 600 000	4 700 000
1 000	1 320	240	240	7.5	7.5	7 400	20 500	755 000	2 090 000
1 005	1 360	400	400	7.5	7.5	13 300	40 500	1 350 000	4 150 000
1 180	1 660	510	510	9.5	9.5	21 500	63 500	2 200 000	6 500 000
1 290	1 690	400	400	7.5	7.5	16 100	53 000	1 650 000	5 400 000

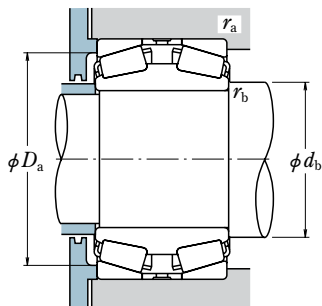

Dynamic Equivalent Load

$$P = XF_r + YF_a$$

$F_a/F_r \leq e$		$F_a/F_r > e$	
X	Y	X	Y
1	Y_3	0.67	Y_2

Static Equivalent Load

$$P_0 = F_r + Y_0 F_a$$

The values of e , Y_2 , Y_3 , and Y_0 are given in the table below.

Bearing Numbers	Abutment and Fillet Dimensions (mm)				Constant e	Axial Load Factors			Mass (kg) approx.
	d_b	D_a	r_a max.	r_b max.		Y_2	Y_3	Y_0	
600KH7601+K	635	723	4	5	0.44	2.3	1.5	1.5	133
600KH8201+K	637	774	5	5	0.42	2.4	1.6	1.6	258
* EE649241D / 649310+K	634	749	6.4	3.3	0.37	2.7	1.8	1.8	216
670KH30+K	717	920	6	6	0.37	2.7	1.8	1.8	601
670KH31+K	733	1 008	6	6	0.37	2.7	1.8	1.8	1 270
690KH9801+K	729	917	5	5	0.35	2.9	1.9	1.9	891
710KH30+K	785	965	6	6	0.37	2.7	1.8	1.8	671
710KH31+K	800	1 055	8	8	0.37	2.7	1.8	1.8	1 440
* M383240D-N1 / M383210+K	756	953	6.4	3.3	0.35	2.9	1.9	1.9	924
750KH30+K	830	1 025	6	6	0.37	2.7	1.8	1.8	798
750KH31+K	855	1 125	8	8	0.37	2.7	1.8	1.8	1 730
790KH9701+K	824	931	4	4	0.36	2.8	1.9	1.8	211
* 825KH1151+K	873	1 089	12.7	4.8	0.33	3.0	2.0	2.0	1 490
850KH1201+K	905	1 166	6	6	0.40	2.5	1.7	1.6	1 600
* LM286249D / LM286210+K	901	1 067	12.7	4.7	0.33	3.0	2.0	2.0	915
880KH1201+K	928	1 151	6	3	0.34	2.9	2.0	1.9	1 260
* LM287849D / LM287810+K	996	1 246	12.7	4.8	0.33	3.0	2.0	2.0	2 120
1000KH1301+K	1 053	1 257	6	6	0.33	3.0	2.0	2.0	907
1005KH1301+K	1 054	1 281	6	6	0.42	2.4	1.6	1.6	1 730
1180KH1601+K	1 248	1 561	8	8	0.35	2.9	1.9	1.9	3 610
1290KH1601+K	1 348	1 606	6	6	0.35	2.8	1.9	1.9	2 500

Note * Bearings marked * are inch design.

DOUBLE-ROW TAPERED ROLLER BEARINGS

KDH (TDI) Type, Double Cone, Single Cups, Steep Angle

Bore Diameter 100 – 260 mm

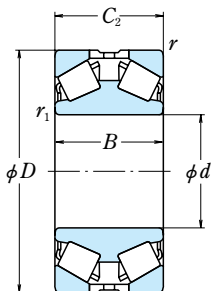

<i>d</i>	Boundary Dimensions (mm/inch)					Basic Load Ratings			
	<i>D</i>	<i>B</i>	<i>C</i> ₂	<i>r</i> ₁ min.	<i>r</i> min.	<i>C</i> _r (kN)	<i>C</i> _{0r} (kN)	<i>C</i> _r (kgf)	<i>C</i> _{0r} (kgf)
100	215	105	105	3	3	510	720	52 000	73 000
	215	105	110	1	3	625	900	64 000	92 000
	250	120	120	2.5	3	800	1 120	81 500	114 000
	250	120	120	2.5	3	695	955	71 000	97 500
110	240	118	118	1	3	750	1 080	76 500	110 000
114.300 4.5000	228.600 9.0000	98.860 3.8921	107.950 4.2500	1.5	3.3	645	1 060	65 500	108 000
120	230	120	120	1	2	725	1 290	73 500	131 000
	260	130	130	1	3	875	1 340	89 000	137 000
125	230	100	108	1.5	2.5	645	1 060	65 500	108 000
	305	180	180	4	3	1 270	2 020	130 000	206 000
127.000 5.0000	228.600 9.0000	151.244 5.9545	160.338 6.3125	1.5	3.3	565	950	58 000	96 500
150	320	144	144	5	4	1 110	1 750	113 000	179 000
170	360	144	144	2.5	4	1 110	2 130	113 000	218 000
	360	144	160	2.5	4	1 160	1 840	119 000	187 000
180	320	104	104	4	4	795	1 350	81 500	138 000
	330	190	190	1.5	5	1 610	3 200	164 000	325 000
190	320	104	104	3	3	815	1 410	83 000	144 000
200	360	170	170	1.5	4	1 300	2 360	132 000	240 000
210	355	130	127	6	3	1 030	2 340	105 000	239 000
	440	175	244	5	6	2 070	3 350	211 000	340 000
	480	230	230	6	6	3 000	5 150	305 000	525 000
215.900 8.5000	355.600 14.0000	130.175 5.1250	127.000 5.0000	6.4	3.3	1 030	2 340	105 000	239 000
228.600 9.0000	431.800 17.0000	158.750 6.2500	158.750 6.2500	6.4	6.4	1 520	2 640	155 000	269 000
	431.800 17.0000	177.800 7.0000	177.800 7.0000	5.0	5.0	1 980	3 600	202 000	365 000
260	389.5	105	105	1.5	3	945	1 880	96 000	192 000
	458.5	155	155	5	5	1 760	3 300	179 000	340 000

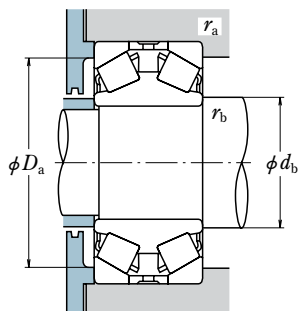

Dynamic Equivalent Load

$$P = XF_r + YF_a$$

$F_a/F_r \leq e$		$F_a/F_r > e$	
X	Y	X	Y
1	Y_3	0.67	Y_2

Static Equivalent Load

$$P_0 = F_r + Y_0 F_a$$

The values of e , Y_2 , Y_3 , and Y_0 are given in the table below.

Bearing Numbers	Abutment and Fillet Dimensions (mm)				Constant e	Axial Load Factors			Mass (kg) approx.
	d_b	D_a	r_a max.	r_b max.		Y_2	Y_3	Y_0	
100KDH2102+K	119	188	2.5	2.5	0.81	1.2	0.83	0.81	16.8
100KDH2101+K	111	183	2.5	1	0.81	1.2	0.83	0.81	18.3
100KDH2501+K	122	216	2.5	2	0.71	1.4	0.95	0.93	29.2
100KDH2502+K	124	216	2.5	2	0.90	1.1	0.75	0.73	28
110KDH2401+K	126	207	2.5	1	0.81	1.2	0.83	0.81	24.6
* 114KDH2251+K	133	201	3.3	1.5	0.74	1.4	0.92	0.90	19.7
120KDH2301+K	133	198	2	1	0.80	1.3	0.85	0.83	23.3
120KDH2601+K	137	224	2.5	1	0.81	1.2	0.83	0.81	32.8
125KDH2301+K	138	203	2	1.5	0.74	1.4	0.92	0.90	18.5
125KDH3001+K	156	267	2.5	3	0.73	1.4	0.93	0.91	64.9
* 97500D / 97900+K	138	198	3.3	1.5	0.74	1.4	0.92	0.90	25.4
150KDH3201+K	176	277	3	4	0.89	1.1	0.76	0.74	53.4
170KDH3605+K	204	312	3	2	1.1	0.95	0.64	0.62	72.6
170KDH3602+K	195	309	3	2	1.1	0.92	0.62	0.61	70.7
180KDH3201+K	203	285	3	3	0.74	1.4	0.92	0.90	34.8
180KDH3301+K	200	291	4	1.5	0.58	1.7	1.2	1.1	72.6
190KDH3201+K	211	290	2.5	2.5	0.76	1.3	0.88	0.86	32.3
200KDH3601+K	219	317	3	1.5	0.97	1.0	0.70	0.68	72.7
210KDH3501+K	241	321	2.5	5	0.59	1.7	1.1	1.1	53.8
210KDH4402+K	243	384	5	4	1.1	0.92	0.62	0.61	151
210KDH4801+K	251	416	5	5	0.70	1.4	0.97	0.94	215
* 96851D / 96140+K	244	321	3.3	6.4	0.59	1.7	1.1	1.1	52.1
* EE113090D / 113170+K	259	378	6.4	6.4	0.88	1.1	0.77	0.75	99.5
* 228KDH4351+K	257	382	5.0	5.0	0.93	1.1	0.73	0.71	117
260KDH3801+K	277	358	2.5	1.5	0.87	1.2	0.78	0.76	42.7
260KDH4501A+K	293	411	4	4	0.87	1.2	0.78	0.76	110

Note * Bearings marked * are inch design.

DOUBLE-ROW TAPERED ROLLER BEARINGS

KDH (TDI) Type, Double Cone, Single Cups, Steep Angle

Bore Diameter 260.350 – 540 mm

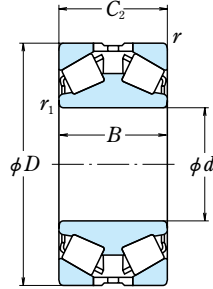

Boundary Dimensions (mm/inch)						Basic Load Ratings (kN) (kgf)			
<i>d</i>	<i>D</i>	<i>B</i>	<i>C</i> ₂	<i>r</i> ₁ min.	<i>r</i> min.	<i>C</i> _r	<i>C</i> _{0r}	<i>C</i> _r	<i>C</i> _{0r}
260.350 10.2500	419.100 16.5000	155.575 6.1250	158.750 6.2500	3.3	3.3	1 640	3 650	168 000	370 000
279.400 11.0000	482.600 19.0000	177.800 7.0000	177.800 7.0000	6.0	4.8	2 380	4 650	243 000	475 000
279.578 11.0070	381.000 15.0000	88.900 3.5000	111.125 4.3750	3.3	6.4	825	1 800	84 000	184 000
290	450	180	180	2.5	4	1 970	4 250	201 000	435 000
300	500 520	200 180	200 210	5 4	5 4	2 500 2 310	6 050 4 500	255 000 236 000	615 000 460 000
304.800 12.0000	499.948 19.6830	158.750 6.2500	203.200 8.0000	3.3	6.4	2 040	4 050	208 000	415 000
305.079	500	200	200	6.4	4.8	2 500	6 050	255 000	615 000
320	620	264	296	6	5	3 900	7 550	395 000	770 000
330	650	248	248	6	7.5	3 350	6 100	340 000	620 000
350	618	200	200	6	6	2 880	5 450	293 000	555 000
360	550	148	148	6	5	1 940	3 900	198 000	400 000
400	650	200	200	6	6	2 870	6 300	293 000	640 000
460	618	150	150	5	4	1 600	4 150	163 000	420 000
500	720	185	218	6	6	2 950	6 800	300 000	695 000
540	860	256	256	7.5	7.5	5 400	12 100	555 000	1 240 000

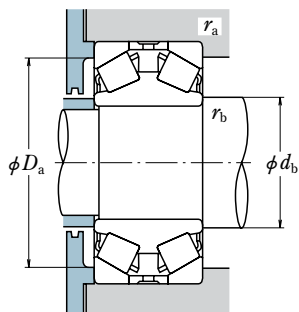

Dynamic Equivalent Load

$$P = XF_r + YF_a$$

$F_a/F_r \leq e$		$F_a/F_r > e$	
X	Y	X	Y
1	Y_3	0.67	Y_2

Static Equivalent Load

$$P_0 = F_r + Y_0 F_a$$

The values of e , Y_2 , Y_3 , and Y_0 are given in the table below.

Bearing Numbers	Abutment and Fillet Dimensions (mm)				Constant e	Axial Load Factors			Mass (kg) approx.
	d_b	D_a	r_a max.	r_b max.		Y_2	Y_3	Y_0	
* EE435103D / 435165+K	282	378	3.3	3.3	0.61	1.7	1.1	1.1	85.2
* 279KDH4851+K	310	433	4.8	6.0	0.70	1.4	0.97	0.94	139
* 89111D / 89150+K	296	354	6.4	3.3	0.58	1.7	1.2	1.1	32.6
290KDH4501+K	308	408	3	2	0.64	1.6	1.1	1.0	103
300KDH5001+K	332	447	4	4	0.70	1.4	0.97	0.94	167
300KDH5201A+K	326	461	3	3	1.2	0.85	0.57	0.56	178
* 304KDH4951+K	327	444	6.4	3.3	1.2	0.85	0.57	0.56	145
305KDH5001A+K	335	447	4.8	6.4	0.70	1.4	0.97	0.94	162
320KDH6201+K	361	542	4	5	0.94	1.1	0.72	0.70	399
330KDH6501+K	379	572	6	5	1.3	0.80	0.54	0.52	369
350KDH6102	395	556	5	5	0.87	1.2	0.78	0.76	236
360KDH5501+K	389	506	4	5	0.70	1.4	0.97	0.94	123
400KDH6503+K	439	586	5	5	1.1	0.96	0.64	0.63	264
460KDH6101A+K	484	575	3	4	1.1	0.96	0.64	0.63	117
500KDH7201+K	532	664	5	5	0.70	1.4	0.97	0.95	262
540KDH8601+K	591	786	6	6	0.70	1.4	0.97	0.94	575

Note * Bearings marked * are inch design.



SPHERICAL ROLLER BEARINGS

Spherical Roller Bearings

Cylindrical Bores, Tapered Bores

Bore Diameter 100 – 1590mm B290

Design, Types, and Features

These bearings have two rows of barrel-shaped rollers between the inner ring, which has two raceways, and the outer ring that has one spherical raceway. Since they have self-aligning capability, if there is deflection of the shaft or housing or misalignment of their axes, it is automatically corrected so excessive force is not applied to the bearings.

Some bearings have tapered bores and may be mounted directly on tapered shafts or cylindrical shafts using adapters or withdrawal sleeves.

As shown in Table 1, various types of standard spherical roller bearings are available.

Table 1 Types and Features of Spherical Roller Bearings

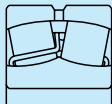
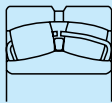
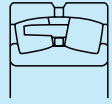
Types	Cross Section	Inner Ring	Rollers	Cages	Guide Ring	Features
EA		No central integral rib or side ribs	Symmetrical	Two piece pressed steel	None	Higher load capacity Lower torque
C,CD		No central integral rib or side ribs	Symmetrical	Two piece pressed steel	Yes	Higher load capacity
CA		Side ribs	Symmetrical	One piece machined brass	Yes	Higher load capacity

All spherical roller bearings (the bearing numbers are suffixed with E4) have an oil groove and holes in the outer ring to supply lubricant.

To use bearings with oil grooves and holes, it is recommended to provide an oil groove in the housing bore, since the depth of the groove in the bearing is limited. The number and dimensions of the oil groove and holes are shown in Tables 2 and 3.

When bearings with a hole for a locking pin to prevent outer ring rotation are required, please inform NSK.

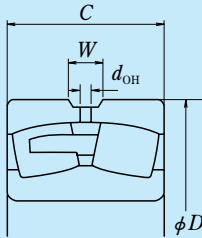

Table 2 Dimensions of Oil Grooves and Holes

Nominal Outer Ring Width <i>c</i>		Oil Groove Width <i>W</i>	Units:mm	
over	incl		Hole Diameter	
			<i>d_{OH}</i>	
40	50	7	4	
50	65	8	5	
65	80	10	6	
80	100	12	8	
100	120	15	10	
120	160	20	12	
160	200	25	15	
200	250	30	20	
250	315	35	20	
315	400	40	25	
400	—	40	25	

Table 3 Number of Oil Holes

Nominal Outside Dia <i>D</i> (mm)		Number of Holes
over	incl	
—	180	4
180	250	6
250	315	6
315	400	6
400	500	6
500	630	8
630	800	8
800	1000	8
1000	1250	8
1250	1600	8
1600	2000	8

Tolerances and

Running Accuracy.....Table 2.2 (Pages A16 to A19)

Recommendes Fits.....Table 3.2 (Page A35)

Table 3.4 (Page A36)

Internal Clearance.....Table 3.12 (Page A42)

Permissible Misalignment

The permissible misalignment of spherical roller bearings varies depending on the size and load, but it is approximately 1° to 2.5° with average loads.

Precautions for Use of Spherical Roller Bearings

If the load on spherical roller bearings becomes too small, or if the ratio of the axial and radial loads exceeds 'e' (e is listed in the bearing tables) during operation, slippage between the rollers and raceways occurs, which may result in smearing. Especially with large bearings since the weight of the rollers and cage is high. If such load conditions are expected, please consult with NSK for selection of the bearings.

SPHERICAL ROLLER BEARINGS

Bore Diameter 100 – 150 mm

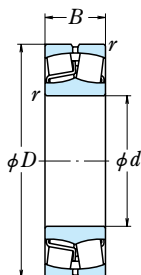

Cylindrical Bore

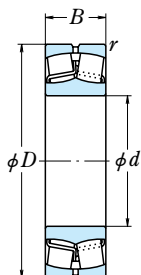

Tapered Bore

d	Boundary Dimensions (mm)			Basic Load Ratings			
	D	B	r min.	C_r (kN)	C_{0r}	C_r (kgf)	C_{0r}
100	180	46	2.1	455	490	46 500	50 000
	180	60.3	2.1	420	605	42 500	61 500
	215	73	3	860	930	88 000	94 500
110	170	45	2	293	465	29 900	47 500
	180	56	2	385	630	39 500	64 000
	180	69	2	460	750	47 000	76 500
	200	53	2.1	605	645	61 500	66 000
	200	69.8	2.1	515	760	52 500	77 500
120	240	80	3	1 030	1 120	105 000	115 000
	180	46	2	315	525	32 000	53 500
	180	60	2	395	705	40 500	72 000
	200	62	2	465	720	47 500	73 500
	200	80	2	575	950	58 500	96 500
	215	58	2.1	685	765	70 000	78 000
	215	76	2.1	630	970	64 500	99 000
	260	86	3	1 190	1 320	122 000	134 000
130	200	52	2	400	655	40 500	67 000
	200	69	2	495	865	50 500	88 000
	210	64	2	505	825	51 500	84 500
	210	80	2	590	1 010	60 000	103 000
	230	64	3	820	940	83 500	96 000
	230	80	3	700	1 080	71 500	110 000
	280	93	4	995	1 350	101 000	137 000
140	210	53	2	420	715	43 000	73 000
	210	69	2	525	945	53 500	96 500
	225	68	2.1	580	945	59 000	96 500
	225	85	2.1	670	1 160	68 500	118 000
	250	68	3	645	930	65 500	95 000
	250	88	3	835	1 300	85 000	133 000
	300	102	4	1 160	1 590	118 000	162 000
150	225	56	2.1	470	815	48 000	83 000
	225	75	2.1	590	1 090	60 500	111 000
	250	80	2.1	725	1 180	74 000	121 000
	250	100	2.1	890	1 530	91 000	156 000
	270	73	3	765	1 120	78 000	114 000
	270	96	3	975	1 560	99 500	159 000
	320	108	4	1 220	1 690	125 000	172 000

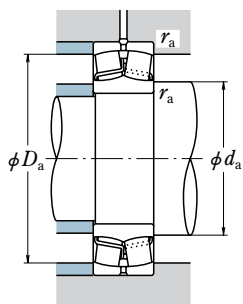

Dynamic Equivalent Load

$$P = XF_r + YF_a$$

$F_a/F_r \leq e$		$F_a/F_r > e$	
X	Y	X	Y
1	Y_3	0.67	Y_2

Static Equivalent Load

$$P_0 = F_r + Y_0 F_a$$

The values of e , Y_2 , Y_3 , and Y_0 are given in the table below.

Bearing Numbers		Abutment and Fillet Dimensions (mm)			Constant e	Axial Load Factors			Mass (kg) approx.
Cylindrical Bore	Tapered Bore ⁽¹⁾	d_a	D_a	r_a max.		Y_2	Y_3	Y_0	
22220EAE4	22220EAKE4	117	164	2	0.24	4.3	2.9	2.8	4.84
23220CE4	23220CKE4	117	164	2	0.32	3.2	2.1	2.1	6.5
22320EAE4	22320EAKE4	119	196	2.5	0.33	3.0	2.0	2.0	12.7
23022CDE4	23022CDKE4	123	156	2	0.24	4.2	2.8	2.8	3.7
23122CE4	23122CKE4	125	166	2	0.28	3.5	2.4	2.3	5.6
24122CE4	24122CK30E4	122	166	2	0.36	2.8	1.9	1.8	6.7
22222EAE4	22222EAKE4	127	184	2	0.25	4.0	2.7	2.6	6.99
23222CE4	23222CKE4	127	184	2	0.34	3.0	2.0	1.9	9.4
22322EAE4	22322EAKE4	129	221	2.5	0.33	3.1	2.1	2.0	17.6
23024CDE4	23024CDKE4	133	166	2	0.22	4.5	3.0	2.9	4.0
24024CE4	24024CK30E4	130	166	2	0.32	3.2	2.1	2.1	5.2
23124CE4	23124CKE4	136	186	2	0.29	3.5	2.4	2.3	7.7
24124CE4	24124CK30E4	136	186	2	0.37	2.7	1.8	1.8	9.9
22224EAE4	22224EAKE4	138	198	2	0.25	3.9	2.7	2.6	8.8
23224CE4	23224CKE4	138	198	2	0.34	2.9	2.0	1.9	12
22324EAE4	22324EAKE4	140	241	2.5	0.32	3.1	2.1	2.0	22.2
23026CDE4	23026CDKE4	146	186	2	0.23	4.3	2.9	2.8	5.9
24026CE4	24026CK30E4	142	186	2	0.31	3.2	2.2	2.1	7.7
23126CE4	23126CKE4	146	196	2	0.28	3.6	2.4	2.4	8.6
24126CE4	24126CK30E4	146	196	2	0.35	2.9	1.9	1.9	10.6
22226EAE4	22226EAKE4	150	211	2.5	0.26	3.8	2.6	2.5	11
23226CE4	23226CKE4	150	211	2.5	0.34	2.9	2.0	1.9	14.2
22326CE4	22326CKE4	154	256	3	0.34	2.9	2.0	1.9	27.9
23028CDE4	23028CDKE4	156	196	2	0.22	4.5	3.0	2.9	6.4
24028CE4	24028CK30E4	153	196	2	0.29	3.4	2.3	2.2	8.2
23128CE4	23128CKE4	157	208	2	0.28	3.6	2.4	2.3	10.4
24128CE4	24128CK30E4	155	208	2	0.35	2.9	1.9	1.9	12.8
22228CDE4	22228CDKE4	161	231	2.5	0.25	4.0	2.7	2.6	14.4
23228CE4	23228CKE4	161	231	2.5	0.35	2.9	1.9	1.9	18.6
22328CE4	22328CKE4	165	276	3	0.35	2.9	1.9	1.9	35.2
23030CDE4	23030CDKE4	167	208	2	0.22	4.6	3.1	3.0	7.8
24030CE4	24030CK30E4	164	208	2	0.30	3.4	2.3	2.2	10.4
23130CE4	23130CKE4	169	233	2	0.30	3.4	2.3	2.2	15.7
24130CE4	24130CK30E4	169	233	2	0.38	2.6	1.8	1.7	19.6
22230CDE4	22230CDKE4	171	250	2.5	0.26	3.9	2.6	2.5	18.3
23230CE4	23230CKE4	171	250	2.5	0.35	2.9	1.9	1.9	24
22330CAE4	22330CAKE4	175	295	3	0.35	2.9	1.9	1.9	41.2

Note ⁽¹⁾ The suffix K or K30 represents bearings with tapered bores (taper 1 : 12 or 1 : 30).

Remarks An oil groove and holes are standard for the E4 type.

SPHERICAL ROLLER BEARINGS

Bore Diameter 160 – 190 mm

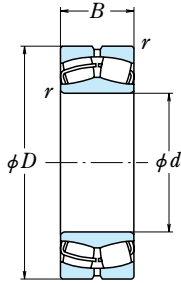

Cylindrical Bore

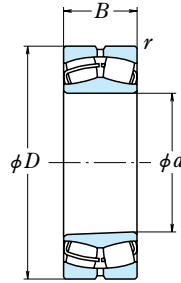

Tapered Bore

Boundary Dimensions (mm)				Basic Load Ratings			
d	D	B	r min.	(kN)		(kgf)	
				C_r	C_{0r}	C_r	C_{0r}
160	220	45	2	360	675	37 000	69 000
	240	60	2.1	540	955	55 000	97 500
	240	80	2.1	680	1 260	69 000	128 000
	270	86	2.1	855	1 400	87 000	143 000
	270	109	2.1	1 040	1 760	106 000	179 000
	290	80	3	910	1 320	93 000	135 000
	290	104	3	1 100	1 770	112 000	180 000
	340	114	4	1 360	1 900	139 000	193 000
170	230	45	2	350	660	35 500	67 500
	260	67	2.1	640	1 090	65 000	112 000
	260	90	2.1	825	1 520	84 000	155 000
	280	88	2.1	940	1 570	96 000	160 000
	280	109	2.1	1 080	1 860	110 000	190 000
	310	86	4	990	1 500	101 000	153 000
	310	110	4	1 200	1 910	122 000	195 000
	360	120	4	1 580	2 110	161 000	215 000
180	250	52	2	470	890	48 000	90 500
	280	74	2.1	750	1 270	76 000	129 000
	280	100	2.1	965	1 750	98 500	178 000
	300	96	3	1 050	1 760	108 000	180 000
	300	118	3	1 190	2 040	121 000	208 000
	320	86	4	1 020	1 540	104 000	157 000
	320	112	4	1 300	2 110	133 000	215 000
	380	126	4	1 740	2 340	177 000	238 000
190	260	52	2	460	875	47 000	89 500
	290	75	2.1	775	1 350	79 000	138 000
	290	100	2.1	975	1 840	99 500	186 000
	320	104	3	1 190	2 020	121 000	206 000
	320	128	3	1 370	2 330	140 000	238 000
	340	92	4	1 140	1 730	116 000	176 000
	340	120	4	1 440	2 350	147 000	240 000
	400	132	5	1 890	2 590	193 000	264 000

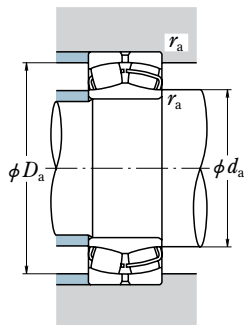

Dynamic Equivalent Load

$$P = XF_r + YF_a$$

$F_a/F_r \leq e$		$F_a/F_r > e$	
X	Y	X	Y
1	Y_3	0.67	Y_2

Static Equivalent Load

$$P_0 = F_r + Y_0 F_a$$

The values of e , Y_2 , Y_3 , and Y_0 are given in the table below.

Bearing Numbers		Abutment and Fillet Dimensions (mm)			Constant e	Axial Load Factors			Mass (kg) approx.
Cylindrical Bore	Tapered Bore ⁽¹⁾	d_a	D_a	r_a max.		Y_2	Y_3	Y_0	
23932CAE4	23932CAKE4	177	205	2	0.18	5.6	3.8	3.7	4.9
23032CDE4	23032CDKE4	179	223	2	0.22	4.5	3.0	2.9	9.5
24032CE4	24032CK30E4	176	223	2	0.30	3.4	2.3	2.2	12.6
23132CE4	23132CKE4	179	252	2	0.30	3.4	2.3	2.2	20.1
24132CE4	24132CK30E4	179	252	2	0.39	2.6	1.7	1.7	25.2
22232CDE4	22232CDKE4	181	270	2.5	0.26	3.8	2.6	2.5	23
23232CE4	23232CKE4	181	270	2.5	0.34	2.9	2.0	1.9	30.2
22332CAE4	22332CAKE4	186	315	3	0.35	2.9	1.9	1.9	49
23934BCAE4	23934BCAKE4	188	215	2	0.17	5.8	3.9	3.8	5.3
23034CDE4	23034CDKE4	190	243	2	0.23	4.3	2.9	2.8	12.9
24034CE4	24034CK30E4	187	243	2	0.31	3.2	2.2	2.1	17.2
23134CE4	23134CKE4	190	262	2	0.29	3.5	2.3	2.3	21.6
24134CE4	24134CK30E4	190	262	2	0.37	2.7	1.8	1.8	26.4
22234CDE4	22234CDKE4	196	286	3	0.26	3.8	2.6	2.5	28.6
23234CE4	23234CKE4	196	286	3	0.34	2.9	2.0	1.9	36.1
22334CAE4	22334CAKE4	196	335	3	0.35	2.9	1.9	1.9	57.5
23936CAE4	23936CAKE4	198	235	2	0.18	5.5	3.7	3.6	7.5
23036CDE4	23036CDKE4	200	262	2	0.24	4.2	2.8	2.8	16.9
24036CE4	24036CK30E4	200	262	2	0.32	3.1	2.1	2.0	22.5
23136CE4	23136CKE4	202	280	2.5	0.30	3.4	2.3	2.2	27.3
24136CE4	24136CK30E4	202	280	2.5	0.37	2.7	1.8	1.8	32.9
22236CDE4	22236CDKE4	206	295	3	0.26	3.9	2.6	2.6	29.9
23236CE4	23236CKE4	206	295	3	0.33	3.0	2.0	2.0	38.6
22336CAE4	22336CAKE4	206	354	3	0.34	2.9	2.0	1.9	66.4
23938CAE4	23938CAKE4	208	245	2	0.18	5.7	3.8	3.7	7.9
23038CDE4	23038CDKE4	211	272	2	0.24	4.2	2.8	2.8	17.5
24038CE4	24038CK30E4	209	272	2	0.31	3.2	2.2	2.1	23.7
23138CE4	23138CKE4	213	299	2.5	0.31	3.3	2.2	2.2	34.2
24138CE4	24138CK30E4	210	299	2.5	0.40	2.5	1.7	1.6	41.1
22238CAE4	22238CAKE4	217	315	3	0.26	3.8	2.6	2.5	35.2
23238CE4	23238CKE4	217	315	3	0.35	2.9	1.9	1.9	47.3
22338CAE4	22338CAKE4	221	370	4	0.34	2.9	2.0	1.9	77.4

Note ⁽¹⁾ The suffix K or K30 represents bearings with tapered bores (taper 1 : 12 or 1 : 30).

SPHERICAL ROLLER BEARINGS

Bore Diameter 200 – 260 mm

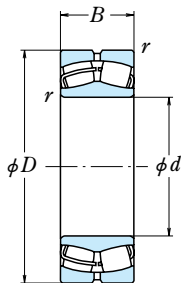

Cylindrical Bore

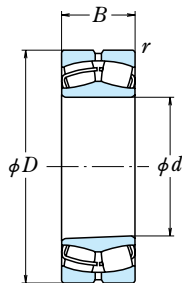

Tapered Bore

d	Boundary Dimensions (mm)			Basic Load Ratings			
	D	B	r min.	C_r (kN)	C_{0r}	C_r (kgf)	C_{0r}
200	280	60	2.1	570	1 060	58 000	108 000
	310	82	2.1	940	1 700	96 000	174 000
	310	109	2.1	1 140	2 120	116 000	216 000
	340	112	3	1 360	2 330	139 000	238 000
	340	140	3	1 570	2 670	160 000	272 000
	360	98	4	1 300	2 010	133 000	204 000
	360	128	4	1 660	2 750	169 000	281 000
	420	138	5	2 000	2 990	204 000	305 000
220	300	60	2.1	625	1 240	64 000	126 000
	340	90	3	1 090	1 980	111 000	202 000
	340	118	3	1 360	2 600	138 000	265 000
	370	120	4	1 570	2 710	160 000	276 000
	370	150	4	1 800	3 200	183 000	325 000
	400	108	4	1 570	2 430	160 000	247 000
	400	144	4	2 020	3 400	206 000	350 000
	460	145	5	2 350	3 400	240 000	345 000
240	320	60	2.1	635	1 300	65 000	133 000
	360	92	3	1 160	2 140	118 000	218 000
	360	118	3	1 390	2 730	141 000	278 000
	400	128	4	1 790	3 100	182 000	320 000
	400	160	4	2 130	3 800	217 000	385 000
	440	120	4	1 870	2 890	191 000	294 000
	440	160	4	2 440	4 050	249 000	415 000
	500	155	5	2 600	3 800	265 000	385 000
260	360	75	2.1	930	1 870	95 000	191 000
	400	104	4	1 430	2 580	145 000	263 000
	400	140	4	1 810	3 500	185 000	360 000
	440	144	4	2 160	3 750	221 000	385 000
	440	180	4	2 560	4 700	261 000	480 000
	480	130	5	2 180	3 400	222 000	345 000
	480	174	5	2 740	4 550	279 000	460 000
	540	165	6	3 100	4 600	320 000	470 000

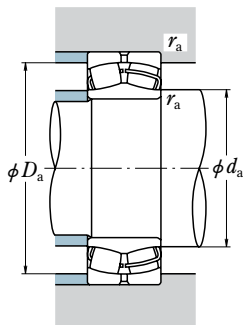

Dynamic Equivalent Load

$$P = XF_r + YF_a$$

$F_a/F_r \leq e$		$F_a/F_r > e$	
X	Y	X	Y
1	Y_3	0.67	Y_2

Static Equivalent Load

$$P_0 = F_r + Y_0 F_a$$

The values of e , Y_2 , Y_3 , and Y_0 are given in the table below.

Bearing Numbers		Abutment and Fillet Dimensions (mm)			Constant e	Axial Load Factors			Mass (kg) approx.
Cylindrical Bore	Tapered Bore ⁽¹⁾	d_a	D_a	r_a max.		Y_2	Y_3	Y_0	
23940CAE4	23940CAKE4	221	262	2	0.20	5.1	3.4	3.3	10.9
23040CAE4	23040CAKE4	221	292	2	0.25	4.0	2.7	2.6	22.2
24040CE4	24040CK30E4	221	292	2	0.32	3.1	2.1	2.0	30.1
23140CE4	23140CKE4	223	319	2.5	0.31	3.2	2.2	2.1	42.3
24140CE4	24140CK30E4	223	319	2.5	0.39	2.6	1.8	1.7	50.9
22240CAE4	22240CAKE4	227	335	3	0.26	3.8	2.6	2.5	42.4
23240CE4	23240CKE4	227	335	3	0.34	2.9	2.0	1.9	56.6
22340CAE4	22340CAKE4	231	390	4	0.34	2.9	2.0	1.9	91.7
23944CAE4	23944CAKE4	242	282	2	0.18	5.7	3.8	3.7	12.1
23044CAE4	23044CAKE4	244	319	2.5	0.24	4.1	2.8	2.7	29.4
24044CE4	24044CK30E4	244	319	2.5	0.31	3.2	2.1	2.1	39.4
23144CE4	23144CKE4	248	344	3	0.30	3.3	2.2	2.2	52.6
24144CE4	24144CK30E4	248	344	3	0.39	2.6	1.7	1.7	66.7
22244CAE4	22244CAKE4	248	374	3	0.27	3.7	2.5	2.4	58.6
23244CE4	23244CKE4	248	374	3	0.35	2.9	1.9	1.9	79.7
22344CAE4	22344CAKE4	252	429	4	0.33	3.0	2.0	2.0	115
23948CAE4	23948CAKE4	263	301	2	0.17	6.0	4.0	3.9	13.1
23048CAE4	23048CAKE4	265	339	2.5	0.24	4.2	2.8	2.7	32.3
24048CE4	24048CK30E4	265	339	2.5	0.29	3.4	2.3	2.2	42
23148CE4	23148CKE4	269	374	3	0.30	3.3	2.2	2.2	64.4
24148CE4	24148CK30E4	267	374	3	0.38	2.7	1.8	1.8	79
22248CAE4	22248CAKE4	269	413	3	0.27	3.7	2.5	2.4	79.7
23248CAE4	23248CAKE4	269	413	3	0.37	2.7	1.8	1.8	105
22348CAE4	22348CAKE4	273	468	4	0.32	3.2	2.1	2.1	146
23952CAE4	23952CAKE4	283	341	2	0.19	5.4	3.6	3.5	22.8
23052CAE4	23052CAKE4	290	374	3	0.25	4.1	2.7	2.7	46.2
24052CAE4	24052CAK30E4	290	374	3	0.32	3.1	2.1	2.1	62
23152CAE4	23152CAKE4	290	413	3	0.32	3.2	2.1	2.1	87.6
24152CAE4	24152CAK30E4	290	413	3	0.39	2.6	1.7	1.7	108
22252CAE4	22252CAKE4	294	448	4	0.27	3.7	2.5	2.5	103
23252CAE4	23252CAKE4	294	448	4	0.37	2.7	1.8	1.8	135
22352CAE4	22352CAKE4	300	501	5	0.32	3.2	2.1	2.1	179

Note ⁽¹⁾ The suffix K or K30 represents bearings with tapered bores (taper 1 : 12 or 1 : 30).

SPHERICAL ROLLER BEARINGS

Bore Diameter 280 – 360 mm

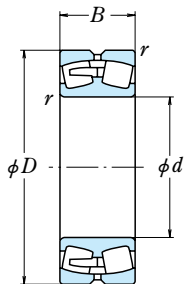

Cylindrical Bore

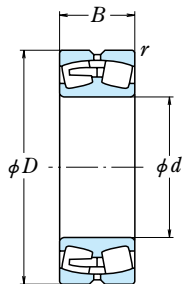

Tapered Bore

<i>d</i>	Boundary Dimensions (mm)			Basic Load Ratings				
	<i>D</i>	<i>B</i>	<i>r</i> min.	<i>C_r</i> (kN)	<i>C_{0r}</i>	<i>C_r</i> (kgf)	<i>C_{0r}</i>	
280	380	75	2.1	925	1 950	94 500	199 000	
	420	106	4	1 540	2 950	157 000	300 000	
	420	140	4	1 880	3 800	191 000	385 000	
	460	146	5	2 230	4 000	228 000	410 000	
	460	180	5	2 640	5 000	269 000	505 000	
	500	130	5	2 280	3 650	233 000	370 000	
	500	176	5	2 880	4 900	294 000	500 000	
	580	175	6	3 500	5 150	355 000	525 000	
300	420	90	3	1 230	2 490	125 000	254 000	
	460	118	4	1 920	3 700	196 000	375 000	
	460	160	4	2 310	4 600	235 000	470 000	
	500	160	5	2 670	4 800	273 000	490 000	
	500	200	5	3 100	5 800	315 000	595 000	
	540	140	5	2 610	4 250	266 000	430 000	
	540	192	5	3 400	5 900	350 000	600 000	
	620	185	7.5	3 950	5 900	400 000	600 000	
320	440	90	3	1 300	2 750	132 000	281 000	
	480	121	4	1 960	3 850	200 000	395 000	
	480	160	4	2 440	5 050	249 000	515 000	
	540	176	5	3 050	5 500	315 000	560 000	
	540	218	5	3 550	6 650	360 000	675 000	
	580	150	5	2 990	4 850	305 000	495 000	
	580	208	5	3 900	6 900	395 000	700 000	
	580	243	5	4 250	7 900	430 000	810 000	
340	460	90	3	1 330	2 840	136 000	289 000	
	520	133	5	2 280	4 400	232 000	445 000	
	520	180	5	2 920	6 050	298 000	615 000	
	580	190	5	3 600	6 600	370 000	670 000	
	580	243	5	4 250	7 900	430 000	810 000	
	620	224	6	4 400	7 800	450 000	795 000	
	360	480	90	3	1 390	3 050	142 000	315 000
		540	134	5	2 390	4 700	244 000	480 000
540		180	5	2 930	6 100	299 000	625 000	
600		192	5	3 800	7 100	390 000	725 000	
600		243	5	4 200	8 000	430 000	815 000	
650		232	6	4 800	8 550	490 000	870 000	

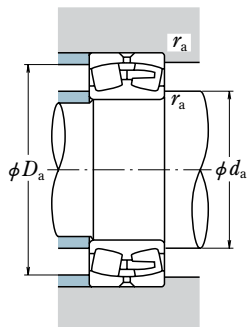

Dynamic Equivalent Load

$$P = XF_r + YF_a$$

$F_a/F_r \leq e$		$F_a/F_r > e$	
X	Y	X	Y
1	Y_3	0.67	Y_2

Static Equivalent Load

$$P_0 = F_r + Y_0 F_a$$

The values of e , Y_2 , Y_3 , and Y_0 are given in the table below.

Bearing Numbers		Abutment and Fillet Dimensions (mm)			Constant e	Axial Load Factors			Mass (kg) approx.
Cylindrical Bore	Tapered Bore(*)	d_a	D_a	r_a max.		Y_2	Y_3	Y_0	
23956CAE4	23956CAKE4	304	360	2	0.18	5.7	3.9	3.8	24.3
23056CAE4	23056CAKE4	310	393	3	0.24	4.2	2.8	2.7	50.1
24056CAE4	24056CAK30E4	310	393	3	0.31	3.3	2.2	2.2	65.8
23156CAE4	23156CAKE4	315	429	4	0.30	3.3	2.2	2.2	93.6
24156CAE4	24156CAK30E4	315	429	4	0.37	2.7	1.8	1.8	114
22256CAE4	22256CAKE4	315	468	4	0.25	4.0	2.7	2.6	109
23256CAE4	23256CAKE4	315	468	4	0.35	2.9	1.9	1.9	145
22356CAE4	22356CAKE4	321	540	5	0.31	3.2	2.1	2.1	219
23960CAE4	23960CAKE4	327	397	2.5	0.19	5.2	3.5	3.4	37.9
23060CAE4	23060CAKE4	331	433	3	0.24	4.2	2.8	2.7	70
24060CAE4	24060CAK30E4	331	433	3	0.32	3.1	2.1	2.0	92.9
23160CAE4	23160CAKE4	335	468	4	0.31	3.3	2.2	2.2	124
24160CAE4	24160CAK30E4	335	468	4	0.38	2.6	1.8	1.7	151
22260CAE4	22260CAKE4	335	507	4	0.25	4.0	2.7	2.6	138
23260CAE4	23260CAKE4	335	507	4	0.35	2.9	1.9	1.9	188
22360CAE4	22360CAKE4	350	572	6	0.31	3.3	2.2	2.2	264
23964CAE4	23964CAKE4	348	417	2.5	0.18	5.5	3.7	3.6	40.9
23064CAE4	23064CAKE4	352	452	3	0.24	4.2	2.8	2.8	74.9
24064CAE4	24064CAK30E4	352	452	3	0.31	3.3	2.2	2.2	99
23164CAE4	23164CAKE4	356	507	4	0.31	3.2	2.1	2.1	161
24164CAE4	24164CAK30E4	356	507	4	0.39	2.6	1.7	1.7	194
22264CAE4	22264CAKE4	356	546	4	0.26	3.9	2.6	2.6	173
23264CAE4	23264CAKE4	356	546	4	0.36	2.8	1.9	1.8	237
23968CAE4	23968CAKE4	369	437	2.5	0.18	5.7	3.8	3.7	42.1
23068CAE4	23068CAKE4	377	488	4	0.24	4.2	2.8	2.8	100
24068CAE4	24068CAK30E4	377	488	4	0.32	3.2	2.1	2.1	134
23168CAE4	23168CAKE4	377	546	4	0.31	3.2	2.1	2.1	205
24168CAE4	24168CAK30E4	377	546	4	0.40	2.5	1.7	1.7	255
23268CAE4	23268CAKE4	383	580	5	0.36	2.8	1.9	1.8	292
23972CAE4	23972CAKE4	389	456	2.5	0.17	6.0	4.1	4.0	44.4
23072CAE4	23072CAKE4	398	507	4	0.24	4.2	2.8	2.8	105
24072CAE4	24072CAK30E4	398	507	4	0.32	3.2	2.1	2.1	138
23172CAE4	23172CAKE4	398	566	4	0.31	3.2	2.2	2.1	215
24172CAE4	24172CAK30E4	398	566	4	0.40	2.5	1.7	1.7	262
23272CAE4	23272CAKE4	404	609	5	0.36	2.8	1.9	1.8	330

Note (*) The suffix K or K30 represents bearings with tapered bores (taper 1 : 12 or 1 : 30).

SPHERICAL ROLLER BEARINGS

Bore Diameter 380 – 480 mm

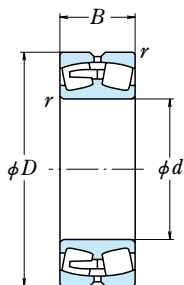

Cylindrical Bore

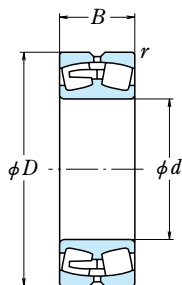

Tapered Bore

<i>d</i>	Boundary Dimensions (mm)			Basic Load Ratings			
	<i>D</i>	<i>B</i>	<i>r</i> min.	<i>C_r</i> (kN)	<i>C_{0r}</i>	<i>C_r</i> (kgf)	<i>C_{0r}</i>
380	520	106	4	1 870	4 100	190 000	420 000
	560	135	5	2 500	5 100	255 000	520 000
	560	180	5	3 050	6 600	315 000	670 000
	620	194	5	4 000	7 600	405 000	775 000
	620	243	5	4 350	8 450	440 000	865 000
400	680	240	6	5 150	9 200	525 000	940 000
	540	106	4	1 890	4 250	193 000	435 000
	600	148	5	2 970	5 900	305 000	605 000
	600	200	5	3 600	7 600	370 000	775 000
	650	200	6	4 150	7 900	420 000	805 000
420	650	250	6	4 950	10 100	505 000	1 030 000
	720	256	6	5 800	10 400	590 000	1 060 000
	560	106	4	1 870	4 250	191 000	430 000
	620	150	5	2 910	5 850	297 000	595 000
	620	200	5	3 750	8 100	380 000	825 000
440	700	224	6	5 000	9 400	510 000	960 000
	700	280	6	6 000	12 000	610 000	1 220 000
	760	272	7.5	6 450	11 700	660 000	1 190 000
	600	118	4	2 190	4 800	223 000	490 000
	650	157	6	3 150	6 350	320 000	645 000
460	650	212	6	4 150	9 100	425 000	930 000
	720	226	6	5 300	10 300	540 000	1 060 000
	720	280	6	6 000	12 100	610 000	1 230 000
	790	280	7.5	6 900	12 800	705 000	1 300 000
	620	118	4	2 220	4 950	227 000	505 000
480	680	163	6	3 450	7 100	355 000	725 000
	680	218	6	4 500	9 950	460 000	1 010 000
	760	240	7.5	5 700	10 900	580 000	1 110 000
	760	300	7.5	6 300	12 400	640 000	1 270 000
	830	296	7.5	7 350	13 700	750 000	1 400 000
480	650	128	5	2 580	5 850	263 000	595 000
	700	165	6	3 800	7 950	385 000	810 000
	700	218	6	4 600	10 200	470 000	1 040 000
	790	248	7.5	6 050	11 700	620 000	1 200 000
	790	308	7.5	7 150	14 600	730 000	1 490 000
	870	310	7.5	7 850	14 400	805 000	1 470 000

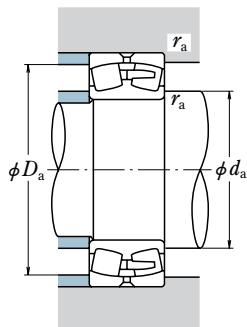

Dynamic Equivalent Load

$$P = XF_r + YF_a$$

$F_a/F_r \leq e$		$F_a/F_r > e$	
X	Y	X	Y
1	Y_3	0.67	Y_2

Static Equivalent Load

$$P_0 = F_r + Y_0 F_a$$

The values of e , Y_2 , Y_3 , and Y_0 are given in the table below.

Bearing Numbers		Abutment and Fillet Dimensions (mm)			Constant e	Axial Load Factors			Mass (kg) approx.
Cylindrical Bore	Tapered Bore(*)	d_a	D_a	r_a max.		Y_2	Y_3	Y_0	
23976CAE4	23976CAKE4	414	491	3	0.18	5.5	3.7	3.6	64.9
23076CAE4	23076CAKE4	419	527	4	0.22	4.5	3.0	3.0	112
24076CAE4	24076CAK30E4	419	527	4	0.29	3.4	2.3	2.3	147
23176CAE4	23176CAKE4	419	586	4	0.30	3.3	2.2	2.2	227
24176CAE4	24176CAK30E4	419	586	4	0.38	2.6	1.8	1.7	273
23276CAE4	23276CAKE4	425	638	5	0.35	2.9	1.9	1.9	369
23980CAE4	23980CAKE4	435	511	3	0.18	5.7	3.9	3.8	68.6
23080CAE4	23080CAKE4	439	566	4	0.23	4.4	3.0	2.9	145
24080CAE4	24080CAK30E4	439	566	4	0.31	3.3	2.2	2.2	192
23180CAE4	23180CAKE4	446	609	5	0.29	3.4	2.3	2.3	256
24180CAE4	24180CAK30E4	446	609	5	0.37	2.7	1.8	1.8	314
23280CAE4	23280CAKE4	446	678	5	0.36	2.8	1.9	1.9	446
23984CAE4	23984CAKE4	456	531	3	0.17	6.0	4.0	3.9	71.1
23084CAE4	23084CAKE4	460	586	4	0.23	4.3	2.9	2.8	150
24084CAE4	24084CAK30E4	460	586	4	0.31	3.2	2.2	2.1	197
23184CAE4	23184CAKE4	466	658	5	0.31	3.3	2.2	2.2	338
24184CAE4	24184CAK30E4	466	658	5	0.38	2.6	1.8	1.7	418
23284CAE4	23284CAKE4	475	709	6	0.35	2.9	1.9	1.9	531
23988CAE4	23988CAKE4	477	570	3	0.18	5.7	3.9	3.8	96.3
23088CAE4	23088CAKE4	487	609	5	0.23	4.3	2.9	2.8	172
24088CAE4	24088CAK30E4	487	609	5	0.31	3.2	2.1	2.1	229
23188CAE4	23188CAKE4	487	678	5	0.30	3.3	2.2	2.2	358
24188CAE4	24188CAK30E4	487	678	5	0.37	2.7	1.8	1.8	431
23288CAE4	23288CAKE4	496	738	6	0.35	2.9	1.9	1.9	589
23992CAE4	23992CAKE4	498	589	3	0.17	5.9	4.0	3.9	99.6
23092CAE4	23092CAKE4	508	638	5	0.22	4.6	3.1	3.0	199
24092CAE4	24092CAK30E4	508	638	5	0.29	3.4	2.3	2.3	264
23192CAE4	23192CAKE4	516	709	6	0.31	3.3	2.2	2.2	420
24192CAE4	24192CAK30E4	516	709	6	0.39	2.6	1.7	1.7	509
23292CAE4	23292CAKE4	516	778	6	0.36	2.8	1.9	1.8	687
23996CAE4	23996CAKE4	523	615	4	0.18	5.7	3.8	3.7	120
23096CAE4	23096CAKE4	529	658	5	0.22	4.6	3.1	3.0	210
24096CAE4	24096CAK30E4	529	658	5	0.30	3.4	2.3	2.2	268
23196CAE4	23196CAKE4	537	738	6	0.31	3.3	2.2	2.2	472
24196CAE4	24196CAK30E4	537	738	6	0.39	2.6	1.7	1.7	567
23296CAE4	23296CAKE4	537	817	6	0.36	2.8	1.9	1.8	792

Note (*) The suffix K or K30 represents bearings with tapered bores (taper 1 : 12 or 1 : 30).

SPHERICAL ROLLER BEARINGS

Bore Diameter 500 – 630 mm

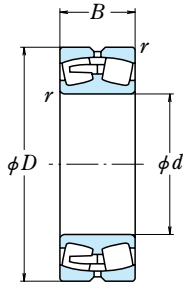

Cylindrical Bore

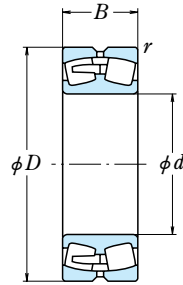

Tapered Bore

d	Boundary Dimensions (mm)			Basic Load Ratings			
	D	B	r min.	C_r (kN)	C_{0r}	C_r (kgf)	C_{0r}
500	670	128	5	2 460	5 550	250 000	565 000
	720	167	6	3 750	8 100	385 000	825 000
	720	218	6	4 450	9 900	450 000	1 010 000
	830	264	7.5	6 850	13 400	700 000	1 360 000
	830	325	7.5	8 000	16 000	815 000	1 630 000
	920	336	7.5	9 000	16 600	915 000	1 690 000
530	710	136	5	2 930	6 800	299 000	695 000
	780	185	6	4 400	9 200	450 000	940 000
	780	250	6	5 400	11 800	550 000	1 210 000
	870	272	7.5	7 150	14 100	730 000	1 440 000
	870	335	7.5	8 500	17 500	870 000	1 790 000
	980	355	9.5	10 100	18 800	1 030 000	1 920 000
540	820	195	6	5 000	10 700	510 000	1 090 000
560	750	140	5	3 100	7 250	320 000	740 000
	820	195	6	5 000	10 700	510 000	1 090 000
	820	258	6	5 950	13 300	605 000	1 360 000
	920	280	7.5	7 850	15 500	800 000	1 580 000
	920	355	7.5	9 400	19 600	960 000	2 000 000
	1 030	365	9.5	10 900	20 500	1 110 000	2 090 000
580	780	130	5	2 740	6 500	280 000	665 000
600	800	150	5	3 450	8 100	350 000	830 000
	820	175	6	3 800	8 850	385 000	900 000
	870	200	6	5 450	12 200	555 000	1 240 000
	870	272	6	6 600	15 100	675 000	1 540 000
	980	300	7.5	8 750	17 500	895 000	1 790 000
	980	375	7.5	9 850	20 300	1 000 000	2 070 000
630	1 090	388	9.5	12 700	24 900	1 300 000	2 540 000
	850	145	6	3 450	7 950	350 000	810 000
	850	165	6	4 000	9 350	405 000	950 000
	920	212	7.5	5 900	12 700	600 000	1 300 000
	920	290	7.5	7 550	17 400	770 000	1 770 000
	1 030	315	7.5	9 600	19 400	980 000	1 970 000
	1 030	400	7.5	11 300	23 900	1 160 000	2 440 000
	1 150	412	12	13 400	25 600	1 370 000	2 610 000

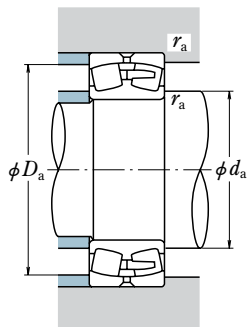

Dynamic Equivalent Load

$$P = XF_r + YF_a$$

$F_a/F_r \leq e$		$F_a/F_r > e$	
X	Y	X	Y
1	Y_3	0.67	Y_2

Static Equivalent Load

$$P_0 = F_r + Y_0 F_a$$

The values of e , Y_2 , Y_3 , and Y_0 are given in the table below.

Bearing Numbers		Abutment and Fillet Dimensions (mm)			Constant e	Axial Load Factors			Mass (kg) approx.
Cylindrical Bore	Tapered Bore ⁽¹⁾	d_a	D_a	r_a max.		Y_2	Y_3	Y_0	
239/500CAE4	239/500CAKE4	543	635	4	0.17	6.0	4.0	3.9	123
230/500CAE4	230/500CAKE4	550	678	5	0.21	4.8	3.2	3.1	219
240/500CAE4	240/500CAK30E4	550	678	5	0.30	3.4	2.3	2.2	276
231/500CAE4	231/500CAKE4	558	778	6	0.31	3.2	2.2	2.1	564
241/500CAE4	241/500CAK30E4	558	778	6	0.39	2.6	1.7	1.7	666
232/500CAE4	232/500CAKE4	558	866	6	0.38	2.7	1.8	1.8	969
239/530CAE4	239/530CAKE4	575	674	4	0.17	6.0	4.0	3.9	148
230/530CAE4	230/530CAKE4	581	736	5	0.22	4.6	3.1	3.0	296
240/530CAE4	240/530CAK30E4	581	736	5	0.31	3.3	2.2	2.2	390
231/530CAE4	231/530CAKE4	589	817	6	0.30	3.3	2.2	2.2	628
241/530CAE4	241/530CAK30E4	589	817	6	0.38	2.6	1.8	1.7	773
232/530CAE4	232/530CAKE4	597	917	8	0.38	2.7	1.8	1.7	1 170
540SL8261E4	—	591	776	5	0.22	4.5	3.0	2.9	377
239/560CAE4	239/560CAKE4	606	713	4	0.16	6.1	4.1	4.0	170
230/560CAE4	230/560CAKE4	612	776	5	0.22	4.5	3.0	2.9	344
240/560CAE4	240/560CAK30E4	612	776	5	0.30	3.3	2.2	2.2	440
231/560CAE4	231/560CAKE4	620	866	6	0.30	3.4	2.3	2.2	727
241/560CAE4	241/560CAK30E4	620	866	6	0.39	2.6	1.8	1.7	886
232/560CAE4	232/560CAKE4	629	966	8	0.36	2.8	1.9	1.8	1 320
580SL7861E4	—	627	742	4	0.15	6.9	4.6	4.5	178
239/600CAE4	239/600CAKE4	647	762	4	0.17	5.9	3.9	3.9	205
600SL8261E4	—	654	776	5	0.18	5.5	3.7	3.6	271
230/600CAE4	230/600CAKE4	654	825	5	0.21	4.8	3.3	3.2	389
240/600CAE4	240/600CAK30E4	654	825	5	0.30	3.3	2.2	2.2	529
231/600CAE4	231/600CAKE4	662	925	6	0.30	3.4	2.3	2.2	898
241/600CAE4	241/600CAK30E4	662	925	6	0.38	2.7	1.8	1.7	1 050
232/600CAE4	232/600CAKE4	670	1 025	8	0.36	2.8	1.9	1.8	1 590
—	630SL8561KE4	685	805	5	0.15	6.6	4.4	4.3	227
239/630CAE4	239/630CAKE4	685	805	5	0.18	5.6	3.8	3.7	259
230/630CAE4	230/630CAKE4	693	866	6	0.22	4.7	3.1	3.1	468
240/630CAE4	240/630CAK30E4	693	866	6	0.30	3.3	2.2	2.2	637
231/630CAE4	231/630CAKE4	693	974	6	0.30	3.4	2.3	2.2	1 040
241/630CAE4	241/630CAK30E4	693	974	6	0.38	2.7	1.8	1.7	1 250
232/630CAE4	232/630CAKE4	712	1 074	10	0.36	2.8	1.9	1.8	1 850

Note ⁽¹⁾ The suffix K or K30 represents bearings with tapered bores (taper 1 : 12 or 1 : 30).

SPHERICAL ROLLER BEARINGS

Bore Diameter 670 – 800 mm

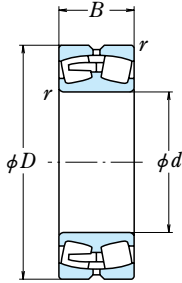

Cylindrical Bore

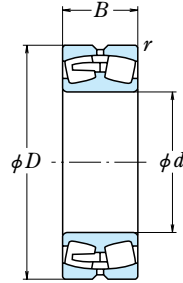

Tapered Bore

Boundary Dimensions (mm)				Basic Load Ratings (kN) (kgf)			
d	D	B	r min.	C_r	C_{0r}	C_r	C_{0r}
670	900	170	6	4 350	10 300	445 000	1 050 000
	920	170	6	4 350	10 300	445 000	1 050 000
	980	230	7.5	6 850	15 000	700 000	1 530 000
	980	308	7.5	8 450	19 500	860 000	1 990 000
	1 090	336	7.5	10 600	21 600	1 080 000	2 200 000
	1 090	412	7.5	12 400	26 500	1 270 000	2 700 000
	1 220	438	12	14 900	28 700	1 520 000	2 920 000
675	920	153	6	3 950	8 950	400 000	910 000
700	1 020	250	7.5	6 500	14 600	660 000	1 490 000
710	950	180	6	4 800	11 700	490 000	1 200 000
	1 030	236	7.5	7 100	15 800	725 000	1 610 000
	1 030	315	7.5	8 850	20 700	905 000	2 110 000
	1 150	345	9.5	11 800	24 500	1 210 000	2 500 000
	1 150	438	9.5	13 900	30 500	1 410 000	3 100 000
	1 280	450	12	15 700	30 500	1 600 000	3 100 000
730	980	170	6	4 600	10 700	470 000	1 100 000
750	1 000	185	6	5 250	12 800	535 000	1 310 000
	1 000	200	6	5 250	12 800	535 000	1 310 000
	1 090	250	7.5	7 750	17 200	790 000	1 750 000
	1 090	335	7.5	10 100	24 000	1 030 000	2 450 000
	1 220	365	9.5	13 100	27 300	1 330 000	2 790 000
	1 360	475	15	17 700	35 500	1 800 000	3 600 000
760	1 140	285	7.5	8 600	19 200	880 000	1 960 000
780	1 180	285	7.5	9 350	20 700	955 000	2 110 000
800	1 060	195	6	5 600	13 700	570 000	1 400 000
	1 150	258	7.5	8 350	19 100	850 000	1 950 000
	1 150	280	7.5	8 350	19 100	850 000	1 950 000
	1 150	345	7.5	10 900	26 300	1 110 000	2 680 000
	1 280	375	9.5	13 800	29 200	1 410 000	2 970 000
	1 420	488	15	20 300	41 000	2 070 000	4 150 000

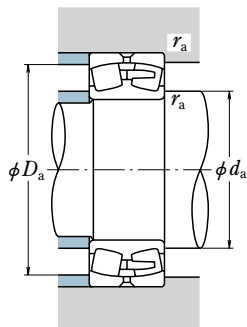

Dynamic Equivalent Load

$$P = XF_r + YF_a$$

$F_a/F_r \leq e$		$F_a/F_r > e$	
X	Y	X	Y
1	Y_3	0.67	Y_2

Static Equivalent Load

$$P_0 = F_r + Y_0 F_a$$

The values of e , Y_2 , Y_3 , and Y_0 are given in the table below.

Bearing Numbers		Abutment and Fillet Dimensions (mm)			Constant e	Axial Load Factors			Mass (kg) approx.
Cylindrical Bore	Tapered Bore ⁽¹⁾	d_a	D_a	r_a max.		Y_2	Y_3	Y_0	
239/670CAE4	239/670CAKE4	726	854	5	0.17	5.8	3.9	3.8	300
670SL9261E4	—	726	874	5	0.17	5.8	3.9	3.8	343
230/670CAE4	230/670CAKE4	735	925	6	0.22	4.7	3.1	3.1	571
240/670CAE4	240/670CAK30E4	735	925	6	0.30	3.3	2.2	2.2	773
231/670CAE4	231/670CAKE4	735	1 032	6	0.30	3.3	2.2	2.2	1 230
241/670CAE4	241/670CAK30E4	735	1 032	6	0.37	2.7	1.8	1.8	1 440
232/670CAE4	232/670CAKE4	753	1 142	10	0.37	2.7	1.8	1.8	2 210
675SL9261E4	—	732	874	5	0.15	6.9	4.6	4.5	296
700SL1061E4	—	766	964	6	0.22	4.6	3.1	3.0	690
239/710CAE4	239/710CAKE4	768	903	5	0.17	5.8	3.9	3.8	352
230/710CAE4	230/710CAKE4	776	974	6	0.22	4.6	3.1	3.0	647
240/710CAE4	240/710CAK30E4	776	974	6	0.29	3.4	2.3	2.2	861
231/710CAE4	231/710CAKE4	785	1 083	8	0.29	3.4	2.3	2.3	1 420
241/710CAE4	241/710CAK30E4	785	1 083	8	0.38	2.6	1.8	1.7	1 730
232/710CAE4	232/710CAKE4	795	1 201	10	0.36	2.8	1.9	1.8	2 470
—	730SL9861KE4	789	932	5	0.15	6.6	4.4	4.3	347
239/750CAE4	239/750CAKE4	810	952	5	0.17	6.0	4.1	4.0	398
750SL1061E4	—	810	952	5	0.17	6.0	4.1	4.0	433
230/750CAE4	230/750CAKE4	818	1 032	6	0.22	4.6	3.1	3.0	768
240/750CAE4	240/750CAK30E4	818	1 032	6	0.29	3.4	2.3	2.2	1 030
231/750CAE4	231/750CAKE4	826	1 152	8	0.29	3.4	2.3	2.3	1 700
232/750CAE4	232/750CAKE4	847	1 270	12	0.36	2.8	1.9	1.8	2 980
—	760SL1161KE4	828	1 081	6	0.23	4.4	3.0	2.9	1 010
780SL1161E4	—	849	1 121	6	0.22	4.5	3.0	2.9	1 130
239/800CAE4	239/800CAKE4	862	1 011	5	0.17	6.0	4.0	3.9	462
230/800CAE4	230/800CAKE4	870	1 091	6	0.21	4.7	3.2	3.1	870
800SL1161E4	—	870	1 091	6	0.21	4.7	3.2	3.1	941
240/800CAE4	240/800CAK30E4	870	1 091	6	0.27	3.7	2.5	2.5	1 130
231/800CAE4	231/800CAKE4	878	1 211	8	0.28	3.6	2.4	2.3	1 870
232/800CAE4	232/800CAKE4	899	1 328	12	0.35	2.8	1.9	1.9	3 250

Note ⁽¹⁾ The suffix K or K30 represents bearings with tapered bores (taper 1 : 12 or 1 : 30).

SPHERICAL ROLLER BEARINGS

Bore Diameter 850 – 1 120 mm

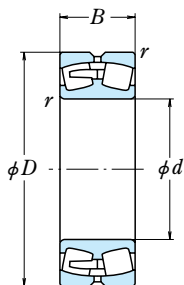

Cylindrical Bore

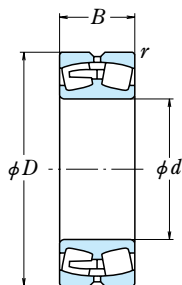

Tapered Bore

<i>d</i>	Boundary Dimensions (mm)			Basic Load Ratings			
	<i>D</i>	<i>B</i>	<i>r</i> min.	<i>C_r</i> (kN)	<i>C_{0r}</i>	<i>C_r</i> (kgf)	<i>C_{0r}</i>
850	1 120	200	6	6 100	15 200	620 000	1 550 000
	1 220	272	7.5	9 300	21 400	945 000	2 190 000
	1 220	305	7.5	9 300	23 500	950 000	2 390 000
	1 220	365	7.5	11 600	28 300	1 180 000	2 890 000
	1 360	400	12	15 800	34 000	1 610 000	3 500 000
	1 500	515	15	22 300	45 500	2 270 000	4 650 000
900	1 180	206	6	6 600	16 700	670 000	1 700 000
	1 280	280	7.5	9 850	22 800	1 000 000	2 330 000
	1 280	305	7.5	10 300	24 800	1 050 000	2 530 000
	1 280	375	7.5	12 800	31 500	1 300 000	3 250 000
	1 420	412	12	16 700	36 500	1 700 000	3 700 000
	1 580	515	15	23 400	47 500	2 380 000	4 850 000
950	1 250	224	7.5	7 600	19 900	775 000	2 030 000
	1 360	300	7.5	11 300	26 500	1 160 000	2 710 000
	1 360	412	7.5	14 500	36 500	1 480 000	3 700 000
	1 400	300	7.5	11 400	25 200	1 160 000	2 570 000
	1 660	530	15	24 700	50 500	2 520 000	5 150 000
1 000	1 320	236	7.5	8 200	21 700	835 000	2 210 000
	1 420	308	7.5	11 900	28 100	1 210 000	2 860 000
	1 420	320	7.5	11 500	28 400	1 170 000	2 890 000
	1 420	412	7.5	15 300	38 500	1 560 000	3 950 000
1 060	1 400	250	7.5	9 300	24 400	950 000	2 490 000
	1 500	325	9.5	13 000	31 500	1 330 000	3 200 000
	1 500	340	9.5	13 000	31 500	1 330 000	3 200 000
	1 500	438	9.5	16 800	43 000	1 720 000	4 350 000
1 120	1 460	250	7.5	9 500	26 000	970 000	2 650 000
	1 580	345	9.5	14 700	36 000	1 500 000	3 650 000
	1 580	360	9.5	14 700	36 000	1 500 000	3 650 000
	1 580	380	9.5	15 500	38 500	1 580 000	3 950 000
	1 580	462	9.5	18 700	49 500	1 910 000	5 050 000

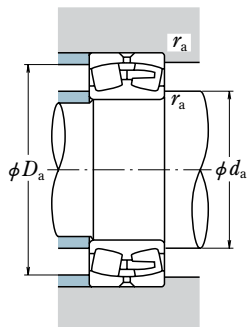

Dynamic Equivalent Load

$$P = XF_r + YF_a$$

$F_a/F_r \leq e$		$F_a/F_r > e$	
X	Y	X	Y
1	Y_3	0.67	Y_2

Static Equivalent Load

$$P_0 = F_r + Y_0 F_a$$

The values of e , Y_2 , Y_3 , and Y_0 are given in the table below.

Bearing Numbers		Abutment and Fillet Dimensions (mm)			Constant e	Axial Load Factors			Mass (kg) approx.
Cylindrical Bore	Tapered Bore ⁽¹⁾	d_a	D_a	r_a max.		Y_2	Y_3	Y_0	
239/850CAE4 230/850CAE4 850SL1261E4	239/850CAKE4 230/850CAKE4 —	914 922 922	1 070 1 160 1 160	5 6 6	0.16 0.21 0.22	6.2 4.8 4.6	4.2 3.2 3.1	4.1 3.1 3.0	523 1 020 1 170
240/850CAE4 231/850CAE4 232/850CAE4	240/850CAK30E4 231/850CAKE4 232/850CAKE4	922 941 951	1 160 1 279 1 407	6 10 12	0.28 0.28 0.35	3.6 3.5 2.8	2.4 2.4 1.9	2.4 2.3 1.9	1 350 2 260 3 890
239/900CAE4 230/900CAE4 900SL1261E4	239/900CAKE4 230/900CAKE4 —	966 974 974	1 128 1 219 1 219	5 6 6	0.16 0.20 0.20	6.4 4.9 4.9	4.3 3.3 3.3	4.2 3.2 3.2	591 1 160 1 250
240/900CAE4 231/900CAE4 232/900CAE4	240/900CAK30E4 231/900CAKE4 232/900CAKE4	974 993 1 003	1 219 1 338 1 485	6 10 12	0.28 0.28 0.33	3.6 3.6 3.0	2.4 2.4 2.0	2.4 2.4 2.0	1 520 2 490 4 300
239/950CAE4 230/950CAE4 240/950CAE4	239/950CAKE4 230/950CAKE4 240/950CAK30E4	1 026 1 026 1 026	1 189 1 297 1 297	6 6 6	0.16 0.21 0.28	6.3 4.8 3.6	4.2 3.2 2.4	4.1 3.2 2.3	732 1 400 1 880
950SL1462E4 232/950CAE4	— 232/950CAKE4	1 026 1 055	1 336 1 564	6 12	0.20 0.32	5.1 3.1	3.4 2.1	3.3 2.1	1 570 4 800
239/1000CAE4 230/1000CAE4 1000SL1461E4 240/1000CAE4	239/1000CAKE4 230/1000CAKE4 — 240/1000CAK30E4	1 078 1 078 1 078 1 078	1 258 1 356 1 356 1 356	6 6 6 6	0.16 0.20 0.20 0.27	6.4 4.9 5.1 3.7	4.3 3.3 3.5 2.5	4.2 3.2 3.4 2.4	881 1 560 1 630 2 010
239/1060CAE4 230/1060CAE4 1060SL1561E4 240/1060CAE4	239/1060CAKE4 230/1060CAKE4 — 240/1060CAK30E4	1 140 1 149 1 149 1 149	1 336 1 426 1 426 1 426	6 8 8 8	0.16 0.21 0.21 0.28	6.1 4.9 4.9 3.6	4.1 3.3 3.3 2.4	4.0 3.2 3.2 2.4	1 030 1 790 1 850 2 410
239/1120CAE4 230/1120CAE4 1120SL1562E4	239/1120CAKE4 230/1120CAKE4 —	1 203 1 211 1 211	1 395 1 505 1 505	6 8 8	0.15 0.20 0.20	6.6 4.9 4.9	4.4 3.3 3.3	4.3 3.2 3.2	1 100 2 150 2 230
1120SL1561E4 240/1120CAE4	— 240/1120CAK30E4	1 211 1 211	1 505 1 505	8 8	0.21 0.27	4.8 3.7	3.2 2.5	3.2 2.5	2 330 2 790

Note ⁽¹⁾ The suffix K or K30 represents bearings with tapered bores (taper 1 : 12 or 1 : 30).

SPHERICAL ROLLER BEARINGS

Bore Diameter 1 180 – 1 590 mm

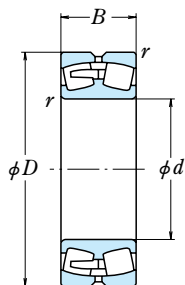

Cylindrical Bore

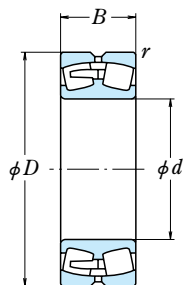

Tapered Bore

Boundary Dimensions (mm)				Basic Load Ratings			
d	D	B	r min.	C_r (kN)	C_{0r}	C_r (kgf)	C_{0r}
1 180	1 660	475	9.5	20 200	52 500	2 060 000	5 350 000
1 200	1 700	410	9.5	17 000	44 000	1 730 000	4 500 000
1 220	1 680	380	9.5	15 800	40 500	1 610 000	4 150 000
1 250	1 630	280	7.5	11 600	31 500	1 180 000	3 200 000
	1 750	390	9.5	17 400	44 500	1 770 000	4 500 000
	1 750	400	9.5	18 000	46 000	1 830 000	4 700 000
	1 750	500	9.5	21 000	59 500	2 140 000	6 050 000
1 320	1 720	350	7.5	13 500	38 500	1 380 000	3 900 000
	1 850	480	12	21 200	58 500	2 160 000	5 950 000
	1 850	530	12	22 600	63 500	2 310 000	6 500 000
1 350	1 800	500	7.5	19 200	56 500	1 960 000	5 750 000
1 370	1 780	265	9.5	11 900	31 500	1 210 000	3 250 000
1 400	1 820	315	9.5	14 300	40 500	1 460 000	4 100 000
	1 900	440	12	18 000	54 500	1 830 000	5 600 000
	1 900	530	12	22 700	64 500	2 310 000	6 600 000
	1 950	545	12	24 500	65 000	2 500 000	6 650 000
1 470	1 900	375	12	15 500	48 000	1 580 000	4 900 000
1 500	1 900	375	12	15 500	48 000	1 580 000	4 900 000
1 590	2 000	380	9.5	16 100	50 000	1 640 000	5 100 000

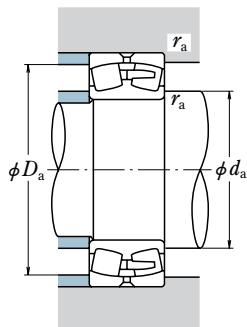

Dynamic Equivalent Load

$$P = XF_r + YF_a$$

$F_a/F_r \leq e$		$F_a/F_r > e$	
X	Y	X	Y
1	Y_3	0.67	Y_2

Static Equivalent Load

$$P_0 = F_r + Y_0 F_a$$

The values of e , Y_2 , Y_3 , and Y_0 are given in the table below.

Bearing Numbers		Abutment and Fillet Dimensions (mm)			Constant e	Axial Load Factors			Mass (kg) approx.
Cylindrical Bore	Tapered Bore ⁽¹⁾	d_a	D_a	r_a max.		Y_2	Y_3	Y_0	
240/1180CAE4	240/1180CAK30E4	1 273	1 583	8	0.27	3.7	2.5	2.4	3 180
1200SL1761E4	—	1 294	1 622	8	0.21	4.8	3.2	3.1	2 980
1220SL1661E4	—	1 315	1 603	8	0.19	5.2	3.5	3.4	2 500
239/1250CAE4	239/1250CAKE4	1 338	1 562	6	0.15	6.6	4.4	4.3	1 540
1250SL1761E4	—	1 346	1 671	8	0.20	5.0	3.3	3.3	2 860
1250SL1762E4	—	1 346	1 671	8	0.20	5.1	3.4	3.3	2 970
240/1250CAE4	240/1250CAK30E4	1 346	1 671	8	0.25	4.0	2.7	2.6	3 700
1320SL1761E4	—	1 411	1 650	6	0.17	5.9	4.0	3.9	2 100
1320SL1861E4	—	1 429	1 760	10	0.22	4.5	3.0	2.9	4 060
240/1320CAE4	240/1320CAK30E4	1 429	1 760	10	0.26	3.9	2.6	2.6	4 400
1350SL1851E4	—	1 442	1 728	6	0.25	4.0	2.7	2.6	3 660
—	1370SL1761KE4	1 471	1 701	8	0.13	7.7	5.1	5.0	1 650
239/1400CAE4	239/1400CAKE4	1 502	1 740	8	0.16	6.5	4.3	4.2	2 140
1400SL1962E4	—	1 513	1 809	10	0.20	5.0	3.3	3.3	3 710
1400SL1951E4	—	1 513	1 809	10	0.25	4.0	2.7	2.6	4 510
240/1400CAE4	240/1400CAK30E4	1 513	1 858	10	0.25	4.0	2.7	2.6	4 900
1470SL1961E4	—	1 585	1 809	10	0.16	6.4	4.3	4.2	2 770
1500SL1961E4	—	1 617	1 809	10	0.16	6.4	4.3	4.2	2 540
1590SL2061E4	—	1 700	1 916	8	0.15	6.7	4.5	4.4	2 770

Note (1) The suffix K or K30 represents bearings with tapered bores (taper 1 : 12 or 1 : 30).

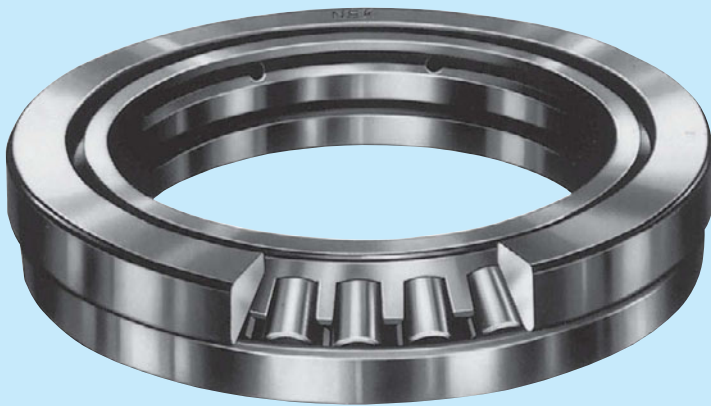

THRUST BEARINGS

Thrust Ball Bearings	Bore Diameter 90 – 630mm	B312
Cylindrical Roller Thrust Bearings	Bore Diameter 100 – 360mm	B318
Tapered Roller Thrust Bearings	Bore Diameter 101.600 – 600mm	B322
Spherical Thrust Roller Bearings	Bore Diameter 100 – 900mm	B328

Design, Types, and Features

Thrust Ball Bearings

Thrust ball bearings are composed of washer-like bearing rings with raceway grooves. Single-direction thrust ball bearings can sustain an axial load in only one direction.

Pressed cages are usually used, but larger ones are machined brass. The basic load ratings listed in the bearing tables are based on the standard cage type. If the type of cage is different for bearings with the same number, the number of balls may vary. In such a case, the load rating will differ from the one listed in the bearing tables.

Table 1 Standard Cages for Thrust Ball Bearings

Pressed Steel	Machined Brass
51118 – 51152X	51156X – 511/630X
51218 – 51236X	51238X – 512/630X
51318 – 51336X	51338X – 51392
51418X	51420X – 51448X

Cylindrical Roller Thrust Bearings

These are thrust bearings containing cylindrical rollers. They can sustain only axial loads, but they are suitable for heavy loads and have high axial rigidity.

The cages are machined brass.

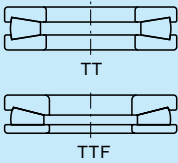

Tapered Roller Thrust Bearings

These are thrust bearings containing tapered rollers. TT-type bearings, which have a rib on the housing washer, can accurately guide the shaft in the radial direction. TTF-type bearings, which have no rib on the housing washer, can tolerate some eccentricity during operation.

Spherical Thrust Roller Bearings

These are thrust bearings containing barrel-shaped rollers (convex rollers). They have a self-aligning capability and are free of any influence of mounting error or shaft deflection. Besides the original type, the E type with pressed cages, and the EM type with machined brass cage for high load capacity are also available. Their bearing numbers are suffixed by E.

Since there are several places where lubrication is difficult, such as the area between the roller heads and shaft washer rib, the sliding surfaces between cage and guide sleeve, etc., oil lubrication should be used even at low speed.

The cages in the original type are machined brass.

Tolerances and Running Accuracy

Thrust Ball Bearings..... Table 2.5 (Pages A26 and A27)

Cylindrical Roller

Thrust Bearings.....According to Table 2.5 (Pages A26 and A27)

Tapered Roller Thrust Bearings.....Table 2.6 (Page A28)

Spherical Thrust Roller Bearings Table 2.7 (Page A29)

Recommended Fits Table 3.3 (Page A35)
 Table 3.5 (Page A36)

Thrust Ball Bearings

Cylindrical Roller Thrust Bearings

Tapered Roller Thrust Bearings

Spherical Thrust Roller Bearings

For inch design tapered roller thrust bearings, please contact **NSK**.

Dimensions Related to Mounting

The dimensions related to mounting of spherical thrust roller bearings are listed in the Bearing Table.

If the bearing load is heavy, it is necessary to design the shaft shoulder with ample strength in order to provide sufficient support for the shaft washerrib.

Permissible Misalignment

The permissible misalignment of spherical thrust roller bearings varies depending on the size, but it is approximately 1° to 2° with average loads.

Minimum Axial Load

It is necessary to apply some axial load to thrust bearings to prevent slippage between the rolling elements and raceways. For more details, please contact **NSK**.

SINGLE-DIRECTION THRUST BALL BEARINGS

Bore Diameter 90 – 170 mm

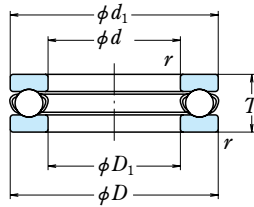

With Flat Seat

Boundary Dimensions (mm)				Basic Load Ratings				Bearing Numbers ⁽¹⁾
d	D	T	r min.	(kN)		(kgf)		
				C_a	C_{0a}	C_a	C_{0a}	
90	120	22	1	60.0	190	6 150	19 400	51118
	135	35	1.1	114	310	11 600	31 500	51218
	155	50	1.5	214	525	21 900	53 500	51318
	190	77	2.1	330	825	33 500	84 000	51418X
100	135	25	1	86.0	268	8 750	27 300	51120
	150	38	1.1	135	375	13 700	38 500	51220
	170	55	1.5	239	595	24 300	61 000	51320
	210	85	3	370	985	38 000	100 000	51420X
110	145	25	1	88.0	288	8 950	29 400	51122
	160	38	1.1	136	395	13 900	40 000	51222
	190	63	2	282	755	28 800	77 000	51322X
	230	95	3	415	1 150	42 000	118 000	51422X
120	155	25	1	90.0	310	9 150	31 500	51124
	170	39	1.1	141	430	14 400	44 000	51224
	210	70	2.1	330	930	33 500	95 000	51324X
	250	102	4	480	1 400	49 000	142 000	51424X
130	170	30	1	105	350	10 700	36 000	51126
	190	45	1.5	183	550	18 700	56 000	51226X
	225	75	2.1	350	1 030	35 500	105 000	51326X
	270	110	4	525	1 590	53 500	162 000	51426X
140	180	31	1	107	375	11 000	38 500	51128X
	200	46	1.5	186	575	18 900	59 000	51228X
	240	80	2.1	370	1 130	37 500	115 000	51328X
	280	112	4	550	1 750	56 500	178 000	51428X
150	190	31	1	110	400	11 200	41 000	51130X
	215	50	1.5	238	735	24 300	75 000	51230X
	250	80	2.1	380	1 200	39 000	123 000	51330X
	300	120	4	620	2 010	63 000	205 000	51430X
160	200	31	1	113	425	11 500	43 500	51132X
	225	51	1.5	249	805	25 400	82 000	51232X
	270	87	3	450	1 470	46 000	150 000	51332X
	320	130	5	650	2 210	66 000	226 000	51432X
170	215	34	1.1	135	510	13 800	52 000	51134X
	240	55	1.5	280	915	28 500	93 000	51234X
	280	87	3	465	1 570	47 500	160 000	51334X
	340	135	5	715	2 480	73 000	253 000	51434X

Note (1) The suffix X represents the inner ring (Shaft washer) outside diameter d_1 , which is smaller than the outer ring (housing washer) outside diameter D .

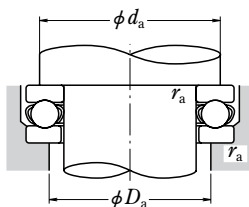

Dimensions (mm)		Abutment and Fillet Dimensions (mm)			Mass (kg)
d_1	D_1	d_a min.	D_a max.	r_a max.	approx.
120	92	108	102	1	0.646
135	93	117	108	1	1.69
155	93	129	116	1.5	3.83
187	93	149	131	2	10.2
135	102	121	114	1	0.96
150	103	130	120	1	2.25
170	103	142	128	1.5	4.98
205	103	165	145	2.5	14.8
145	112	131	124	1	1.04
160	113	140	130	1	2.42
187	113	158	142	2	7.18
225	113	181	159	2.5	20
155	122	141	134	1	1.12
170	123	150	140	1	2.7
205	123	173	157	2	9.7
245	123	196	174	3	26.2
170	132	154	146	1	1.68
187	133	166	154	1.5	3.95
220	134	186	169	2	12.1
265	134	212	188	3	32.3
178	142	164	156	1	1.83
197	143	176	164	1.5	4.3
235	144	199	181	2	15.6
275	144	222	198	3	34.7
188	152	174	166	1	1.95
212	153	189	176	1.5	5.52
245	154	209	191	2	16.7
295	153	238	212	3	43.5
198	162	184	176	1	2.07
222	163	199	186	1.5	6.04
265	164	225	205	2.5	21.5
315	164	254	226	4	52.7
213	172	197	188	1	2.72
237	173	212	198	1.5	7.41
275	174	235	215	2.5	22.5
335	174	269	241	4	61.2

SINGLE-DIRECTION THRUST BALL BEARINGS

Bore Diameter 180 – 340 mm

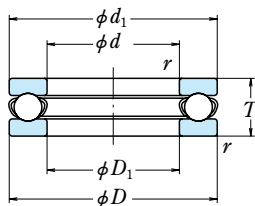

With Flat Seat

Boundary Dimensions (mm)				Basic Load Ratings				Bearing Numbers ⁽¹⁾
d	D	T	r min.	(kN)		(kgf)		
				C_a	C_{0a}	C_a	C_{0a}	
180	225	34	1.1	136	530	13 800	54 000	51136X
	250	56	1.5	284	955	28 900	97 000	51236X
	300	95	3	480	1 680	49 000	171 000	51336X
	360	140	5	750	2 730	76 500	278 000	51436X
190	240	37	1.1	172	655	17 500	67 000	51138X
	270	62	2	320	1 110	32 500	113 000	51238X
	320	105	4	550	1 960	56 000	199 000	51338X
	380	150	5	865	3 300	88 000	355 000	51438X
200	250	37	1.1	173	675	17 600	69 000	51140X
	280	62	2	315	1 110	32 500	113 000	51240X
	340	110	4	600	2 220	61 500	227 000	51340X
	400	155	5	850	3 330	87 000	335 000	51440X
220	270	37	1.1	179	740	18 200	75 500	51144X
	300	63	2	325	1 210	33 500	123 000	51244X
	360	112	4	615	2 380	63 000	243 000	51344X
	420	160	6	885	3 600	90 500	370 000	51444X
240	300	45	1.5	229	935	23 400	95 000	51148X
	340	78	2.1	420	1 650	43 000	168 000	51248X
	380	112	4	630	2 540	64 500	259 000	51348X
	440	160	6	915	3 900	93 500	400 000	51448X
260	320	45	1.5	233	990	23 800	101 000	51152X
	360	79	2.1	435	1 800	44 500	184 000	51252X
	420	130	5	750	3 200	76 500	330 000	51352X
280	350	53	1.5	315	1 310	32 000	134 000	51156X
	380	80	2.1	450	1 950	46 000	199 000	51256X
	440	130	5	765	3 400	78 000	350 000	51356X
300	380	62	2	360	1 560	36 500	159 000	51160X
	420	95	3	540	2 410	55 000	246 000	51260X
	480	140	5	860	3 950	87 500	405 000	51360X
320	400	63	2	365	1 660	37 500	169 000	51164X
	440	95	3	585	2 680	59 500	273 000	51264X
	500	140	5	880	4 200	90 000	430 000	51364X
340	420	64	2	375	1 760	38 500	179 000	51168X
	460	96	3	595	2 800	60 500	285 000	51268X
	540	160	5	1 020	5 100	104 000	520 000	51368X

Note (1) The suffix X represents the inner ring (Shaft washer) outside diameter d_1 , which is smaller than the outer ring (housing washer) outside diameter D .

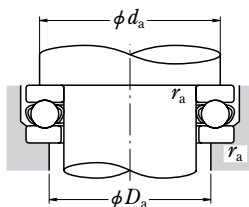

Dimensions (mm)		Abutment and Fillet Dimensions (mm)			Mass (kg)
d_1	D_1	d_a min.	D_a max.	r_a max.	approx.
222	183	207	198	1	2.79
247	183	222	208	1.5	7.94
295	184	251	229	2.5	28.3
355	184	285	255	4	70.5
237	193	220	210	1	3.6
267	194	238	222	2	11.8
315	195	266	244	3	36.5
375	195	300	270	4	85.5
247	203	230	220	1	3.75
277	204	248	232	2	12.3
335	205	282	258	3	43.6
400	204	317	285	4	99
267	223	250	240	1	4.09
297	224	268	252	2	13.6
360	225	304	278	3	48.6
420	228	341	303	5	107
297	243	276	264	1.5	6.55
335	244	299	281	2	23.7
380	245	324	298	3	51.9
435	245	359	321	5	115
317	263	296	284	1.5	7.01
355	264	319	301	2	25.1
420	263	357	324	4	75.9
347	283	322	308	1.5	12
375	284	339	321	2	27.1
435	285	375	345	4	78.8
376	304	348	332	2	17.2
415	304	371	349	2.5	43.5
480	305	407	375	4	103
396	324	368	352	2	18.6
435	325	391	369	2.5	45
500	325	427	395	4	109
416	344	388	372	2	19.9
455	345	411	389	2.5	47.9
540	345	457	425	4	151

SINGLE-DIRECTION THRUST BALL BEARINGS

Bore Diameter 360 – 630 mm

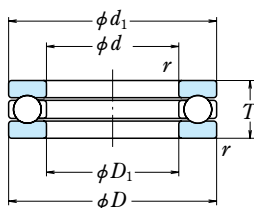

With Flat Seat

Boundary Dimensions (mm)				Basic Load Ratings				Bearing Numbers ⁽¹⁾
d	D	T	r min.	(kN)		(kgf)		
				C_a	C_{0a}	C_a	C_{0a}	
360	440	65	2	385	1 860	39 000	190 000	51172X 51272X 51372
	500	110	4	705	3 500	72 000	355 000	
	560	160	5	1 120	5 700	114 000	585 000	
380	460	65	2	385	1 910	39 500	195 000	51176X 51276 51376X
	520	112	4	740	3 800	75 500	390 000	
	600	175	6	1 140	6 100	116 000	620 000	
400	480	65	2	395	2 010	40 000	205 000	51180X 51280 51380X
	540	112	4	730	3 800	74 500	390 000	
	620	175	6	1 170	6 450	119 000	655 000	
420	500	65	2	400	2 110	41 000	215 000	51184X 51284 51384
	580	130	5	850	4 650	86 500	470 000	
	650	180	6	1 150	6 450	118 000	655 000	
440	540	80	2.1	515	2 850	53 000	291 000	51188X 51288 51388X
	600	130	5	865	4 850	88 000	490 000	
	680	190	6	1 220	7 150	124 000	730 000	
460	560	80	2.1	520	2 930	53 000	299 000	51192X 51292 51392
	620	130	5	880	5 050	89 500	515 000	
	710	195	6	1 200	7 150	123 000	730 000	
480	580	80	2.1	530	3 100	54 000	315 000	51196X 51296
	650	135	5	890	5 250	90 500	535 000	
530	640	85	3	640	3 900	65 500	395 000	511/530X 512/530
	710	140	5	1 010	6 200	103 000	635 000	
560	670	85	3	655	4 100	66 500	415 000	511/560X 512/560
	750	150	5	1 200	7 800	122 000	795 000	
600	710	85	3	675	4 400	68 500	450 000	511/600X 512/600
	800	160	5	1 170	7 800	120 000	795 000	
630	750	95	3	685	4 600	69 500	470 000	511/630X 512/630X
	850	175	6	1 400	10 000	143 000	1 020 000	

Note (1) The suffix X represents the inner ring (Shaft washer) outside diameter d_1 which smaller than the outer ring (housing washer) outside diameter D .

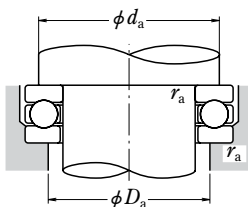

Dimensions (mm)		Abutment and Fillet Dimensions (mm)			Mass (kg)
d_1	D_1	d_a min.	D_a max.	r_a max.	approx.
436	364	408	392	2	21.5
495	365	442	418	3	68.8
560	365	477	445	4	156
456	384	427	413	2	22.4
520	385	464	438	3	74.5
595	385	509	471	5	199
476	404	447	433	2	23.5
540	405	484	458	3	77.7
615	405	529	491	5	207
495	424	467	453	2	24.4
580	425	517	485	4	109
650	425	556	516	5	232
535	444	498	482	2	40.5
600	445	537	505	4	115
675	445	579	541	5	269
555	464	518	502	2	42
620	465	557	525	4	119
710	465	606	566	5	291
575	484	538	522	2	43.7
650	485	582	550	4	137
635	534	597	575	2.5	56.7
710	535	637	605	4	165
665	564	625	605	2.5	59.6
750	565	672	640	4	200
705	605	665	645	2.5	63.3
800	605	717	685	4	241
745	634	700	680	2.5	83
845	635	759	721	5	299

CYLINDRICAL ROLLER THRUST BEARINGS

Bore Diameter 100 – 220 mm

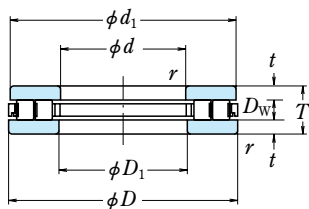

Boundary Dimensions (mm)				Basic Load Ratings (kN)				Bearing Numbers
d	D	T	r min.	C_a	C_{0a}	C_a	C_{0a} (kgf)	
100	170	42	1.5	292	1 110	29 700	113 000	100TMP93
110	160	38	1.1	228	855	23 300	87 000	110TMP12
	190	48	2	390	1 490	40 000	152 000	110TMP93
120	170	39	1.1	233	895	23 800	91 500	120TMP12
	210	54	2.1	505	1 930	51 500	197 000	120TMP93
	250	78	4	870	3 250	89 000	330 000	120TMP94
130	190	45	1.5	300	1 090	31 000	111 000	130TMP12
	225	58	2.1	585	2 370	59 500	241 000	130TMP93
	270	85	4	895	3 300	91 500	335 000	130TMP94
140	200	46	2	285	1 120	29 000	114 000	140TMP12
	240	60	2.1	610	2 360	62 500	240 000	140TMP93
	280	85	4	990	3 800	101 000	385 000	140TMP94
150	215	50	2	375	1 500	38 000	153 000	150TMP12
	250	60	2.1	635	2 510	64 500	256 000	150TMP93
	300	90	4	1 090	4 350	111 000	445 000	150TMP94
160	200	31	1	173	815	17 700	83 000	160TMP11
	270	67	3	745	3 150	76 000	320 000	160TMP93
170	240	55	1.5	485	1 960	49 500	200 000	170TMP12
	280	67	3	800	3 500	81 500	360 000	170TMP93
180	300	73	3	1 000	4 000	102 000	410 000	180TMP93
	360	109	5	1 640	6 200	167 000	630 000	180TMP94
190	270	62	3	705	2 630	71 500	269 000	190TMP12
	320	78	4	1 080	4 500	110 000	460 000	190TMP93
200	250	37	1.1	365	1 690	37 500	172 000	200TMP11
	340	85	4	1 180	5 150	120 000	525 000	200TMP93
220	270	37	1.1	385	1 860	39 500	189 000	220TMP11
	300	63	2	770	3 100	78 500	315 000	220TMP12
	360	85	4	1 210	5 450	124 000	560 000	220TMP93

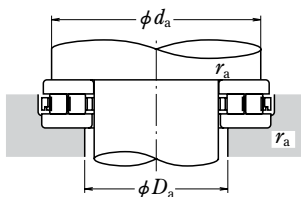

Dimensions (mm)				Abutment and Fillet Dimensions (mm)			Mass (kg)
\bar{d}_1	D_1	D_w	t	\bar{d}_a min.	D_a max.	r_a max.	approx.
170	103	16	13	159	110	1.5	4.25
160	113	15	11.5	150	119	1	2.66
190	113	19	14.5	179	120	2	6.15
170	123	15	12	160	129	1	2.93
210	123	22	16	199	129	2	8.55
245	125	30	24	233	135	3	20.6
187	133	19	13	177	142	1.5	4.5
225	133	22	18	214	140	2	10.4
270	133	32	26.5	254	150	3	26.2
197	143	17	14.5	188	153	2	4.85
240	143	25	17.5	226	154	2	12.2
280	143	32	26.5	262	158	3	27.5
215	153	19	15.5	202	163	2	6.15
250	153	25	17.5	236	165	2	12.8
295	155	32	29	280	166	3	33.4
200	162	11	10	191	168	1	2.21
265	164	25	21	255	173	2.5	16.9
237	173	22	16.5	227	182	1.5	8.2
280	173	25	21	265	183	2.5	17.7
300	185	32	20.5	284	194	2.5	22.5
354	189	45	32	335	205	4	58.2
266	195	30	16	255	200	2.5	11.8
320	195	32	23	303	205	3	27.6
247	203	17	10	242	207	1	4.1
340	205	32	26.5	322	218	3	34.5
267	223	17	10	262	227	1	4.5
297	224	30	16.5	287	232	2	13.5
360	220	32	26.5	342	238	3	36.9

CYLINDRICAL ROLLER THRUST BEARINGS

Bore Diameter 240 – 360 mm

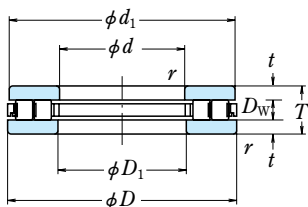

Boundary Dimensions (mm)				Basic Load Ratings (kN)				Bearing Numbers
d	D	T	r min.	C_a	C_{0a}	C_a	C_{0a} (kgf)	
240	300	45	1.5	435	2 160	44 500	220 000	240TMP11 240TMP12 240TMP93
	340	78	2.1	965	4 100	98 500	420 000	
	380	85	4	1 290	6 100	132 000	620 000	
260	320	45	1.5	460	2 350	46 500	240 000	260TMP11 260TMP12 260TMP93
	360	79	2.1	995	4 350	101 000	445 000	
	420	95	1.1	1 670	7 700	170 000	785 000	
280	350	53	1.5	545	2 800	55 500	285 000	280TMP11 280TMP12 280TMP93
	380	80	2.1	1 050	4 750	107 000	485 000	
	440	95	5	1 800	8 650	184 000	885 000	
300	380	62	2	795	4 000	81 000	410 000	300TMP11 300TMP12 300TMP93
	420	95	3	1 390	6 250	142 000	635 000	
	480	109	5	2 260	10 500	230 000	1 080 000	
320	400	63	2	820	4 250	84 000	435 000	320TMP11 320TMP12 320TMP93
	440	95	3	1 420	6 550	145 000	665 000	
	500	109	5	2 200	10 400	224 000	1 060 000	
340	460	96	3	1 450	6 800	148 000	695 000	340TMP12 340TMP93
	540	122	5	2 790	13 300	284 000	1 360 000	
360	500	110	4	1 870	8 600	191 000	875 000	360TMP12 360TMP93
	560	122	5	2 870	14 000	292 000	1 430 000	

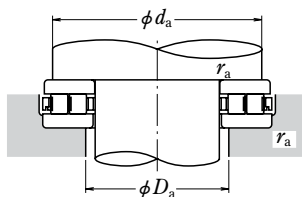

Dimensions (mm)				Abutment and Fillet Dimensions (mm)			Mass (kg)
d_1	D_1	D_w	t	d_a min.	D_a max.	r_a max.	approx.
297	243	18	13.5	288	251	1.5	7.2
335	244	32	23	322	258	2	23.3
380	240	32	26.5	362	258	3	39.4
317	263	18	13.5	308	272	1.5	7.75
355	264	32	23.5	342	276	2	25.2
420	260	38	28.5	398	282	1	55.2
347	283	20	16.5	335	294	1.5	11.6
375	284	32	24	362	296	2	27.2
438	282	38	28.5	421	299	4	58.4
376	304	25	18.5	365	315	2	16.7
415	304	38	28.5	398	322	2.5	42
480	300	45	32	460	318	4	81.7
396	324	25	19	385	335	2	18
435	325	38	28.5	418	340	2.5	44.5
500	325	45	32	474	346	4	85.9
455	345	38	29	438	360	2.5	47.4
540	345	50	36	516	364	4	115
495	365	45	32.5	475	383	3	68.1
560	360	50	36	536	384	4	120

TAPERED ROLLER THRUST BEARINGS

TT, TTF Types

Bore Diameter 101.600 – 168.275 mm

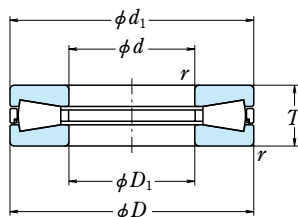

TT

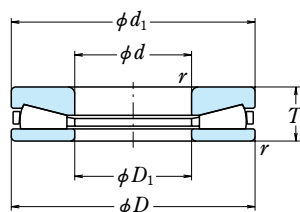

TTF

Boundary Dimensions (mm/inch)				Basic Load Ratings			
d	D	T	r min.	(kN)		(kgf)	
				C_a	C_{0a}	C_a	C_{0a}
101.600 4.0000	215.900 8.5000	46.038 1.8125	3.3	710	2 900	72 500	295 000
111.760 4.4000	223.520 8.8000	55.880 2.2000	3.3	790	2 920	80 500	298 000
114.300 4.5000	250.825 9.8750	53.975 2.1250	4.0	970	4 100	99 000	420 000
127.000 5.0000	266.700 10.5000	58.738 2.3125	4.8	1 040	4 350	107 000	445 000
	266.700 10.5000	58.738 2.3125	4.8	1 030	4 500	105 000	445 000
128.575 5.0620	265.100 10.4370	63.500 2.5000	6.4	1 040	4 350	107 000	445 000
130	250	70	2.1	1 100	4 100	113 000	420 000
135	245	65	2.1	855	3 100	87 000	315 000
150	300	90	5	1 470	6 300	150 000	640 000
152.400 6.0000	317.500 12.5000	69.850 2.7500	6.4	1 470	6 300	150 000	640 000
	317.500 12.5000	69.850 2.7500	6.4	1 550	6 700	158 000	685 000
165.100 6.5000	311.150 12.2500	88.900 3.5000	6.4	1 560	5 250	159 000	535 000
168.275 6.6250	304.800 12.0000	69.850 2.7500	6.4	1 230	5 000	126 000	510 000

Bearing Numbers	Dimensions (mm)		Corner Radius of Shaft or Housing r_a max.	Mass (kg)
	D_1	d_1		approx.
*101TT2151	103.200	214.300	3.3	8.9
*111TT2251	113.300	221.900	3.3	11.2
*114TT2551	114.500	250.825	4.0	14.4
*127TT2551	128.600	265.100	4.8	17.3
*127TTF2651	128.600	265.100	4.8	17.3
*128TT2651	128.900	265.100	6.4	18.2
130TTF2501	130.3	250	2	17
135TT2401 150TTF3001	135.3 152	245 306	2 4	14.5 34.2
*152TTF3151	152.700	315.900	6.4	28.9
*152TT3152	152.400	317.500	6.4	28.9
*165TT3151	165.400	311.150	6.4	33
*168TTF3051	169.000	302.500	6.4	24.1

Note * Bearings marked * are inch design.

TAPERED ROLLER THRUST BEARINGS

TT, TTF Types

Bore Diameter 170 – 241.300 mm

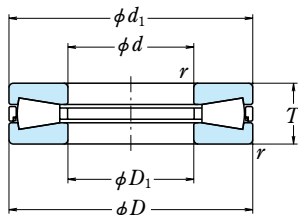

TT

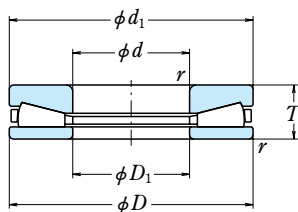

TTF

<i>d</i>	Boundary Dimensions (mm/inch)			Basic Load Ratings			
	<i>D</i>	<i>T</i>	<i>r</i> min.	(kN)		(kgf)	
				<i>C_a</i>	<i>C_{0a}</i>	<i>C_a</i>	<i>C_{0a}</i>
170	320	100	5	1 650	5 550	168 000	570 000
174.625 6.8750	358.775 14.1250	82.550 3.2500	6.4	1 740	7 400	177 000	755 000
	358.775 14.1250	82.550 3.2500	6.4	1 740	7 400	177 000	755 000
177.800 7.0000	368.300 14.5000	82.550 3.2500	8.0	1 900	8 250	194 000	840 000
203.200 8.0000	419.100 16.5000	92.075 3.6250	9.7	2 530	11 300	258 000	1 160 000
	419.100 16.5000	92.075 3.6250	9.7	2 530	11 300	258 000	1 160 000
	419.100 16.5000	120.650 4.7500	9.7	2 530	11 300	258 000	1 160 000
	419.100 16.5000	120.650 4.7500	9.7	2 530	11 300	258 000	1 160 000
206.375 8.1250	419.100 16.5000	120.370 4.7390	C10	2 590	11 700	264 000	1 190 000
228.600 9.0000	482.600 19.0000	104.775 4.1250	11.2	3 350	16 400	345 000	1 670 000
	482.600 19.0000	104.775 4.1250	11.2	3 350	16 400	345 000	1 670 000
234.950 9.2500	546.100 21.5000	127.000 5.0000	15.9	4 600	21 400	470 000	2 180 000
241	404	110	4	2 200	8 650	224 000	880 000
241.300 9.5000	496.888 19.5625	129.000 5.0787	C8	3 450	16 700	350 000	1 700 000

Bearing Numbers	Dimensions (mm)		Corner Radius of Shaft or Housing r_a max.	Mass (kg)
	D_1	d_1		approx.
170TT3201	170.5	320	4	39.3
*174TT3551	174.625	358.775	6.4	43.3
*174TTF3551	174.625	358.775	6.4	43.3
*177TT3651	180.400	365.800	8.0	45.9
*203TT4151	205.600	416.700	9.7	66.1
*203TTF4153A	203.200	419.100	9.7	66.1
*203TT4152	205.600	416.700	9.7	86.6
*203TTF4152	205.600	416.700	9.7	86.6
*206TT4151	206.375	419.100	6	85.5
*228TT4851	228.900	482.600	11.2	101
*228TTF4851	230.600	480.600	11.2	101
*234TT5451	237.000	544.000	15.9	165
241TTF4002	241	404	3	61.8
*241TT4952	241.300	496.888	5	130

Note * Bearings marked * are inch design.

TAPERED ROLLER THRUST BEARINGS

TT, TTF Types

Bore Diameter 254.000 – 600 mm

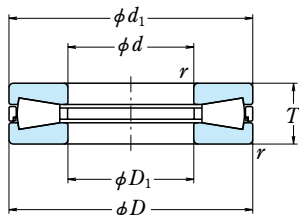

TT

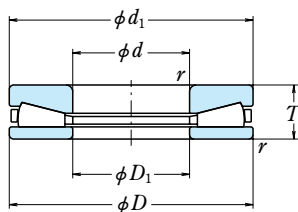

TTF

<i>d</i>	Boundary Dimensions (mm/inch)			Basic Load Ratings			
	<i>D</i>	<i>T</i>	<i>r</i> min.	(kN)		(kgf)	
				<i>C_a</i>	<i>C_{0a}</i>	<i>C_a</i>	<i>C_{0a}</i>
254.000 10.0000	539.750 21.2500	117.475 4.6250	11.2	3 950	18 600	405 000	1 890 000
260	360	75	2.1	1 110	4 650	113 000	475 000
273.050 10.7500	552.450 21.7500	133.350 5.2500	C8	4 400	20 700	445 000	2 110 000
279.400 11.0000	603.250 23.7500	136.525 5.3750	11.2	5 400	25 200	550 000	2 570 000
330	440	85	3	1 300	6 300	132 000	640 000
340	460	96	3	1 690	7 750	172 000	790 000
350	460	85	2	1 370	6 600	140 000	675 000
360	470	85	4	1 440	6 950	147 000	710 000
	600	120	4	3 700	20 100	380 000	2 050 000
380	550	110	4	2 760	12 100	282 000	1 240 000
406.400 16.0000	711.200 28.0000	146.050 5.7500	9.7	5 900	28 600	605 000	2 920 000
	838.200 33.0000	177.800 7.0000	12.7	8 950	46 500	910 000	4 750 000
431.800 17.0000	863.600 34.0000	228.600 9.0000	10.4	15 100	69 500	1 540 000	7 100 000
440	600	105	4	2 720	13 900	277 000	1 420 000
450	570	100	3	2 170	10 500	221 000	1 070 000
460	580	90	3	1 890	9 550	193 000	970 000
500	630	82	3	2 020	11 600	206 000	1 180 000
508	730.25	120.65	6	4 900	26 100	500 000	2 660 000
508.000 20.0000	990.600 39.0000	196.850 7.7500	12.7	12 000	65 000	1 220 000	6 650 000
558	780	120	9.5	4 800	25 500	485 000	2 600 000
558.800 22.0000	1 066.800 42.0000	285.750 11.2500	10.4	21 100	94 500	2 150 000	9 600 000
560	670	85	3	1 950	10 700	199 000	1 090 000
600	710	86	3	1 900	10 700	194 000	1 090 000

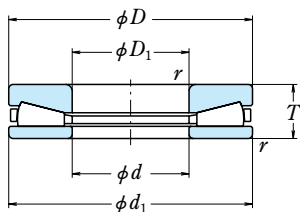

TTF-1

Bearing Numbers	Dimensions (mm)		Corner Radius of Shaft or Housing r_a max.	Mass (kg) approx.
	D_1	d_1		
*254TTF5351	254.000	539.750	11.2	142
260TTF3601	260.3	360	2	24.8
*273TT5551	273.050	552.450	5	164
*279TT6051	279.700	603.250	11.2	208
330TTF4401	331	440	2.5	38.5
340TTF4603	340	460	2.5	49.2
350TTF4602A⁽¹⁾	351	450	2	40.4
360TTF4701	360.4	470	3	41.4
360TTF6201	366	620	3	148
380TTF5501	381	550	3	92.9
*406TT7151	406.800	711.200	9.7	266
*406TT8351	406.800	837.800	12.7	510
*431TTF8651	435.000	862.000	10.4	683
440TTF6001	440	600	3	93.3
450TTF5701	455	569	2.5	65.4
460TTF5801	465	579	2.5	60
500TTF6301	505	628	2.5	64.3
508TT7301	509	730.25	5	177
*508TT9951	508.000	990.600	12.7	760
558TT7801	558	780	8	190
*558TTF1051	561.980	1 065.219	10.4	1 260
560TTF6701	565	668	2.5	61.4
600TTF7101	604	710	2.5	66.2

Note * Bearings marked * are inch design.

⁽¹⁾ For this bearing, the dimensional symbols are defined by Figure TTF-1.

SPHERICAL THRUST ROLLER BEARINGS

Bore Diameter 100 – 260 mm

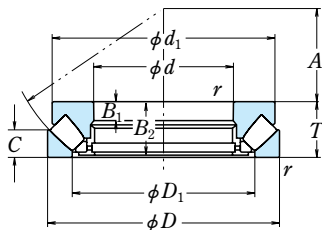
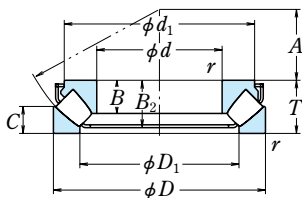

Boundary Dimensions (mm)				Basic Load Ratings				Bearing Numbers
d	D	T	r min.	C_a (kN)	C_{0a} (kgf)	C_a (kN)	C_{0a} (kgf)	
100	170	42	1.5	410	1 280	41 500	131 000	29320E 29420E
	210	67	3	840	2 400	86 000	245 000	
110	190	48	2	530	1 710	54 000	174 000	29322E 29422E
	230	73	3	1 010	2 930	103 000	299 000	
120	210	54	2.1	645	2 100	65 500	214 000	29324E 29424E
	250	78	4	1 160	3 400	119 000	350 000	
130	225	58	2.1	740	2 450	75 500	250 000	29326E 29426E
	270	85	4	1 330	3 900	135 000	400 000	
140	240	60	2.1	840	2 810	85 500	287 000	29328E 29428E
	280	85	4	1 370	4 200	140 000	425 000	
150	250	60	2.1	870	2 900	89 000	296 000	29330E 29430E
	300	90	4	1 580	4 900	162 000	500 000	
160	270	67	3	1 010	3 400	103 000	345 000	29332E 29432E
	320	95	5	1 740	5 400	178 000	550 000	
170	280	67	3	1 050	3 500	107 000	355 000	29334E 29434
	340	103	5	1 680	5 800	171 000	595 000	
180	300	73	3	1 230	4 200	125 000	430 000	29336E 29436
	360	109	5	1 870	6 500	190 000	660 000	
190	320	78	4	1 370	4 700	140 000	480 000	29338E 29438
	380	115	5	2 100	7 450	215 000	760 000	
200	280	48	2	540	2 310	55 000	236 000	29240
	340	85	4	1 570	5 450	160 000	555 000	29340E
	400	122	5	2 290	8 150	234 000	835 000	29440
220	300	48	2	560	2 500	57 000	255 000	29244
	360	85	4	1 340	5 200	137 000	530 000	29344
	420	122	6	2 350	8 650	240 000	880 000	29444
240	340	60	2.1	800	3 450	82 000	350 000	29248
	380	85	4	1 360	5 400	139 000	550 000	29348
	440	122	6	2 420	9 100	247 000	930 000	29448
260	360	60	2.1	855	3 850	87 500	395 000	29252
	420	95	5	1 700	6 800	173 000	695 000	29352
	480	132	6	2 820	10 700	287 000	1 090 000	29452

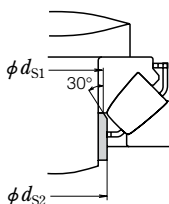
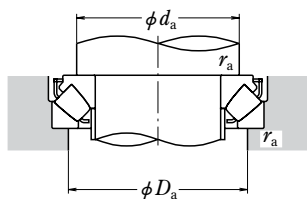

Dynamic Equivalent Load

$$P = 1.2F_r + F_a$$

Static Equivalent Load

$$P_0 = 2.8F_r + F_a$$

However, $F_r/F_a \leq 0.55$
must be satisfied.

d_1	Dimensions (mm)					Spacer Sleeve Dimensions (mm)		Abutment and Fillet Dimensions (mm)			Mass (kg) approx.
	D_1	B, B_1	B_2	C	A	d_{s1} max.	d_{s2} max.	$d_a^{(1)}$ min.	D_a max.	r_a max.	
152	128	26.2	38	20.8	58	107	107	130	150	1.5	3.6
185	144	43	59.5	33	62	111	111	150	175	2.5	10.3
169.5	142.5	30.3	43.5	24	64	117	117	145	165	2	5.2
200	157	47	64.5	36	69	121	129	165	190	2.5	13.3
187.5	156.5	34	48.5	27	70	130	130	160	180	2	7.3
215	171	50.5	69.5	38	74	132	142	180	205	3	16.6
203.5	168.5	37	53.5	28	76	141	143	170	195	2	8.9
235	185	54	74.5	42	81	143	153	195	225	3	21.1
216.5	179	38.5	54	30	82	148	154	185	205	2	10.4
244.5	195.5	54	74.5	42	86	153	162	205	235	3	22.2
224	190	38	54.5	29	87	158	163	195	215	2	10.8
266	209	58	81	44	92	164	175	220	250	3	27.3
243	203	42	60	33	92	169	176	210	235	2.5	14.3
278	224.5	60.5	84.5	46	99	175	189	230	265	4	32.1
252	214.5	42.2	60.5	32	96	178	188	220	245	2.5	14.8
310	243	37	99	50	104	—	—	245	285	4	43.5
270	227	46	65.5	36	103	189	195	235	260	2.5	19
330	255	39	105	52	110	—	—	260	300	4	52
288.5	244	49	69	38	110	200	211	250	275	3	23
345	271	41	111	55	117	—	—	275	320	4	60
266	236	15	46	24	108	—	—	235	255	2	8.5
306.5	257	53.5	75	41	116	211	224	265	295	3	28.5
365	280	43	117	59	122	—	—	290	335	4	69
285	254	15	46	24	117	—	—	260	275	2	9.2
335	280	29	81	41	125	—	—	285	315	3	33
385	308	43	117	58	132	—	—	310	355	5	74
325	283	19	57	30	130	—	—	285	305	2	16.5
355	300	29	81	41	135	—	—	300	330	3	35.5
405	326	43	117	59	142	—	—	330	375	5	79
345	302	19	57	30	139	—	—	305	325	2	18
390	329	32	91	45	148	—	—	330	365	4	48.5
445	357	48	127	64	154	—	—	360	405	5	105

Note ⁽¹⁾ For heavy load applications, a d_a value should be chosen which is large enough to support the shaft washer rib.

SPHERICAL THRUST ROLLER BEARINGS

Bore Diameter 280 – 480 mm

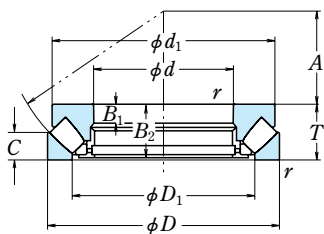

Boundary Dimensions (mm)				Basic Load Ratings				Bearing Numbers
d	D	T	r min.	(kN)		(kgf)		
				C_a	C_{0a}	C_a	C_{0a}	
280	380	60	2.1	885	4 100	90 000	420 000	29256
	440	95	5	1 830	7 650	187 000	780 000	29356
	520	145	6	3 400	13 100	345 000	1 330 000	29456
300	420	73	3	1 160	5 150	118 000	525 000	29260
	480	109	5	2 190	9 100	224 000	925 000	29360
	540	145	6	3 500	13 700	355 000	1 390 000	29460
320	440	73	3	1 190	5 450	122 000	555 000	29264
	500	109	5	2 230	9 400	227 000	960 000	29364
	580	155	7.5	3 650	14 600	370 000	1 490 000	29464
340	460	73	3	1 230	5 750	125 000	590 000	29268
	540	122	5	2 640	11 200	269 000	1 140 000	29368
	620	170	7.5	4 400	17 400	450 000	1 780 000	29468
360	500	85	4	1 550	7 300	158 000	745 000	29272
	560	122	5	2 670	11 500	272 000	1 180 000	29372
	640	170	7.5	4 200	17 200	430 000	1 750 000	29472
380	520	85	4	1 620	7 800	165 000	795 000	29276
	600	132	6	3 300	14 200	335 000	1 450 000	29376
	670	175	7.5	4 800	19 500	490 000	1 990 000	29476
400	540	85	4	1 640	8 000	167 000	815 000	29280
	620	132	6	3 250	14 500	330 000	1 480 000	29380
	710	185	7.5	5 350	22 100	545 000	2 250 000	29480
420	580	95	5	2 010	9 800	205 000	1 000 000	29284
	650	140	6	3 600	16 000	365 000	1 630 000	29384
	730	185	7.5	5 650	23 500	575 000	2 400 000	29484
440	600	95	5	2 030	10 100	207 000	1 030 000	29288
	680	145	6	3 750	16 700	380 000	1 710 000	29388
	780	206	9.5	6 550	27 200	665 000	2 770 000	29488
460	620	95	5	2 060	10 300	210 000	1 050 000	29292
	710	150	6	4 100	18 400	420 000	1 880 000	29392
	800	206	9.5	6 900	28 300	700 000	2 890 000	29492
480	650	103	5	2 370	12 100	241 000	1 240 000	29296
	730	150	6	4 150	19 000	425 000	1 940 000	29396
	850	224	9.5	7 200	31 000	730 000	3 150 000	29496

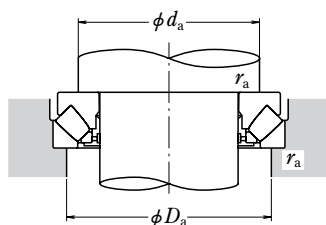

Dynamic Equivalent Load

$$P = 1.2F_r + F_a$$

Static Equivalent Load

$$P_0 = 2.8F_r + F_a$$

However, $F_r/F_a \leq 0.55$
most be satisfied.

d_1	Dimensions (mm)					Spacer Sleeve Dimensions (mm)		Abutment and Fillet Dimensions (mm)			Mass (kg) approx.
	D_1	B_1	B_2	C	A	d_{S1} max.	d_{S2} max.	$d_a^{(1)}$ min.	D_a max.	r_a max.	
365	323	19	57	30	150	—	—	325	345	2	19
410	348	32	91	46	158	—	—	350	390	4	52.5
480	384	52	140	68	166	—	—	390	440	5	132
400	353	21	69	38	162	—	—	355	380	2.5	30
450	379	37	105	50	168	—	—	380	420	4	74
500	402	52	140	70	175	—	—	410	460	5	140
420	372	21	69	38	172	—	—	375	400	2.5	32.5
470	399	37	105	53	180	—	—	400	440	4	77
555	436	55	149	75	191	—	—	435	495	6	175
440	395	21	69	37	183	—	—	395	420	2.5	33.5
510	428	41	117	59	192	—	—	430	470	4	103
590	462	61	164	82	201	—	—	465	530	6	218
480	423	25	81	44	194	—	—	420	455	3	51
525	448	41	117	59	202	—	—	450	495	4	107
610	480	61	164	82	210	—	—	485	550	6	228
496	441	27	81	42	202	—	—	440	475	3	52
568	477	44	127	63	216	—	—	480	525	5	140
640	504	63	168	85	230	—	—	510	575	6	254
517	460	27	81	42	212	—	—	460	490	3	55
590	494	44	127	64	225	—	—	500	550	5	150
680	536	67	178	89	236	—	—	540	610	6	306
553	489	30	91	46	225	—	—	490	525	4	72
620	520	48	135	68	235	—	—	525	575	5	170
700	556	67	178	89	244	—	—	560	630	6	323
575	508	30	91	49	235	—	—	510	545	4	77
645	548	49	140	70	245	—	—	550	600	5	190
745	588	74	199	100	260	—	—	595	670	8	407
592	530	30	91	46	245	—	—	530	570	4	80
666	567	51	144	72	257	—	—	575	630	5	210
765	608	74	199	100	272	—	—	615	690	8	420
624	556	33	99	55	259	—	—	555	595	4	97
690	590	51	144	72	270	—	—	595	650	5	215
810	638	81	216	108	280	—	—	645	730	8	545

Note ⁽¹⁾ For heavy load applications, a d_a value should be chosen which is large enough to support the shaft washer rib.

SPHERICAL THRUST ROLLER BEARINGS

Bore Diameter 500 – 1060 mm

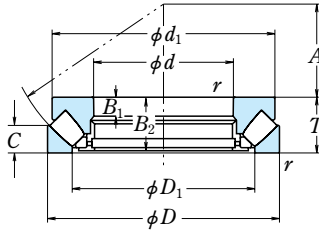

Boundary Dimensions (mm)				Basic Load Ratings				Bearing Numbers
d	D	T	r min.	(kN)		(kgf)		
				C_a	C_{0a}	C_a	C_{0a}	
500	670	103	5	2 390	12 400	244 000	1 270 000	292/500 293/500 294/500
	750	150	6	4 350	20 400	445 000	2 080 000	
	870	224	9.5	7 850	33 000	800 000	3 350 000	
530	800	160	7.5	5 050	23 300	515 000	2 380 000	293/530 294/530 294/530EM
	920	236	9.5	8 550	37 000	870 000	3 750 000	
	920	236	9.5	10 500	42 000	1 070 000	4 300 000	
560	850	175	7.5	5 700	26 700	580 000	2 730 000	293/560 294/560 294/560EM
	980	250	12	9 600	42 000	980 000	4 300 000	
	980	250	12	11 900	48 500	1 210 000	4 950 000	
600	800	122	5	3 300	17 800	340 000	1 810 000	292/600 294/600
	1 030	258	12	10 100	43 000	1 030 000	4 400 000	
630	1 090	280	12	11 600	51 500	1 180 000	5 250 000	294/630 294/630EM
	1 090	280	12	14 400	61 000	1 470 000	6 200 000	
670	1 150	290	15	12 500	56 000	1 270 000	5 700 000	294/670 294/670EM
	1 150	290	15	15 700	67 000	1 600 000	6 800 000	
710	1 220	308	15	14 300	65 500	1 460 000	6 700 000	294/710 294/710EM
	1 220	308	15	17 700	76 000	1 810 000	7 750 000	
750	1 280	315	15	15 100	69 000	1 530 000	7 000 000	294/750 294/750EM
	1 280	315	15	18 900	81 000	1 920 000	8 250 000	
800	1 360	335	15	16 600	77 500	1 700 000	7 900 000	294/800 294/800EM
	1 360	335	15	20 900	91 000	2 130 000	9 250 000	
850	1 440	354	15	23 100	102 000	2 360 000	2 360 000	294/850EM
900	1 520	372	15	19 900	96 000	2 030 000	9 750 000	294/900 294/900EM
	1 520	372	15	24 100	109 000	2 460 000	11 100 000	
1 000	1 670	402	15	26 200	123 000	2 670 000	12 500 000	294/1000EM
1 060	1 770	426	15	27 300	128 000	2 780 000	13 000 000	294/1060EM

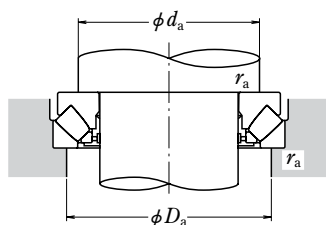

Dynamic Equivalent Load

$$P = 1.2F_r + F_a$$

Static Equivalent Load

$$P_0 = 2.8F_r + F_a$$

However, $F_r/F_a \leq 0.55$
must be satisfied.

d_1	Dimensions (mm)					Spacer Sleeve Dimensions (mm)		Abutment and Fillet Dimensions (mm)			Mass (kg) approx.
	D_1	B_1	B_2	C	A	d_{S1} max.	d_{S2} max.	$d_a^{(1)}$ min.	D_a max.	r_a max.	
645	574	33	99	55	268	—	—	575	615	4	100
715	611	51	144	74	280	—	—	615	670	5	220
830	661	81	216	107	290	—	—	670	750	8	560
760	648	54	154	76	295	—	—	655	710	6	284
880	696	85	228	114	310	—	—	715	790	8	660
840	686	86	228	116	308	—	—	725	800	8	628
810	687	59	168	85	310	—	—	695	750	6	354
935	744	91	242	124	325	—	—	755	835	10	800
890	727	90	241	122	328	—	—	770	850	10	756
772	688	39	117	58	321	—	—	690	735	4	169
985	780	93	249	127	345	—	—	800	885	10	895
1 040	830	100	268	136	365	—	—	845	935	10	1 100
995	815	101	270	137	365	—	—	860	950	10	1 050
1 090	870	105	278	140	385	—	—	895	990	12	1 250
1 050	864	104	280	141	387	—	—	905	1 000	12	1 200
1 160	920	132	292	148	407	—	—	950	1 050	12	1 500
1 110	917	111	298	149	415	—	—	965	1 060	12	1 430
1 220	970	128	301	152	429	—	—	995	1 105	12	1 680
1 170	964	113	305	153	436	—	—	1 020	1 110	12	1 600
1 300	1 030	121	323	162	445	—	—	1 060	1 175	12	2 010
1 250	1 030	120	324	163	462	—	—	1 080	1 180	12	1 920
1 315	1 095	127	342	172	501	—	—	1 160	1 260	12	2 250
1 450	1 164	135	360	185	520	—	—	1 190	1 315	12	2 760
1 420	1 165	134	359	185	530	—	—	1 220	1 330	12	2 700
1 550	1 300	145	385	195	590	—	—	1 360	1 470	12	3 450
1 630	1 385	153	400	205	610	—	—	1 440	1 560	12	4 030

Note ⁽¹⁾ For heavy load applications, a d_a value should be chosen which is large enough to support the shaft washer rib.

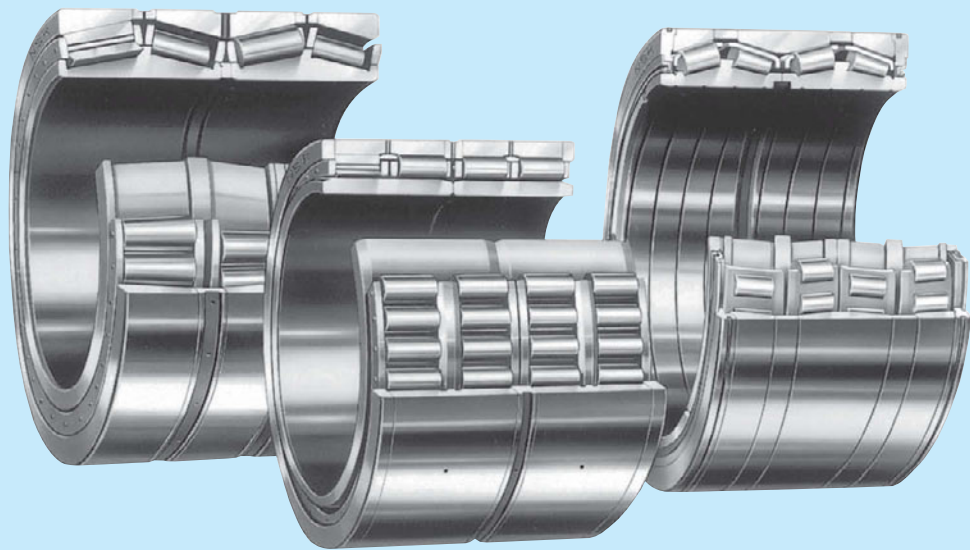

ROLLING BEARINGS FOR STEEL MILLS

Design, Types, and Features

Roll Neck Bearings

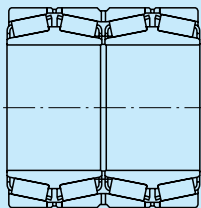

Four-Row Tapered Roller Bearings, KV (TQO)

Roll neck bearings for rolling mills are limited in size by the roll neck diameter and minimum roll diameter. Four-row tapered roller bearings are designed to have the highest possible load rating within this limited space.

This type of bearing has two double-cone assemblies, two cups, one double cup, and three spacers. The bearings have their internal clearance adjusted for each set, so it is necessary to assemble them correctly in accordance with their serial numbers and matching symbols.

This type of bearing is loosely fitted on its roll neck to facilitate mounting and disassembly. Accordingly, the roll neck must be lubricated to prevent scoring between the roll neck and bore surface caused by creep. For this reason and to prevent wear and seizure of the side surfaces of the cone and cone spacer, oil grooves are provided on one side of each cone and both sides of the cone spacer. The double cup and cup spacers are provided with an oil groove and holes.

Any hairline crack in the cone side caused by creep may result in its braking. Therefore, to prevent this and to improve the impact resistance, this type of bearing is usually made of carburized steel.

The cage is either a window type or pin type.

Bearings for oil mist lubrication are available. They have nozzle holes in the cup spacers, O-ring grooves, and O-rings in the cups.

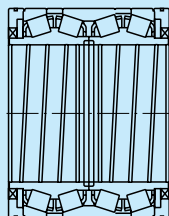

Sealed-Clean Four-Row Tapered Roller Bearings, KVE

These are basically the same as four-row tapered roller bearings. Their features are as follows:

- Long fatigue life
- Large reduction in lubrication grease consumption
- Extension of chock overhaul intervals and reduction of maintenance cost
- Bearing surrounding area remains cleaner

There are two basic types; one is a two seal type and the other is a four seal type. (Refer to Figures 3 and 4 on Page B343)

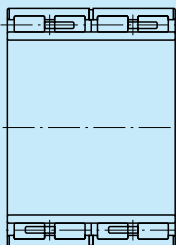

Four-Row Cylindrical Roller Bearings, RV

Four-row cylindrical roller bearings are mainly used on the roll necks of hot or cold rolling mills used for forming blooms, plates, and other stock. There are many variations of the bearings; the inner and outer rings may or may not have ribs, the inner ring may be in one or two pieces, the bore may be cylindrical or tapered, and other variations are available.

All four-row cylindrical roller bearings can sustain only radial loads and no axial loads; therefore, they must be used in combination with thrust bearings such as angular contact ball bearings, tapered roller bearings.

Since the inner ring raceway is generally cylindrical and without ribs, it can be separated from the outer ring assembly. This makes it possible to tightly fit the inner ring on the roll neck and regrind the roll with the inner ring raceway as the reference surface in order to minimize the roll runout. Some special bearings have an oversized inner ring raceway that allows raceway grinding after fitting on the roll neck. This permits grinding the raceway and roll surface together to further minimize runout. Such bearings are widely used where high accuracy is required.

With the inner ring tightly fit on the roll neck, there is no danger of creep, even at high speeds. Oil mist lubrication is possible with fittings and an O-ring in the outer ring.

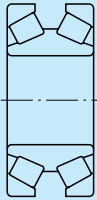

Double-Cone Tapered Roller Bearings, KDH (TDI)

Refer to Page B98.

Some variations of the cone are available such as a notch to prevent creep. For details, contact NSK.



Double-Direction Tapered Roller Thrust Bearings, TFD

The axial clearance or preload of the bearings is adjusted using spacers or springs.

Single-Row Deep Groove Ball Bearings

Refer to Page B5.

Matched Angular Contact Ball Bearings

Refer to Page B21.

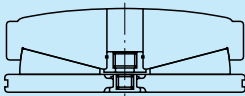

TFX

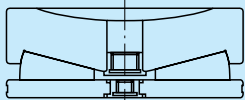

TFV

Tapered Roller Thrust Bearings for Adjusting Screws

These bearings, which are used at the ends of the adjusting screws of rolling mills, are full complement types for maximum load capacity. The face profile of the shaft washer of the TFX type is convex and that of the TFV type is concave. Holes or threads are provided in the inner or outer ring for lifting as shown in the figures. Since some bearings have special profiles, boundary dimensions, and tolerances, contact NSK when selecting one of these bearings.

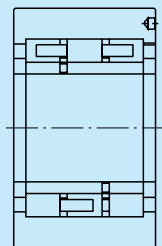

3PL

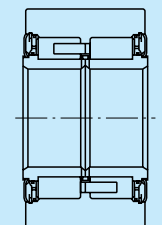

2U

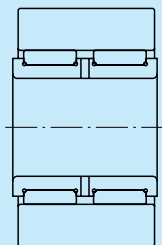

2S

Back-Up Roll Bearings for Sendzimir Mills

The bearings for this application have very thick outer rings compared with ordinary bearings because the bearing periphery serves as the back-up roll. Since these bearings must maintain high precision under heavy load, they are designed to have the maximum load capacity. The types available are cylindrical roller bearings, tapered roller bearings, spherical roller bearings, and needle roller bearings, with cylindrical roller bearings being most popular.

Since 3PL type cylindrical roller bearings and needle roller bearings cannot sustain axial loads, plastic thrust rings are used for the axial loads.

Several back-up roll bearings are mounted on one shaft and their outer ring peripheries serve as the back-up roll. Therefore, the outer ring radial runout and thickness variation after mounting are strictly controlled.

If the outer ring peripheries become rough, the bearings can be reused by regrinding the surface.

Roll Arrangement of a 20-high Sendzimir Mill

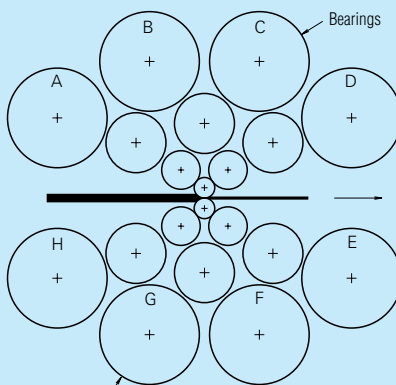

8 Back-Up Assemblies Marked A, B, C, D, E, F, G, H

Tolerances and Running Accuracy, Recommended Fits, and Internal Clearances

Table 1 Index

Bearing Types		Tolerances and Running Accuracy	Recommended Fits	Internal Clearances
Four-row tapered roller bearings Sealed-clean four-row tapered roller bearings	Metric	Table 2. 3 (Pages A20 to A23)	Table 2, 3 (Pages B338, B339)	Table 6 (Page B340) For sealed-clean bearings, contact NSK
	Inch	Table 2. 4 (Pages A24, A25)	Table 4, 5 (Pages B339)	
Four-row cylindrical roller bearings		Table 2. 2 (Pages A16 to A19)	(¹)	Table 3.11 (Page A41) Contact NSK
Double-cone tapered roller bearings	Metric	Table 2. 3 (Pages A20 to A23)	Table 3. 3 and 3. 5 (Pages A35, A36)	Table 3.13 (Page A43)
	Inch	Table 2. 4 (Pages A24, A25)	Table 3. 6 and 3. 7 (Pages A37, A38)	
Double-direction tapered roller thrust bearings		Table 2. 7 (Pages A29)	Table 3. 3 and 3. 5 (Pages A35, A36)	Contact NSK
Combined and angular contact ball bearings		Table 2. 2 (Pages A16 to A19)	Table 3. 3 and 3. 5 (Pages A35, A36)	Table 3.14 (Page A44)
Single-row deep groove ball bearings		Table 2. 2 (Pages A16 to A19)	Table 3. 3 and 3. 5 (Pages A35, A36)	Table 3.9 (Page A40)

Note (¹) For back-up rolls of rolling mills : The tolerances for roll neck diameter should be the figures in Table 7 (Page B340). G7 is recommended for the fit with the chock bore.

For other roll necks : Fits should generally be the figures in Tables 3.2 and 3.4 (Pages A35 and A36).

Table 2 Fits of Metric Design Four-Row Tapered Roller Bearings with Roll Necks

Units : μm

Nominal Bore Diameter d (mm)		Single Plane Mean Bore Dia. Deviation Δd_{mp}		Tolerances for Roll Neck Diameter		Clearances		Wear Limits of Roll Neck Ref.
over	incl	high	low	high	low	min.	max.	
80	120	0	- 20	- 120	- 150	100	150	300
120	180	0	- 25	- 150	- 175	125	175	350
180	250	0	- 30	- 175	- 200	145	200	400
250	315	0	- 35	- 210	- 250	175	250	500
315	400	0	- 40	- 240	- 300	200	300	600
400	500	0	- 45	- 245	- 300	200	300	600
500	630	0	- 50	- 250	- 300	200	300	600
630	800	0	- 75	- 325	- 400	250	400	800
800	1 000	0	- 100	- 375	- 450	275	450	900
1 000	1 250	0	- 125	- 425	- 500	300	500	1 000
1 250	1 600	0	- 160	- 510	- 600	350	600	1 200

Table 3 Fits of Metric Design Four-Row Tapered Roller Bearings with Chocks

Units : μm

Nominal Outside Diameter D (mm)		Single Plane Mean Outside Dia. Deviation ΔD_{mp}		Tolerances for Chock Bore Diameter		Clearances		Wear Limits of Chock Ref.
120	150	0	- 18	+ 57	+ 25	25	75	150
150	180	0	- 25	+100	+ 50	50	125	250
180	250	0	- 30	+120	+ 50	50	150	300
250	315	0	- 35	+115	+ 50	50	150	300
315	400	0	- 40	+110	+ 50	50	150	300
400	500	0	- 45	+105	+ 50	50	150	300
500	630	0	- 50	+100	+ 50	50	150	300
630	800	0	- 75	+150	+ 75	75	225	450
800	1 000	0	-100	+150	+ 75	75	250	500
1 000	1 250	0	-125	+175	+100	100	300	600
1 250	1 600	0	-160	+215	+125	125	375	750
1 600	2 000	0	-200	+250	+150	150	450	900

Table 4 Fits of Inch Design Four-Row Tapered Roller Bearings with Roll Necks

Units : μm

Nominal Bore Diameter d				Bore Diameter Deviation Δd_s		Tolerances for Roll Neck Diameter		Clearances		Wear Limits of Roll Neck Ref.
101.600	4.0000	127.000	5.0000	+ 25	0	-100	-125	100	150	300
127.000	5.0000	152.400	6.0000	+ 25	0	-125	-150	125	175	350
152.400	6.0000	203.200	8.0000	+ 25	0	-150	-175	150	200	400
203.200	8.0000	304.800	12.0000	+ 25	0	-175	-200	175	225	450
304.800	12.0000	609.600	24.0000	+ 51	0	-200	-250	200	301	600
609.600	24.0000	914.400	36.0000	+ 76	0	-250	-325	250	401	800
914.400	36.0000	1 219.200	48.0000	+102	0	-300	-400	300	502	1 000
1 219.200	48.0000	—	—	+127	0	-375	-475	375	602	1 200

Table 5 Fits of Inch Design Four-Row Tapered Roller Bearings with Chocks

Units : μm

Nominal Bore Diameter D				Outside Dia. Deviation ΔD_s		Tolerances for Chock Bore Diameter		Clearances		Wear Limits of Chock Ref.
—	—	304.800	12.0000	+ 25	0	+ 75	+ 50	25	75	150
304.800	12.0000	609.600	24.0000	+ 51	0	+150	+100	49	150	300
609.600	24.0000	914.400	36.0000	+ 76	0	+225	+150	74	225	450
914.400	36.0000	1 219.200	48.0000	+102	0	+300	+200	98	300	600
1 219.200	48.0000	1 524.000	60.0000	+127	0	+375	+250	123	375	750
1 524.000	60.0000	—	—	+157	0	+450	+300	143	450	900

Table 6 Standard Radial Internal Clearances in Four-Row Tapered Roller Bearings

Units : μm

Nominal Bore Diameter d (mm)		Clearances	
over	incl	high	low
80	120	25	45
120	180	30	50
180	250	40	60
250	315	50	70
315	400	60	80
400	500	70	90
500	630	80	100
630	800	100	120
800	1 000	120	140

Table 7 Recommended Back-up Roll Neck Tolerances and Fits for Four-Row Cylindrical Roller Bearings

Units : μm

Nominal Bore Diameter d or Outside Diameter D (mm)		Tolerances for Roll Neck Diameter		Tolerances for Chock Bore Diameter (G7)	
over	incl	high	low	high	low
80	120	+ 45	+ 23(n6)	—	—
120	140	+ 52	+ 27(n6)	+ 54	+ 14
140	180	+ 68	+ 43(p6)	+ 54	+ 14
180	200	+ 79	+ 50(p6)	+ 61	+ 15
200	225	+109	+ 80(r6)	+ 61	+ 15
225	250	+113	+ 84(r6)	+ 61	+ 15
250	280	+126	+ 94(r6)	+ 69	+ 17
280	315	+165	+130	+ 69	+ 17
315	355	+165	+130	+ 75	+ 18
355	400	+190	+150	+ 75	+ 18
400	450	+220	+170	+ 83	+ 20
450	500	+250	+190	+ 83	+ 20
500	560	+280	+210	+ 92	+ 22
560	630	+320	+250	+ 92	+ 22
630	710	+350	+270	+104	+ 24
710	800	+390	+310	+104	+ 24
800	900	+440	+350	+116	+ 26
900	1 000	+480	+390	+116	+ 26
1 000	1 250	+530	+430	+133	+ 28
1 250	1 600	—	—	+155	+ 30

Precautions for Mounting

Four-Row Tapered Roller Bearings

Four-row tapered roller bearings often have eight parts as shown below (two double cones with rollers, one double cup, two single cups, and three spacers). Each part is marked with a common serial number and matching symbol to indicate the assembly sequence. The common serial numbers (e.g., AE-11) prevent the mixing of parts between bearings. The assembly symbols, which consist of one or two letters, follow the serial numbers and indicate the position of each part in the assembled bearing. It is important to carefully observe these markings because an improper combination can result in an excessively small internal clearance that may cause seizure or an excessively large clearance that may cause premature fatigue due to a reduced loaded zone.

Example of serial numbers and matching symbols on four-row tapered roller bearings.

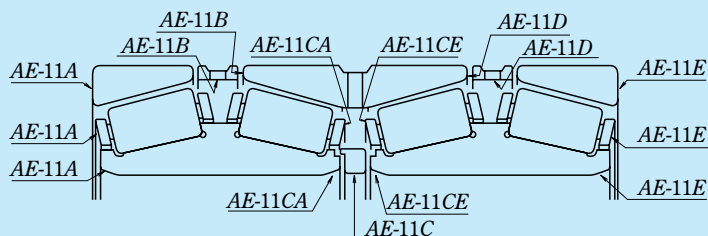

The sides of the cups are also marked with four load position numbers (① through ④) spaced at 90° intervals around each cup to show the proper angular orientation in an assembled bearing. To prolong bearing life, these load position numbers should be indexed 90° during remounting following maintenance.

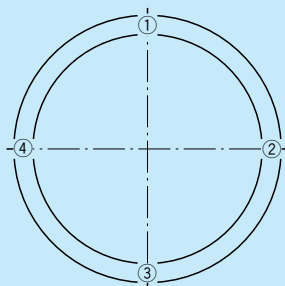

Load Position Numbers on
Four-Row Bearing Outer Rings

Sealed-Clean Four-Row Tapered Roller Bearings

When using Sealed-Clean bearings, it is important to provide proper water drain holes at both ends and to place an O-ring between the bearing retaining ring and roll neck. Since this bearing is mounted or dismounted as an assembly as shown in the photo below, use the proper lifting tools.

Consult NSK regarding the recommended greases most appropriate for Sealed-Clean four-row tapered roller bearings.

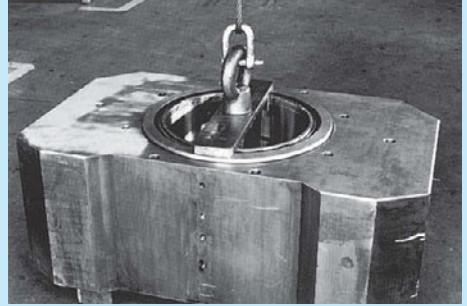
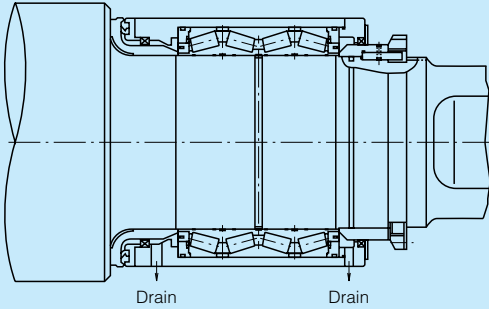

Four-Row Cylindrical Roller Bearings

Four-row cylindrical roller bearings have either cylindrical bores or tapered bores and are mounted on the shaft with interference. As shown in the figure below, four-row cylindrical roller bearings have serial numbers and matching symbols marked on the various parts. In this example, matching symbols are marked on two outer rings, one middle and two outer loose ribs, and four cages with rollers. It is important for all these parts to be correctly positioned when mounting them in their chock by paying attention to the matching symbols.

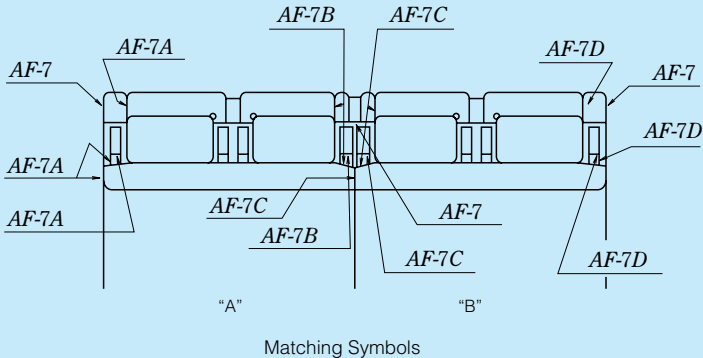

Figures of Typical Four-Row Tapered Roller Bearings

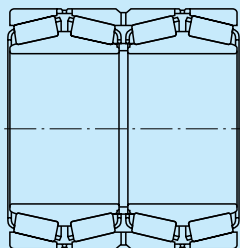

With Window Type Cages
Figure 1

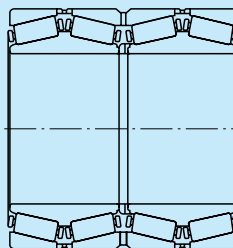

With Pin Type Cages
Figure 2

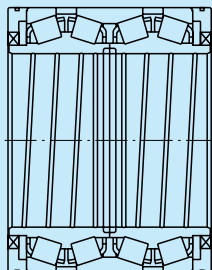

Basic Design of Two Seal Type
Figure 3

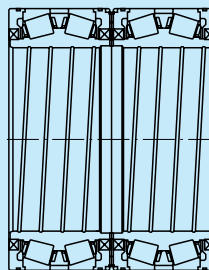

Basic Design of Four Seal Type
Figure 4

Variations of Bearing in Figure 3

- 3-1 Oil holes in cup spacers
- 3-2 Without intermediate bore seal (for dry rolling)
- 3-3 Without intermediate bore seal, with holes in cup spacers
- 3-4 With cone spacer, with intermediate bore seal
- 3-5 For vertical roll (special cup spacers)

Variations of Bearing in Figure 4

- 4-1 Oil holes in cup spacers
- 4-2 Clearance between cone faces

FOUR-ROW TAPERED ROLLER BEARINGS

KV (TQO) Type

Bore Diameter 100 – 139.700 mm

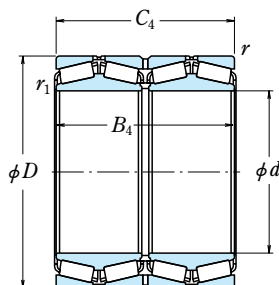

<i>d</i>	Boundary Dimensions (mm/inch)					Basic Load Ratings (kN) (kgf)			
	<i>D</i>	<i>B</i> ₄	<i>C</i> ₄	<i>r</i> ₁ min.	<i>r</i> min.	<i>C</i> _r	<i>C</i> _{0r}	<i>C</i> _r	<i>C</i> _{0r}
100	140	104	104	2	2	370	765	38 000	78 000
	170	155	155	2.5	2	800	1 320	81 500	135 000
105	150	110	110	1	1.5	410	805	42 000	82 000
	160	150	150	1	1.5	635	1 220	65 000	124 000
	190	210	210	2.5	2	1 260	2 230	128 000	227 000
107.950 4.2500	146.050 5.7500	106.365 4.1876	106.365 4.1876	1.5	1.5	320	705	32 500	72 000
110	155	114	114	2.5	2	435	895	44 000	91 000
	160	115	115	1	1.5	535	1 010	55 000	103 000
	180	120	120	2.5	2	600	940	61 000	96 000
115	160	120	120	1	1.5	505	1 070	51 500	109 000
120	170	124	124	2.5	2	550	1 080	56 500	110 000
	180	100	100	2.5	2	460	790	47 000	80 500
	200	132	132	2.5	2	770	1 260	78 500	128 000
120.650 4.7500	161.925 6.3750	106.365 4.1876	106.365 4.1876	1.5	1.5	340	695	35 000	70 500
127.000 5.0000	174.625 6.8750	141.288 5.5625	139.703 5.5001	0.8	1.5	655	1 320	67 000	134 000
	182.562 7.1875	158.750 6.2500	158.750 6.2500	1.5	3.3	780	1 770	79 500	181 000
130	184	134	134	2.5	2	625	1 290	63 500	132 000
	200	112	112	2.5	2	600	1 020	61 000	104 000
	210	136	136	2.5	2	790	1 270	80 500	129 000
130.175 5.1250	196.850 7.7500	200.025 7.8750	200.025 7.8750	1.5	3.3	990	2 030	101 000	207 000
133.350 5.2500	196.850 7.7500	193.675 7.6250	193.675 7.6250	1.5	3.3	990	2 030	101 000	207 000
135	180	160	160	2	1.5	535	1 280	54 500	130 000
	185	140	140	1	1	635	1 370	64 500	140 000
136.525 5.3750	190.500 7.5000	161.925 6.3750	161.925 6.3750	1.5	3.3	740	1 760	75 500	180 000
139.700 5.5000	200.025 7.8750	157.165 6.1876	160.340 6.3126	0.8	3.3	780	1 830	79 500	187 000

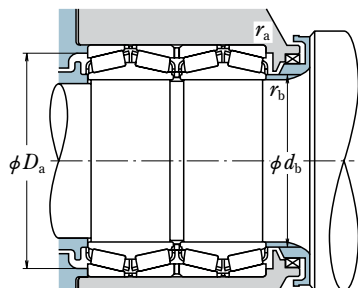

Dynamic Equivalent Load

$$P = XF_r + YF_a$$

$F_a/F_r \leq e$		$F_a/F_r > e$	
X	Y	X	Y
1	Y_3	0.67	Y_2

Static Equivalent Load

$$P_0 = F_r + Y_0 F_a$$

Where $Y_0 \doteq Y_3$

The values of e , Y_2 , and Y_3 are given in the table below.

Bearing Numbers	Figure ⁽¹⁾	Abutment and Fillet Dimensions (mm)				Constant e	Axial Load Factors			Mass (kg) approx.	Reference Bearing Numbers
		d_b	D_a	r_a max.	r_b max.		Y_2	Y_3			
100KV895	1	108	130	2	1.5	0.29	3.4	2.3	4.9	—	
100KV1701	1	112	156	2	2	0.32	3.2	2.1	14	—	
105KV1501	1	113	139	1	1	0.40	2.5	1.7	6.2	—	
105KV1601	1	113	146	1	1	0.37	2.7	1.8	10.8	—	
105KV1901	1	118	171	2	2	0.35	2.9	1.9	26	—	
*107KV1451	1	116	136	1.5	1.5	0.39	2.6	1.7	5.1	L521949DE-910-910DE	
110KV895	1	119	144	2	2	0.29	3.4	2.3	6.6	—	
110KV1601	1	118	149	1	1	0.43	2.3	1.6	7.4	—	
110KV81	1	126	166	2	2	0.39	2.6	1.7	12.1	—	
115KV1601a	1	123	149	1	1	0.39	2.6	1.7	7.4	—	
120KV895	1	129	159	2	2	0.32	3.2	2.1	8.5	—	
120KV80	1	132	167	2	2	0.40	2.5	1.7	8.5	—	
120KV81	1	134	184	2	2	0.39	2.6	1.7	16.5	—	
*120KV1651	1	129	151	1.5	1.5	0.43	2.3	1.6	6.1	L624549D-514-514D	
*120KV1752	1	129	162	1.5	0.8	0.42	2.4	1.6	11	M224749D-710-710D	
*127KV1851	1	136	167	3.3	1.5	0.31	3.3	2.2	13.8	48290D-220-220D	
130KV895	1	140	172	2	2	0.31	3.2	2.2	11.1	—	
130KV80	1	143	186	2	2	0.40	2.5	1.7	12.5	—	
130KV81	1	143	194	2	2	0.39	2.6	1.7	17.2	—	
*130KV1951	1	140	180	3.3	1.5	0.34	2.9	2.0	20.9	67391D-322-323D	
*133KV1951	1	142	180	3.3	1.5	0.34	2.9	2.0	19.3	67390D-322-322D	
135KV1802	1	144	169	1.5	2	0.28	3.6	2.4	11.1	—	
135KV1803	1	143	174	1	1	0.29	3.4	2.3	10.9	—	
*136KV1951	1	146	175	3.3	1.5	0.32	3.1	2.1	14.1	48393D-320-320D	
*139KV2051	1	151	185	3.3	0.8	0.34	3.0	2.0	16.2	48680D-620-620D	

Note * Bearings marked * are inch design.

⁽¹⁾ Refer to page **B 343**

FOUR-ROW TAPERED ROLLER BEARINGS

KV (TQO) Type

Bore Diameter 140 – 170 mm

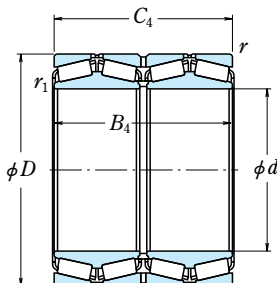

<i>d</i>	Boundary Dimensions (mm/inch)					Basic Load Ratings			
	<i>D</i>	<i>B</i> ₄	<i>C</i> ₄	<i>r</i> ₁ min.	<i>r</i> min.	(kN)		(kgf)	
						<i>C</i> _r	<i>C</i> _{0r}	<i>C</i> _r	<i>C</i> _{0r}
140	198	144	144	1	1.5	775	1 590	79 000	162 000
	198	144	144	2.5	2	715	1 450	72 500	148 000
	210	111	111	2.5	2	605	1 060	61 500	108 000
	210	114	114	2.5	2	605	1 060	61 500	108 000
	210	115	115	2.5	2	605	1 060	61 500	108 000
	225	145	145	3	2.5	880	1 450	89 500	148 000
	270	290	290	3	3	2 190	3 900	223 000	395 000
145	195	130	130	2	1.5	655	1 430	66 500	146 000
150	210	155	155	3	2	875	1 880	89 000	192 000
	210	190	190	1.5	2	985	2 310	101 000	235 000
	212	155	155	3	2.5	875	1 880	89 000	192 000
	225	120	120	3	2.5	715	1 270	72 500	130 000
	250	170	170	3	2.5	1 260	2 140	128 000	218 000
152.400 6.0000	222.250 8.7500	174.625 6.8750	174.625 6.8750	1.5	1.5	985	2 120	100 000	216 000
152.781 6.0150	244.475 9.6250	192.088 7.5625	187.325 7.3750	1.5	3.3	1 140	2 040	116 000	208 000
160	226	165	165	3	2.5	925	2 060	94 500	210 000
	240	130	130	3	2.5	790	1 420	80 500	145 000
	265	173	173	3	2.5	1 320	2 210	135 000	225 000
	270	180	180	3	2.5	1 320	2 210	135 000	225 000
165	270	240	240	6	3	1 780	3 600	181 000	365 000
165.100 6.5000	225.425 8.8750	165.100 6.5000	168.275 6.6250	0.8	3.3	820	2 160	84 000	220 000
170	230	175	175	2.5	2	990	2 310	101 000	235 000
	240	175	175	3	2.5	1 100	2 400	112 000	245 000
	260	144	144	3	2.5	950	1 660	97 000	169 000
	260	160	160	3	2.5	1 160	2 100	118 000	214 000
	280	181	181	3	2.5	1 500	2 570	153 000	262 000
	280	185	185	3	2.5	1 500	2 570	153 000	262 000

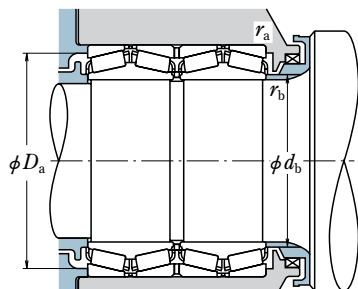

Dynamic Equivalent Load

$$P = XF_r + YF_a$$

$F_a/F_r \leq e$		$F_a/F_r > e$	
X	Y	X	Y
1	Y_3	0.67	Y_2

Static Equivalent Load

$$P_0 = F_r + Y_0 F_a$$

Where $Y_0 \doteq Y_3$

The values of e , Y_2 , and Y_3 are given in the table below.

Bearing Numbers	Figure ⁽¹⁾	Abutment and Fillet Dimensions (mm)				Constant	Axial Load Factors			Mass (kg) approx.	Reference Bearing Numbers
		d_b	D_a	r_a max.	r_b max.		e	Y_2	Y_3		
140KV1901	1	148	185	1.5	1	0.43	2.3	1.6	13.6	—	
140KV895	1	150	184	2	2	0.36	2.8	1.9	13.6	—	
140KV2101A	1	153	196	2	2	0.40	2.5	1.7	13	—	
140KV80	1	153	196	2	2	0.40	2.5	1.7	13.8	—	
140KV2102	1	153	196	2	2	0.40	2.5	1.7	13.3	—	
140KV81	1	154	208	2	2	0.40	2.5	1.7	20.9	—	
140KV2701	1	160	238	2.5	2.5	0.55	1.8	1.2	75.5	—	
145KV1901	1	154	184	1.5	1.5	0.31	3.3	2.2	10.7	—	
150KV89	1	160	196	2	2	0.40	2.5	1.7	16.2	—	
150KV2101	1	158	194	2	1	0.39	2.5	1.7	20.3	—	
150KV895	1	160	196	2	2	0.40	2.5	1.7	17	—	
150KV80	1	164	209	2	2	0.40	2.5	1.7	16.3	—	
150KV81	1	167	231	2	2	0.40	2.5	1.7	32.2	—	
*152KV2251	1	164	207	1.5	1.5	0.33	3.0	2.0	22.7	M231649D-610-610D	
*152KV2452	1	167	225	3.3	1.5	0.35	2.9	1.9	34.2	81603D-962-963D	
160KV895	1	172	210	2	2	0.29	3.4	2.3	20.5	—	
160KV80	1	175	224	2	2.5	0.40	2.5	1.7	19.9	—	
160KV2601	1	179	246	2	2	0.40	2.5	1.7	36.2	—	
160KV81	1	179	249	2	2.5	0.40	2.5	1.7	40.3	—	
165KV2701	1	186	247	2.5	5	0.36	2.8	1.9	55	—	
*165KV2252	1	175	208	3.3	0.8	0.38	2.6	1.8	20.2	46791D-720-721D	
170KV89	1	180	216	2	2	0.34	2.9	2.0	20.6	—	
170KV895	1	181	223	2	2.5	0.40	2.5	1.7	24.5	—	
170KV80	1	186	242	2	2	0.40	2.5	1.7	25.7	—	
170KV2601	1	189	242	2	2	0.39	2.6	1.7	29.5	—	
170KV2801	1	187	259	2	2	0.40	2.5	1.7	42.3	—	
170KV81	1	187	259	2	2	0.40	2.5	1.7	43	—	

Note * Bearings marked * are inch design.

⁽¹⁾ Refer to page **B 343**

FOUR-ROW TAPERED ROLLER BEARINGS

KV (TQ0) Type

Bore Diameter 177.800 – 203.200 mm

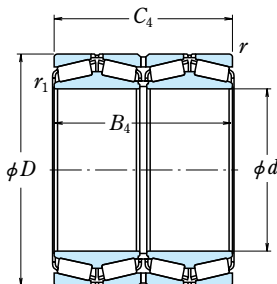

<i>d</i>	Boundary Dimensions (mm/inch)					Basic Load Ratings			
	<i>D</i>	<i>B</i> ₄	<i>C</i> ₄	<i>r</i> ₁ min.	<i>r</i> min.	<i>C</i> _r (kN)	<i>C</i> _{0r}	<i>C</i> _r (kgf)	<i>C</i> _{0r}
177.800 7.0000	247.650 9.7500	192.088 7.5625	192.088 7.5625	1.5	3.3	1 110	2 570	113 000	262 000
	273.050 10.7500	234.950 9.2500	234.947 9.2499	1.5	3.3	1 680	3 450	171 000	355 000
	288.925 11.3750	266.700 10.5000	266.700 10.5000	1.5	3.3	2 110	3 750	215 000	380 000
	304.800 12.0000	238.230 9.3791	233.362 9.1875	3.3	3.3	1 900	3 250	194 000	330 000
180	250	185	185	2.5	2	1 160	2 720	118 000	278 000
	254	185	185	2	2.5	1 230	2 750	126 000	280 000
	254	185	185	2	2.5	1 250	2 750	127 000	280 000
	260	160	160	2.5	2	1 030	2 040	105 000	208 000
	260	200	200	2.5	2	1 260	2 690	129 000	274 000
	280	158	158	3	2.5	1 230	2 240	126 000	228 000
	300 300	202 280	202 280	3 3	3 3	1 610 2 210	2 720 4 350	164 000 226 000	277 000 445 000
187.325 7.3750	269.875 10.6250	211.138 8.3125	211.138 8.3125	1.5	3.3	1 590	3 500	162 000	360 000
190	260	200	200	2.5	2	1 260	2 690	128 000	274 000
	268	196	196	3	2.5	1 380	3 100	141 000	315 000
	270	190	190	1.5	2.5	1 380	3 100	141 000	315 000
	290	160	160	3	2.5	1 250	2 210	128 000	225 000
	320	218	218	3	3	1 990	3 550	203 000	360 000
190.500 7.5000	266.700 10.5000	187.325 7.3750	188.912 7.4375	1.5	3.3	1 180	2 870	120 000	293 000
198.438 7.8125	284.162 11.1875	225.425 8.8750	225.425 8.8750	1.5	3.3	1 740	3 900	177 000	395 000
200	280	206	206	3	2.5	1 530	3 450	156 000	350 000
	282	206	206	3	2.5	1 530	3 450	156 000	350 000
	310	174	174	3	2.5	1 380	2 640	141 000	269 000
	310	200	200	3	2.5	1 660	3 100	169 000	315 000
	340	234	234	3	3	2 220	4 100	227 000	420 000
203.200 8.0000	317.500 12.5000	266.700 10.5000	266.700 10.5000	6.4	3.3	2 290	4 650	234 000	470 000

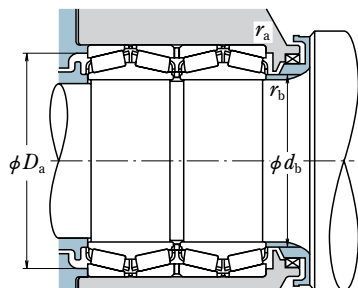

Dynamic Equivalent Load

$$P = XF_r + YF_a$$

$F_a/F_r \leq e$		$F_a/F_r > e$	
X	Y	X	Y
1	Y_3	0.67	Y_2

Static Equivalent Load

$$P_0 = F_r + Y_0 F_a$$

Where $Y_0 \doteq Y_3$

The values of e , Y_2 , and Y_3 are given in the table below.

Bearing Numbers	Figure ⁽¹⁾	Abutment and Fillet Dimensions (mm)				Constant e	Axial Load Factors		Mass (kg) approx.	Reference Bearing Numbers
		d_b	D_a	r_a max.	r_b max.		Y_2	Y_3		
*177KV2452	1	187	228	3.3	1.5	0.44	2.3	1.5	27.9	67791D-720-721D
*177KV2752	1	195	249	3.3	1.5	0.53	1.9	1.3	49.9	82681D-622-622D
*177KV2853	1	191	267	3.3	1.5	0.32	3.2	2.1	64	HM237545D-510-511XD
*177KV3051	1	198	280	3.3	3.3	0.36	2.8	1.9	68	EE280700D-1200-1201D
180KV89	1	190	231	2	2	0.44	2.3	1.5	27.9	—
180KV895	1	190	235	2	2	0.47	2.1	1.4	29.2	—
180KV2501	1	191	237	2	2	0.33	3.0	2.0	29.3	—
180KV2601	1	194	243	2	2	0.37	2.7	1.8	27.1	—
180KV2602	1	193	242	2	2	0.35	2.8	1.9	34.1	—
180KV80	1	197	260	2	2	0.35	2.9	1.9	35.4	—
180KV81	1	200	277	2.5	2.5	0.40	2.5	1.7	54.5	—
180KV3001	1	200	274	2.5	2.5	0.34	3.0	2.0	79.8	—
*187KV2651	1	199	250	3.3	1.5	0.35	2.9	1.9	39.3	M238849D-810-810D
190KV89	1	201	245	2	2	0.36	2.8	1.9	29	—
190KV895	1	202	249	2	2.5	0.40	2.5	1.7	34.1	—
190KV2702	1	201	250	2	1.5	0.40	2.5	1.7	34.7	—
190KV80	1	207	271	2	2	0.39	2.6	1.7	36.1	—
190KV81	1	210	293	2.5	2.5	0.40	2.5	1.7	71.2	—
*190KV2651	1	202	246	3.3	1.5	0.48	2.1	1.4	32.8	67885D-820-820D
*198KV2851	1	210	264	3.3	1.5	0.33	3.0	2.0	46.1	M240648D-611-611D
200KV89	1	213	262	2	2.5	0.40	2.5	1.7	38.1	—
200KV895	1	213	263	2	2.5	0.40	2.5	1.7	39.6	—
200KV80	1	219	288	2	2.5	0.40	2.5	1.7	47.2	—
200KV3101	1	218	288	2	2	0.39	2.6	1.7	53.6	—
200KV81	1	225	313	2.5	2.5	0.40	2.5	1.7	87.3	—
*203KV3154	1	224	292	3.3	6.4	0.45	2.2	1.5	77.2	93800D-125-127D

Note * Bearings marked * are inch design.

⁽¹⁾ Refer to page **B 343**

FOUR-ROW TAPERED ROLLER BEARINGS

KV (TQO) Type

Bore Diameter 205 – 234.950 mm

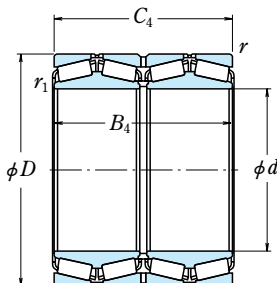

<i>d</i>	Boundary Dimensions (mm/inch)					Basic Load Ratings (kN) (kgf)			
	<i>D</i>	<i>B</i> ₄	<i>C</i> ₄	<i>r</i> ₁ min.	<i>r</i> min.	<i>C</i> _r	<i>C</i> _{0r}	<i>C</i> _r	<i>C</i> _{0r}
205	320	205	205	3	3	1 710	3 150	175 000	320 000
206.375 8.1250	282.575 11.1250	190.500 7.5000	190.500 7.5000	0.8	3.3	1 160	2 870	118 000	292 000
	282.575 11.1250	210.000 8.2677	210.000 8.2677	1.0	3.3	1 420	3 300	145 000	335 000
215.900 8.5000	288.925 11.3750	177.800 7.0000	177.800 7.0000	1.5	3.3	1 200	3 000	122 000	310 000
216.103 8.5080	330.200 13.0000	263.525 10.3750	269.875 10.6250	1.5	3.3	2 250	4 700	229 000	480 000
220	300	230	230	3	2.5	1 650	4 000	168 000	410 000
	310	226	226	3	3	1 770	4 000	181 000	410 000
	320	200	200	3	2.5	1 660	3 500	170 000	355 000
	320	250	250	3	3	2 050	4 750	209 000	485 000
	330	260	260	3	3	2 250	4 700	229 000	480 000
	340	190	190	3	3	1 480	2 790	151 000	285 000
	370	250	250	4	4	2 500	4 500	255 000	460 000
220.662 8.6875	314.325 12.3750	239.712 9.4375	239.712 9.4375	1.5	3.3	2 050	4 750	209 000	485 000
	314.325 12.3750	290.000 11.4173	290.000 11.4173	1.5	3.3	2 270	5 450	231 000	555 000
225	320	230	230	2.5	2	1 800	4 150	184 000	425 000
228.600 9.0000	355.600 14.0000	254.000 10.0000	254.000 10.0000	5.5	1.5	2 500	5 050	255 000	515 000
	355.600 14.0000	266.700 10.5000	260.350 10.2500	1.5	1.5	2 390	4 950	244 000	505 000
	364.000 14.3307	296.875 11.6880	296.875 11.6880	3.3	3.3	2 870	5 850	293 000	595 000
	400.050 15.7500	296.875 11.6880	296.875 11.6880	3.3	3.3	2 990	5 450	305 000	555 000
230	315	190	190	2.5	2	1 510	3 450	154 000	350 000
234.950 9.2500	327.025 12.8750	196.850 7.7500	196.850 7.7500	1.5	3.3	1 660	3 650	169 000	370 000

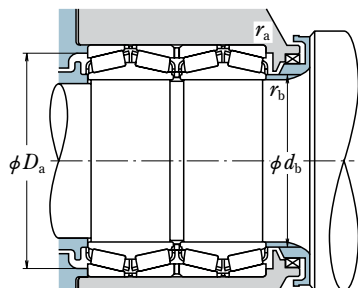

Dynamic Equivalent Load

$$P = XF_r + YF_a$$

$F_a/F_r \leq e$		$F_a/F_r > e$	
X	Y	X	Y
1	Y_3	0.67	Y_2

Static Equivalent Load

$$P_0 = F_r + Y_0 F_a$$

Where $Y_0 \doteq Y_3$

The values of e , Y_2 , and Y_3 are given in the table below.

Bearing Numbers	Figure ⁽¹⁾	Abutment and Fillet Dimensions (mm)				Constant e	Axial Load Factors		Mass (kg) approx.	Reference Bearing Numbers
		d_b	D_a	r_a max.	r_b max.		Y_2	Y_3		
205KV3201	1	224	297	2.5	2.5	0.40	2.5	1.7	58.1	—
*206KV2854	1	217	261	3.3	0.8	0.51	2.0	1.3	35.2	67986D-920-921D
*206KV2857	1	216	263	3.3	1.0	0.43	2.3	1.6	38.5	—
*215KV2851	1	226	268	3.3	1.5	0.48	2.1	1.4	32.9	LM742749D-714-714D
*216KV3351	1	230	301	3.3	1.5	0.55	1.8	1.2	80.6	9974DW-920-920D
220KV89	1	232	279	2	2.5	0.41	2.5	1.7	47.1	—
220KV895	1	235	289	2.5	2.5	0.40	2.5	1.7	52.2	—
220KV3201	1	236	299	2	2.5	0.40	2.5	1.7	51.9	—
220KV3202	1	234	295	2.5	2.5	0.33	3.0	2.0	68	—
220KV3301	1	234	302	2.5	2.5	0.55	1.8	1.2	75.7	—
220KV80	1	242	315	2.5	2.5	0.40	2.5	1.7	60.5	—
220KV81	1	245	340	3	3	0.39	2.6	1.7	106	—
*220KV3151	1	233	292	3.3	1.5	0.33	3.0	2.0	60.4	M244249D-210-210D
*220KV3152	1	233	291	3.3	1.5	0.33	3.0	2.0	71.8	—
225KV3201	1	239	298	2	2	0.41	2.4	1.6	58.8	—
*228KV3556	1	252	332	1.5	5.5	0.33	3.0	2.0	92.2	EE130901D-400-401D
*228KV3555	1	260	329	1.5	1.5	0.33	3.0	2.0	96.7	EE130904D-1400-1402D
*228KV3651	1	249	334	3.3	3.3	0.38	2.6	1.8	115	—
*228KV4051	1	254	364	3.3	3.3	0.37	2.7	1.8	152	EE529091D-157-158XD
230KV3101	1	243	296	2	2	0.36	2.8	1.9	43.1	—
*234KV3252	1	248	306	3.3	1.5	0.41	2.5	1.7	49.2	8576D-520-520D

Note * Bearings marked * are inch design.

⁽¹⁾ Refer to page **B 343**

FOUR-ROW TAPERED ROLLER BEARINGS

KV (TQO) Type

Bore Diameter 240 – 260.350 mm

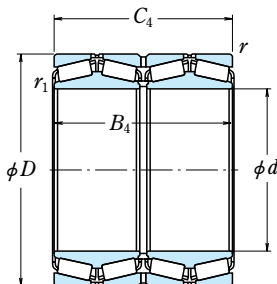

<i>d</i>	Boundary Dimensions (mm/inch)					Basic Load Ratings			
	<i>D</i>	<i>B</i> ₄	<i>C</i> ₄	<i>r</i> ₁ min.	<i>r</i> min.	(kN) <i>C</i> _r	<i>C</i> _{0r}	(kgf) <i>C</i> _r	<i>C</i> _{0r}
240	320	250	250	3	2.5	1 840	4 750	188 000	485 000
	338	248	248	3	3	2 280	5 300	233 000	540 000
	350	230	230	1.5	2	2 140	4 500	218 000	460 000
	360	194	194	3	3	1 850	3 600	189 000	370 000
	360	218	218	3	3	2 050	4 150	209 000	425 000
240.000 9.4488	365.000	290.000	290.000	2.5	2.5	2 720	5 700	277 000	580 000
	14.3701	11.4173	11.4173						
241.224 9.4970	355.498	228.600	228.600	1.5	3.3	1 960	4 250	200 000	435 000
	13.9960	9.0000	9.0000						
241.478 9.5070	349.148	228.600	228.600	1.5	3.3	1 960	4 250	200 000	435 000
	13.7460	9.0000	9.0000						
244.475 9.6250	327.025	193.675	193.675	1.5	3.3	1 510	3 700	154 000	375 000
	12.8750	7.6250	7.6250						
	327.025	193.680	193.680	1.5	3.3	1 690	3 950	172 000	405 000
247.650 9.7500	12.8750	7.6252	7.6252						
	400.050	249.235	253.995	1.5	3.3	2 510	4 850	256 000	495 000
250	15.7500	9.8124	9.9998						
	360	186	186	2.5	2	1 770	3 550	180 000	360 000
254.000 10.0000	365	270	270	2.5	3.3	2 600	6 150	265 000	630 000
	370	220	220	4	4	1 980	4 400	202 000	450 000
	381	320	320	2.5	3	3 150	7 100	320 000	725 000
	358.775	269.875	269.875	1.5	3.3	2 600	6 150	265 000	630 000
254.000 10.0000	14.1250	10.6250	10.6250						
	358.775	274.875	269.875	2.5	3.3	2 600	6 150	265 000	630 000
	14.1250	10.8219	10.6250						
260	360	272	272	3	2.5	2 520	5 950	257 000	605 000
	368	268	268	4	4	2 490	5 550	253 000	570 000
	400	213	213	4	4	2 230	4 200	227 000	430 000
	400	220	220	4	4	2 230	4 200	227 000	430 000
	400	320	320	4	4	3 750	7 950	385 000	810 000
	440	300	300	5	4	3 550	8 250	360 000	845 000
	440	300	300	5	4	3 550	8 250	360 000	845 000
260.350 10.2500	365.125	228.600	228.600	3.3	6.4	1 980	4 400	202 000	450 000
	14.3750	9.0000	9.0000						

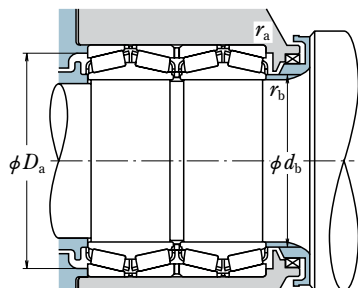

Dynamic Equivalent Load

$$P = XF_r + YF_a$$

$F_a/F_r \leq e$		$F_a/F_r > e$	
X	Y	X	Y
1	Y_3	0.67	Y_2

Static Equivalent Load

$$P_0 = F_r + Y_0 F_a$$

Where $Y_0 \doteq Y_3$

The values of e , Y_2 , and Y_3 are given in the table below.

Bearing Numbers	Figure ⁽¹⁾	Abutment and Fillet Dimensions (mm)				Constant e	Axial Load Factors		Mass (kg) approx.	Reference Bearing Numbers
		d_b	D_a	r_a max.	r_b max.		Y_2	Y_3		
240KV89	1	253	301	2	2	0.33	3.0	2.0	54.7	—
240KV895	1	254	316	2.5	2.5	0.36	2.8	1.9	68.5	—
240KV3501	1	254	327	2	1	0.42	2.4	1.6	72	—
240KV80	1	262	338	2.5	2.5	0.35	2.9	1.9	66.9	—
240KV3601	1	270	337	2.5	2.5	0.43	2.3	1.6	76.5	—
240KV81	1	268	369	3	3	0.40	2.5	1.7	127	—
*240KV3652	1M	256	336	2.5	2.5	0.46	2.2	1.5	106	—
*241KV3551	1	257	328	3.3	1.5	0.35	2.8	1.9	77.1	EE127094D-138-139D
*241KV3453	1	257	325	3.3	1.5	0.35	2.8	1.9	70.3	EE127097D-135-136D
*244KV3251	1	256	306	3.3	1.5	0.49	2.1	1.4	44.6	LM247748D-710-710D
*244KV3252	1	256	308	3.3	1.5	0.32	3.1	2.1	44.9	—
*247KV4051	1	271	369	3.3	1.5	0.39	2.5	1.7	119	EE220975D-1575-1576D
250KV3601	1	267	338	2	2	0.40	2.5	1.7	59.1	—
250KV3602	1	266	338	3.3	2.5	0.33	3.0	2.0	96.2	—
250KV3701	1	273	344	3	3	0.37	2.7	1.8	80.8	—
250KV3801	1	266	348	2.5	2	0.55	1.8	1.2	130	—
*254KV3551	1	267	335	3.3	1.5	0.33	3.0	2.0	85.6	M249748D-710-710D
*254KV3552	1	268	335	3.3	2.5	0.33	3.0	2.0	86	—
260KV89	1	275	338	2	2.5	0.34	3.0	2.0	82.2	—
260KV895	1	277	344	3	3	0.32	3.2	2.1	87.1	—
260KV4001	1	284	372	3	3	0.40	2.5	1.7	92.9	—
260KV80	1	283	372	3	3	0.40	2.5	1.7	96	—
260KV4002	1	280	370	3	3	0.35	2.8	1.9	144	—
260KV81	1	301	407	3	4	0.35	2.9	1.9	196	—
*260KV3651	1	277	339	6.4	3.3	0.37	2.7	1.8	71.2	EE134102D-143-144D

Note * Bearings marked * are inch design.
⁽¹⁾ Refer to page **B 343**
 The letter "M" indicates bearing for oil mist lubrication.

FOUR-ROW TAPERED ROLLER BEARINGS

KV (TQO) Type

Bore Diameter 266.700 – 279.578 mm

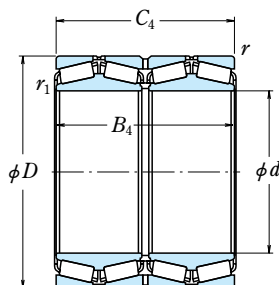

<i>d</i>	Boundary Dimensions (mm/inch)					Basic Load Ratings (kN) (kgf)			
	<i>D</i>	<i>B</i> ₄	<i>C</i> ₄	<i>r</i> ₁ min.	<i>r</i> min.	<i>C</i> _r	<i>C</i> _{0r}	<i>C</i> _r	<i>C</i> _{0r}
266.700 10.5000	355.600 14.0000	230.188 9.0625	228.600 9.0000	1.5	3.3	2 110	5 050	215 000	515 000
	393.700 15.5000	269.878 10.6251	269.878 10.6251	3.3	6.4	2 610	5 550	266 000	570 000
	406.400 16.0000	268.290 10.5626	260.355 10.2502	3.3	6.4	2 610	5 550	266 000	570 000
269.875 10.6250	381.000 15.0000	282.575 11.1250	282.575 11.1250	3.3	3.3	2 710	6 350	277 000	650 000
270	364 410	260 222	260 222	1.5 4	2 4	2 240 2 320	5 700 4 400	228 000 237 000	580 000 445 000
	276.225 10.8750	380.898 14.9960	187.325 7.3750	203.200 8.0000	3.3	6.4	1 650	3 600	168 000
	393.700 15.5000	269.878 10.6251	269.878 10.6251	1.5	6.4	2 850	6 400	290 000	650 000
	406.400 16.0000	268.290 10.5626	260.355 10.2502	1.5	6.4	2 400	5 150	245 000	525 000
	279.400 11.0000	393.700 15.5000	269.875 10.6250	269.875 10.6250	1.5	6.4	2 350	5 450	239 000
	469.900 18.5000	346.075 13.6250	349.250 13.7500	6.4	3.3	4 050	8 250	415 000	840 000
	495.300 19.5000	282.735 11.1313	285.750 11.2500	1.5	3.3	3 700	7 150	375 000	730 000
	495.300 19.5000	289.085 11.3813	292.100 11.5000	1.5	3.3	3 700	7 150	375 000	730 000
279.578 11.0070	380.898 14.9960	244.475 9.6250	244.475 9.6250	1.5	3.3	2 110	6 000	216 000	610 000
	381.000 15.0000	187.325 7.3750	193.675 7.6250	3.3	3.3	1 650	3 600	168 000	370 000

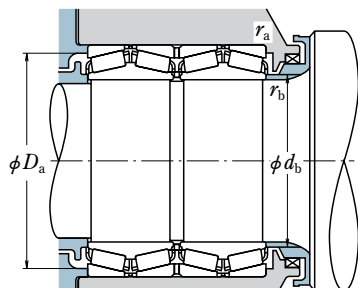

Dynamic Equivalent Load

$$P = XF_r + YF_a$$

$F_a/F_r \leq e$		$F_a/F_r > e$	
X	Y	X	Y
1	Y_3	0.67	Y_2

Static Equivalent Load

$$P_0 = F_r + Y_0 F_a$$

Where $Y_0 \doteq Y_3$

The values of e , Y_2 , and Y_3 are given in the table below.

Bearing Numbers	Figure ⁽¹⁾	Abutment and Fillet Dimensions (mm)				Constant e	Axial Load Factors		Mass (kg) approx.	Reference Bearing Numbers
		d_b	D_a	r_a max.	r_b max.		Y_2	Y_3		
*266KV3552	1	277	335	3.3	1.5	0.36	2.8	1.9	60.6	LM451349D-310-310D
*266KV3951	1	288	364	6.4	3.3	0.40	2.5	1.7	108	EE275106D-155-156D
*266KV4051	1	288	372	6.4	3.3	0.40	2.5	1.7	121	EE275106D-160-161D
*269KV3851	1	287	356	3.3	3.3	0.33	3.0	2.0	99.3	M252349D-310-310D
270KV3601 270KV80	1M 1	282 293	342 381	2 3	1 3	0.39 0.35	2.6 2.9	1.7 1.9	76.7 99.7	— —
*276KV3851	1	294	352	6.4	3.3	0.58	1.7	1.2	64.4	89108D-149-149XD
*276KV3951	1	291	364	6.4	1.5	0.40	2.5	1.7	102	EE275109DW-155-156D
*276KV4051	1	291	371	6.4	1.5	0.40	2.5	1.7	112	EE275109D-160-161D
*279KV3951	1	294	362	6.4	1.5	0.40	2.5	1.7	100	EE135111D-155-156D
*279KV4651	1	313	431	3.3	6.4	0.38	2.7	1.8	243	EE722111D-185-186D
*279KV4951	1	311	460	3.3	1.5	0.40	2.5	1.7	235	EE941106D-950-951XD
*279KV4952	1	311	460	3.3	1.5	0.40	2.5	1.7	240	EE941106D-950-952XD
*279KV3854	1	296	355	3.3	1.5	0.43	2.3	1.6	84.1	LM654644D-610-610D
*279KV3855	1	296	357	3.3	3.3	0.58	1.7	1.2	60.7	89111D-148-151XD

Note * Bearings marked * are inch design.
⁽¹⁾ Refer to page **B 343**
 The letter "M" indicates bearing for oil mist lubrication.

FOUR-ROW TAPERED ROLLER BEARINGS

KV (TQO) Type

Bore Diameter 280 – 304.800 mm

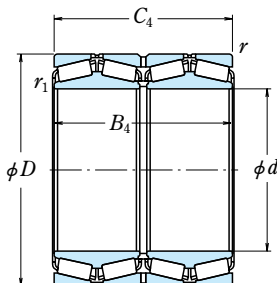

<i>d</i>	Boundary Dimensions (mm/inch)					Basic Load Ratings (kN) (kgf)			
	<i>D</i>	<i>B</i> ₄	<i>C</i> ₄	<i>r</i> ₁ min.	<i>r</i> min.	<i>C</i> _r	<i>C</i> _{0r}	<i>C</i> _r	<i>C</i> _{0r}
280	380	290	290	2	3	2 550	6 400	260 000	650 000
	395	288	288	4	4	2 770	6 650	283 000	675 000
	420	224	224	4	4	2 480	4 950	253 000	505 000
	420	250	250	4	4	2 780	5 700	284 000	580 000
	460	305	305	5	5	4 000	7 700	410 000	785 000
	460	324	324	5	5	4 100	7 850	420 000	800 000
285.750 11.2500	380.898 14.9960	244.475 9.6250	244.475 9.6250	1.5	3.3	2 110	6 000	216 000	610 000
288.925 11.3750	406.400 16.0000	298.450 11.7500	298.450 11.7500	3.3	3.3	3 050	7 350	315 000	745 000
292.100 11.5000	422.275 16.6250	269.875 10.6250	269.875 10.6250	6.4	3.3	2 970	6 650	305 000	680 000
300	420	310	310	4	4	3 250	8 150	330 000	830 000
	424	310	310	4	4	3 050	7 700	315 000	785 000
	430	280	280	3	3	3 050	6 950	315 000	710 000
	430	300	300	3	3	3 550	8 250	360 000	845 000
	460	248	248	4	4	2 910	6 050	297 000	615 000
	460	360	360	4	4	4 450	9 900	455 000	1 010 000
	470	270	270	4	4	3 750	7 500	380 000	765 000
	470	292	292	4	4	4 100	8 350	415 000	855 000
	470	310	310	4	4	3 900	7 850	395 000	805 000
	500	332	332	5	5	4 650	8 950	475 000	915 000
	500	380	380	5	5	4 900	9 600	500 000	980 000
300.038 11.8125	422.275 16.6250	311.150 12.2500	311.150 12.2500	3.3	3.3	3 400	8 200	345 000	840 000
304.648 11.9940	438.048 17.2460	280.990 11.0626	279.400 11.0000	3.3	4.8	3 050	6 750	310 000	685 000
304.800 12.0000	419.100 16.5000	269.875 10.6250	269.875 10.6250	1.5	6.4	2 930	7 250	299 000	740 000
	482.600 19.0000	345.000 13.5827	345.000 13.5827	3.3	4.8	5 150	10 400	525 000	1 060 000
	482.600 19.0000	365.125 14.3750	377.825 14.8750	3.3	4.8	5 150	10 500	525 000	1 070 000

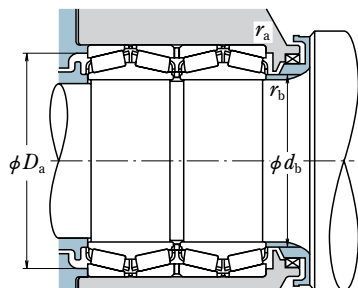

Dynamic Equivalent Load

$$P = XF_r + YF_a$$

$F_a/F_r \leq e$		$F_a/F_r > e$	
X	Y	X	Y
1	Y_3	0.67	Y_2

Static Equivalent Load

$$P_0 = F_r + Y_0 F_a$$

Where $Y_0 \doteq Y_3$

The values of e , Y_2 , and Y_3 are given in the table below.

Bearing Numbers	Figure ⁽¹⁾	Abutment and Fillet Dimensions (mm)				Constant e	Axial Load Factors		Mass (kg) approx.	Reference Bearing Numbers
		d_b	D_a	r_a max.	r_b max.		Y_2	Y_3		
280KV3801	1	294	356	2.5	1.5	0.37	2.7	1.8	93.7	—
280KV895	1	299	369	3	3	0.35	2.9	1.9	109	—
280KV80	1	305	393	3	3	0.40	2.5	1.7	109	—
280KV4202	1	306	385	3	3	0.42	2.4	1.6	117	—
280KV81	1	307	422	4	4	0.39	2.6	1.7	197	—
280KV4602	1	311	421	4	4	0.47	2.1	1.4	214	—
*285KV3851	1	300	355	3.3	1.5	0.43	2.3	1.6	78.8	LM654648DW-610-610D
*288KV4051	1	306	380	3.3	3.3	0.34	3.0	2.0	119	M255449D-410-410D
*292KV4251	1	318	395	3.3	6.4	0.32	3.2	2.1	124	EE330116D-166-167D
300KV4201	1	321	394	3	3	0.29	3.4	2.3	132	—
300KV895	1	322	394	3	3	0.40	2.5	1.7	138	—
300KV4302	1	319	401	2.5	2.5	0.47	2.1	1.4	129	—
300KV4301	1	319	403	2.5	2.5	0.35	2.9	1.9	141	—
300KV80	1	331	430	3	3	0.42	2.4	1.6	146	—
300KV4601	1	324	427	3	3	0.31	3.3	2.2	216	—
300KV4702A	1	327	436	3	3	0.33	3.0	2.0	181	—
300KV4703A	1	327	436	3	3	0.33	3.0	2.0	196	—
300KV4701	1	326	436	3	3	0.36	2.8	1.9	197	—
300KV81	1	331	459	4	4	0.39	2.6	1.7	254	—
300KV5001	1	331	458	4	4	0.35	2.9	1.9	300	—
*300KV4251	1	318	395	3.3	3.3	0.34	3.0	2.0	136	HM256849D-810-810D
*304KV4353	1	324	407	4.8	3.3	0.47	2.1	1.4	133	M757448DW-410-410D
*304KV4152	1	320	391	6.4	1.5	0.33	3.0	2.0	112	M257149DW-110-110D
*304KV4853	2	322	444	4.8	3.3	0.33	3.0	2.0	245	—
*304KV4852	2	313	444	4.8	3.3	0.37	2.7	1.8	223	—

Note * Bearings marked * are inch design.

⁽¹⁾ Refer to page **B 343**

FOUR-ROW TAPERED ROLLER BEARINGS

KV (TQ0) Type

Bore Diameter 304.800 – 335.000 mm

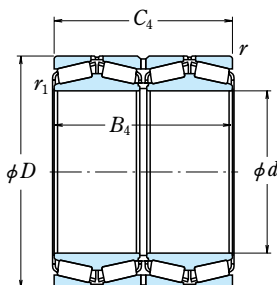

<i>d</i>	Boundary Dimensions (mm/inch)					Basic Load Ratings (kN) (kgf)			
	<i>D</i>	<i>B</i> ₄	<i>C</i> ₄	<i>r</i> ₁ min.	<i>r</i> min.	<i>C</i> _r	<i>C</i> _{0r}	<i>C</i> _r	<i>C</i> _{0r}
304.800 12.0000	495.300 19.5000	342.900 13.5000	349.250 13.7500	3.3	6.4	4 250	8 600	435 000	880 000
304.902 12.0040	412.648 16.2460	266.700 10.5000	266.700 10.5000	3.3	3.3	2 880	7 100	294 000	725 000
305.000 12.0079	438.048 17.2460	280.990 11.0626	279.400 11.0000	3.3	4.8	3 050	6 750	310 000	685 000
310	430	310	310	3	3	3 450	8 500	350 000	865 000
	455	222	222	4	4	2 520	5 100	257 000	520 000
	460	325	325	1.5	5	4 050	9 200	415 000	940 000
317.500 12.5000	422.275 16.6250	269.875 10.6250	269.875 10.6250	1.5	3.3	2 710	7 000	277 000	715 000
	447.675 17.6250	327.025 12.8750	327.025 12.8750	3.3	3.3	3 850	9 400	390 000	960 000
320	440	335	335	3	3	3 550	8 750	360 000	895 000
	460	325	325	4	4	3 850	8 650	390 000	885 000
	460	338	338	4	4	3 950	9 200	405 000	940 000
	480	254	254	4	4	3 150	6 250	320 000	640 000
	480 540	360 364	360 364	1.5 5	2.5 5	4 400 5 750	10 000 11 500	445 000 585 000	1 020 000 1 170 000
327.025 12.8750	482.600 19.0000	306.388 12.0625	311.150 12.2500	1.5	3.3	3 400	7 350	345 000	745 000
330	460	240	240	3	3	2 630	6 400	268 000	655 000
330.200 13.0000	508.000 20.0000	292.100 11.5000	292.100 11.5000	6.4	3.3	4 000	8 150	405 000	835 000
333.375 13.1250	469.900 18.5000	342.900 13.5000	342.900 13.5000	3.3	3.3	4 200	10 400	430 000	1 060 000
335.000 13.1890	460.000 18.1102	342.900 13.5000	342.900 13.5000	3.3	3.3	3 900	9 850	395 000	1 010 000

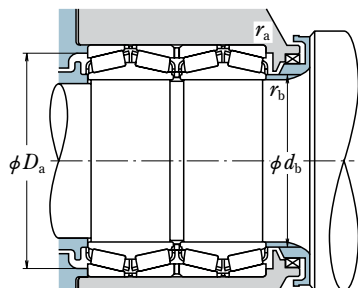

Dynamic Equivalent Load

$$P = XF_r + YF_a$$

$F_a/F_r \leq e$		$F_a/F_r > e$	
X	Y	X	Y
1	Y_3	0.67	Y_2

Static Equivalent Load

$$P_0 = F_r + Y_0 F_a$$

Where $Y_0 \doteq Y_3$

The values of e , Y_2 , and Y_3 are given in the table below.

Bearing Numbers	Figure ⁽¹⁾	Abutment and Fillet Dimensions (mm)				Constant e	Axial Load Factors		Mass (kg) approx.	Reference Bearing Numbers
		d_b	D_a	r_a max.	r_b max.		Y_2	Y_3		
*304KV4955	1	331	451	6.4	3.3	0.40	2.5	1.7	255	EE724121D-195-196D
*304KV4153	1	320	389	3.3	3.3	0.31	3.2	2.1	103	M257248DW-210-210D
*305KV4352	1	324	407	4.8	3.3	0.47	2.1	1.4	137	M757449DW-410-410D
310KV4301	1	327	403	2.5	2.5	0.34	2.9	2.0	135	—
310KV4501	1	336	427	3	3	0.39	2.6	1.7	117	—
310KV4601	1	329	426	4	1	0.41	2.4	1.6	186	—
*317KV4251	1	333	399	3.3	1.5	0.33	3.1	2.1	102	LM258648DW-610-610D
*317KV4451	1	335	418	3.3	3.3	0.33	3.0	2.0	162	HM259049D-010-010D
320KV89	1	337	413	2.5	2.5	0.33	3.0	2.0	146	—
320KV4601	1	340	429	3	3	0.42	2.4	1.6	170	—
320KV895	1	340	427	3	3	0.40	2.5	1.7	178	—
320KV80	1	346	448	3	3	0.39	2.6	1.7	156	—
320KV4802	1	339	444	2	1	0.47	2.1	1.4	227	—
320KV81	2	354	495	4	4	0.39	2.6	1.7	352	—
*327KV4851	1	347	447	3.3	1.5	0.39	2.6	1.7	185	EE526129D-190-191D
330KV4601	1	354	433	2.5	2.5	0.47	2.1	1.4	123	—
*330KV5051	1	360	473	3.3	6.4	0.40	2.5	1.7	214	—
*333KV4651	1	352	440	3.3	3.3	0.33	3.0	2.0	186	HM261049DW-010-010D
*335KV4651	1	351	429	3.3	3.3	0.39	2.6	1.7	167	—

Note * Bearings marked * are inch design.

⁽¹⁾ Refer to page **B 343**

FOUR-ROW TAPERED ROLLER BEARINGS

KV (TQO) Type

Bore Diameter 340 – 360 mm

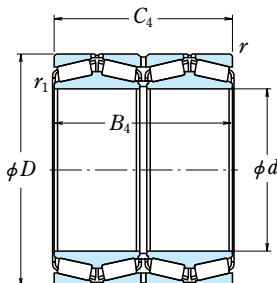

<i>d</i>	Boundary Dimensions (mm/inch)					Basic Load Ratings			
	<i>D</i>	<i>B</i> ₄	<i>C</i> ₄	<i>r</i> ₁ min.	<i>r</i> min.	(kN) <i>C</i> _r	(kN) <i>C</i> _{0r}	(kgf) <i>C</i> _r	(kgf) <i>C</i> _{0r}
340	460	254	254	3	3	2 630	6 400	268 000	655 000
	480	350	350	5	5	4 000	10 100	410 000	1 030 000
	520	278	278	6	5	4 050	8 250	415 000	840 000
	520	325	325	5	5	4 700	9 600	480 000	980 000
	580	392	392	5	5	6 150	12 200	625 000	1 250 000
341.312 13.4375	457.098 17.9960	254.000 10.0000	254.000 10.0000	1.5	3.3	2 930	7 250	299 000	740 000
343.052 13.5060	457.098 17.9960	254.000 10.0000	254.000 10.0000	1.5	3.3	2 930	7 250	299 000	740 000
346.075 13.6250	488.950 19.2500	358.775 14.1250	358.775 14.1250	3.3	3.3	4 550	11 200	465 000	1 140 000
347.662 13.6875	469.900 18.5000	260.350 10.2500	260.350 10.2500	1.5	3.3	3 100	7 500	315 000	765 000
	469.900 18.5000	292.100 11.5000	292.100 11.5000	3.3	3.3	3 400	8 400	345 000	855 000
355	490	316	316	2	4	4 100	9 750	415 000	995 000
355.600 14.0000	444.500 17.5000	241.300 9.5000	241.300 9.5000	1.5	3.3	2 270	6 650	232 000	675 000
	457.200 18.0000	252.412 9.9375	252.412 9.9375	1.5	3.3	2 790	7 550	285 000	770 000
	482.600 19.0000	265.112 10.4375	269.875 10.6250	1.5	3.3	3 050	7 250	310 000	740 000
	488.950 19.2500	317.500 12.5000	317.500 12.5000	1.5	3.3	4 100	9 750	415 000	995 000
	360	480	370	370	3	3	4 150	11 100	420 000
480		375	375	1	2	3 900	10 300	395 000	1 050 000
480		375	375	3	3	4 150	11 200	425 000	1 140 000
508		370	370	3	5	4 750	11 900	485 000	1 220 000
520		370	370	3	5	5 050	11 700	515 000	1 190 000
540		280	280	5	5	4 200	8 700	430 000	885 000
540		360	360	5	5	4 600	10 000	470 000	1 020 000
600		396	396	5	5	7 000	14 200	715 000	1 450 000
600		540	540	5	5	9 050	19 900	920 000	2 030 000

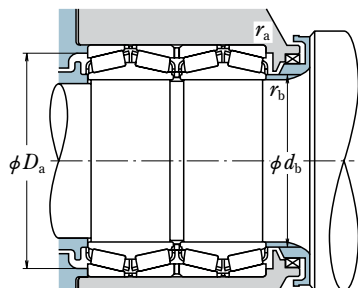

Dynamic Equivalent Load

$$P = XF_r + YF_a$$

$F_a/F_r \leq e$		$F_a/F_r > e$	
X	Y	X	Y
1	Y_3	0.67	Y_2

Static Equivalent Load

$$P_0 = F_r + Y_0 F_a$$

Where $Y_0 \doteq Y_3$

The values of e , Y_2 , and Y_3 are given in the table below.

Bearing Numbers	Figure ⁽¹⁾	Abutment and Fillet Dimensions (mm)				Constant e	Axial Load Factors			Mass (kg) approx.	Reference Bearing Numbers
		d_b	D_a	r_a max.	r_b max.		Y_2	Y_3			
340KV4601	1	359	433	2.5	2.5	0.47	2.1	1.4	118	—	
340KV895	1	364	449	4	4	0.29	3.4	2.3	198	—	
340KV80	1	382	484	4	5	0.39	2.6	1.7	213	—	
340KV5202	2	370	485	4	4	0.30	3.4	2.3	251	—	
340KV81	2	394	530	4	4	0.39	2.6	1.7	442	—	
*341KV4551	1	355	429	3.3	1.5	0.45	2.2	1.5	116	LM761648DW-610-610D	
*343KV4555	1	355	429	3.3	1.5	0.45	2.2	1.5	114	LM761649DW-610-610D	
*346KV4854	1	364	456	3.3	3.3	0.36	2.8	1.9	210	HM262749D-710-710D	
*347KV4652	1	365	444	3.3	1.5	0.33	3.0	2.0	129	LM262449DW-410-410D	
*347KV4651	1	366	444	3.3	3.3	0.33	3.0	2.0	144	M262449DW-410-410D	
355KV4901	1	373	462	3	1.5	0.33	3.0	2.0	177	—	
*355KV4451	1	370	422	3.3	1.5	0.31	3.3	2.2	84.9	L163149D-110-110D	
*355KV4552	1	370	435	3.3	1.5	0.32	3.2	2.1	104	LM263149D-110-110D	
*355KV4852	1	372	452	3.3	1.5	0.47	2.1	1.4	140	LM763449DW-410-410D	
*355KV4853	1	373	462	3.3	1.5	0.33	3.0	2.0	174	M263349D-310-310D	
360KV4801	1	376	452	2.5	2.5	0.33	3.0	2.0	181	—	
360KV4803	1	373	453	2	1	0.40	2.5	1.7	179	—	
360KV89	1	375	452	2.5	2.5	0.33	3.0	2.0	183	—	
360KV895	1	379	473	4	2.5	0.40	2.5	1.7	235	—	
360KV5201	1	381	485	4	2.5	0.33	3.1	2.1	256	—	
360KV80	2	391	505	4	4	0.39	2.6	1.7	229	—	
360KV5401	1	386	498	4	4	0.40	2.5	1.7	278	—	
360KV81	2	398	551	4	4	0.39	2.6	1.7	465	—	
360KV6001	2	395	547	4	4	0.42	2.4	1.6	628	—	

Note * Bearings marked * are inch design.

⁽¹⁾ Refer to page **B 343**

FOUR-ROW TAPERED ROLLER BEARINGS

KV (TQO) Type

Bore Diameter 368.300 – 406.400 mm

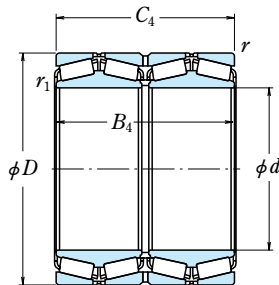

<i>d</i>	Boundary Dimensions (mm/inch)					Basic Load Ratings (kN) (kgf)			
	<i>D</i>	<i>B</i> ₄	<i>C</i> ₄	<i>r</i> ₁ min.	<i>r</i> min.	<i>C</i> _r	<i>C</i> _{0r}	<i>C</i> _r	<i>C</i> _{0r}
368.300 14.5000	523.875 20.6250	382.588 15.0625	382.588 15.0625	3.3	6.4	5 900	14 900	600 000	1 520 000
	596.900 23.5000	342.900 13.5000	342.900 13.5000	6.4	6.4	5 700	11 500	585 000	1 170 000
370	490	292	292	3	3	3 450	9 300	350 000	950 000
374.650 14.7500	501.650 19.7500	250.825 9.8750	260.350 10.2500	1.5	3.3	2 750	6 600	280 000	675 000
	380	520	350	350	4	4	4 250	11 000	435 000
520		400	400	2.5	4	5 050	12 900	515 000	1 320 000
536		390	390	5	5	5 200	13 100	530 000	1 330 000
560		282	282	5	5	4 200	9 050	430 000	920 000
560		285	285	5	5	4 500	9 550	455 000	975 000
560		360	360	1.5	5	5 200	11 200	530 000	1 140 000
620	400	400	5	5	7 150	14 800	730 000	1 510 000	
384.175 15.1250	546.100 21.5000	400.050 15.7500	400.050 15.7500	3.3	6.4	6 700	16 600	680 000	1 700 000
	385.762 15.1875	514.350 20.2500	317.500 12.5000	317.500 12.5000	3.3	3.3	4 050	10 400	415 000
390		510	350	350	1.5	3	4 250	11 700	430 000
393.700 15.5000	546.100 21.5000	288.925 11.3750	288.925 11.3750	1.5	6.4	3 450	8 550	350 000	875 000
	395	545	269.2	288.7	4	7.5	3 450	8 550	350 000
400	564	412	412	5	5	5 500	13 800	560 000	1 400 000
	590	304	304	5	5	4 600	10 000	470 000	1 020 000
	600	308	308	5	5	5 150	11 100	525 000	1 140 000
	650	414	414	6	6	7 800	16 600	795 000	1 690 000
406.400 16.0000	546.100 21.5000	268.288 10.5625	288.925 11.3750	3.3	6.4	3 550	8 600	360 000	875 000
	546.100 21.5000	288.925 11.3750	288.925 11.3750	1.5	6.4	3 450	8 550	350 000	875 000
	546.100 21.5000	330.000 12.9921	330.000 12.9921	3.3	6.4	4 500	11 500	460 000	1 170 000

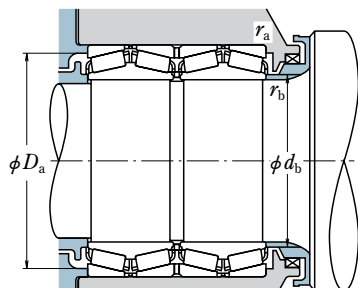

Dynamic Equivalent Load

$$P = XF_r + YF_a$$

$F_a/F_r \leq e$		$F_a/F_r > e$	
X	Y	X	Y
1	Y_3	0.67	Y_2

Static Equivalent Load

$$P_0 = F_r + Y_0 F_a$$

Where $Y_0 \doteq Y_3$

The values of e , Y_2 , and Y_3 are given in the table below.

Bearing Numbers	Figure ⁽¹⁾	Abutment and Fillet Dimensions (mm)				Constant e	Axial Load Factors		Mass (kg) approx.	Reference Bearing Numbers
		d_b	D_a	r_a max.	r_b max.		Y_2	Y_3		
*368KV5251	2	389	487	6.4	3.3	0.33	3.0	2.0	274	HM265049DW-010-010D
*368KV5951	2	407	549	6.4	6.4	0.41	2.4	1.6	385	EE181455D-2350-2351D
370KV4901	1	388	463	2.5	2.5	0.34	2.9	2.0	151	—
*374KV5051	1	393	472	3.3	1.5	0.44	2.3	1.5	141	LM765149D-110-110D
380KV5201	1	403	488	3	3	0.31	3.3	2.2	219	—
380KV5202	1	398	489	3	2	0.35	2.9	1.9	243	—
380KV895	1	401	499	4	4	0.40	2.5	1.7	272	—
380KV80	2	418	523	4	4	0.42	2.4	1.6	244	—
380KV5603	2	412	525	4	4	0.37	2.7	1.8	246	—
380KV5605	2	402	523	4	1.5	0.35	2.9	1.9	298	—
380KV81	2	416	571	4	4	0.40	2.5	1.7	490	—
*384KV5452	2	406	509	6.4	3.3	0.33	3.0	2.0	309	HM266449D-410-410D
*385KV5151	1	403	485	3.3	3.3	0.42	2.4	1.6	181	LM665949DW-910-910D
390KV5101	1	405	483	2.5	1.5	0.33	3.0	2.0	188	—
*393KV5452	1	419	511	6.4	1.5	0.47	2.1	1.4	205	LM767745D-710-710D
395KV5401	1	422	511	6	3	0.47	2.1	1.4	196	—
400KV895	1	424	525	4	4	0.40	2.5	1.7	315	—
400KV5901	2	431	551	4	4	0.42	2.4	1.6	287	—
400KV80	2	435	561	4	4	0.37	2.7	1.8	316	—
400KV81	2	452	595	5	5	0.39	2.6	1.7	555	—
*406KV5453	1	424	507	6.4	3.3	0.62	1.6	1.1	178	EE234161D-215-216D
*406KV5455	1	425	511	6.4	1.5	0.47	2.1	1.4	186	LM767749DW-710-710D
*406KV5458	1	424	512	6.4	3.3	0.41	2.5	1.7	214	—

Note * Bearings marked * are inch design.

⁽¹⁾ Refer to page **B 343**

FOUR-ROW TAPERED ROLLER BEARINGS

KV (TQO) Type

Bore Diameter 406.400 – 450 mm

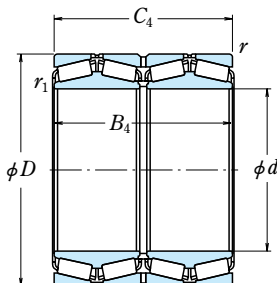

Boundary Dimensions (mm/inch)						Basic Load Ratings (kN) (kgf)			
d	D	B_4	C_4	r_1 min.	r min.	C_r	C_{0r}	C_r	C_{0r}
406.400 16.0000	565.150 22.2500	381.000 15.0000	381.000 15.0000	1.5	3.3	6 050	15 300	615 000	1 560 000
	590.550 23.2500	400.050 15.7500	400.050 15.7500	3.3	6.4	5 500	13 200	560 000	1 350 000
409.575 16.1250	546.100 21.5000	334.962 13.1875	334.962 13.1875	1.5	6.4	4 550	11 900	465 000	1 210 000
	415.925 16.3750	590.550 23.2500	434.975 17.1250	434.975 17.1250	3.3	6.4	7 500	19 500	765 000
416	574	480	480	4	4	6 500	17 100	665 000	1 740 000
420	560	437	437	3	5	5 400	14 500	550 000	1 480 000
	592	432	432	5	5	5 850	14 700	595 000	1 500 000
	620	312	312	5	5	5 450	12 100	555 000	1 240 000
	620	355	355	5	5	5 800	13 100	590 000	1 340 000
	650	460	460	6	6	7 700	17 200	785 000	1 760 000
430	700	460	460	6	6	9 350	20 300	955 000	2 070 000
	570	336	336	2	6	4 600	11 900	470 000	1 210 000
	431.800 17.0000	571.500 22.5000	279.400 11.0000	279.400 11.0000	1.5	3.3	3 700	9 400	375 000
571.500 22.5000		336.550 13.2500	336.550 13.2500	1.5	6.4	4 500	11 900	460 000	1 210 000
431.902 17.0040	635.000 25.0000	355.600 14.0000	355.600 14.0000	6.4	6.4	6 400	14 500	655 000	1 480 000
	685.698 26.9960	533.273 20.9950	533.400 21.0000	6.4	6.4	10 400	22 800	1 060 000	2 330 000
440	620	454	454	6	6	7 600	20 200	775 000	2 060 000
	635	470	470	2.5	5	8 650	21 800	880 000	2 230 000
	650	326	326	6	6	5 600	12 400	575 000	1 270 000
	720	465	465	6	6	9 550	19 800	975 000	2 010 000
447.675 17.6250	635.000 25.0000	463.550 18.2500	463.550 18.2500	3.3	6.4	6 500	17 300	665 000	1 770 000
	448	635	464	464	2.5	5	8 350	21 600	855 000
450		580	450	450	1.5	6	5 000	14 300	510 000
	595	368	368	4	4	5 050	13 700	510 000	1 400 000

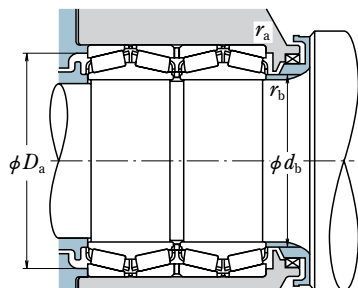

Dynamic Equivalent Load

$$P = XF_r + YF_a$$

$F_a/F_r \leq e$		$F_a/F_r > e$	
X	Y	X	Y
1	Y_3	0.67	Y_2

Static Equivalent Load

$$P_0 = F_r + Y_0 F_a$$

Where $Y_0 \doteq Y_3$

The values of e , Y_2 , and Y_3 are given in the table below.

Bearing Numbers	Figure ⁽¹⁾	Abutment and Fillet Dimensions (mm)				Constant e	Axial Load Factors		Mass (kg) approx.	Reference Bearing Numbers
		d_b	D_a	r_a max.	r_b max.		Y_2	Y_3		
*406KV5656	2	427	532	3.3	1.5	0.33	3.0	2.0	301	M267949D-910-910XD
*406KV5951	1	432	548	6.4	3.3	0.33	3.1	2.1	357	EE833161D-232-233D
*409KV5451	1	426	513	6.4	1.5	0.42	2.4	1.6	213	M667947D-910-910D
*415KV5951	2	439	550	6.4	3.3	0.33	3.0	2.0	395	M268749D-710-710D
416KV5702	2	440	542	3	3	0.28	3.6	2.4	366	—
420KV5601	1	440	529	4	2.5	0.31	3.3	2.2	284	—
420KV895	1	444	550	4	4	0.41	2.5	1.7	363	—
420KV80	2	463	578	4	4	0.39	2.6	1.7	331	—
420KV6202	1	453	581	4	4	0.39	2.6	1.7	364	—
420KV6501	1	453	600	5	5	0.40	2.5	1.7	547	—
420KV81	2	485	642	5	5	0.39	2.6	1.7	736	—
430KV5701	1	455	534	5	1.5	0.35	2.9	1.9	233	—
*431KV5753	1	448	539	3.3	1.5	0.55	1.8	1.2	190	LM869449D-410-410D
*431KV5755	1	449	537	6.4	1.5	0.42	2.4	1.6	241	LM769349D-310-310D
*431KV6351	2	468	595	6.4	6.4	0.32	3.1	2.1	392	EE931170D-250-251XD
*431KV6851	2	468	630	6.4	6.4	0.40	2.5	1.7	761	EE328172D-269-268D
440KV895	2	465	576	5	5	0.40	2.5	1.7	442	—
440KV6301	2	465	593	4	2	0.33	3.0	2.0	509	—
440KV80	1	488	606	5	5	0.39	2.6	1.7	381	—
440KV81	1	497	665	5	5	0.39	2.6	1.7	771	—
*447KV6351	1	475	591	6.4	3.3	0.33	3.0	2.0	471	M270749DW-710-710D
448KV6301	1	472	594	4	2	0.33	3.0	2.0	485	—
450KV5801	1	466	549	5	1	0.31	3.2	2.2	282	—
450KV5901	1	473	563	3	3	0.33	3.0	2.0	273	—

Note * Bearings marked * are inch design.

(1) Refer to page **B 343**

FOUR-ROW TAPERED ROLLER BEARINGS

KV (TQO) Type

Bore Diameter 457.200 – 490 mm

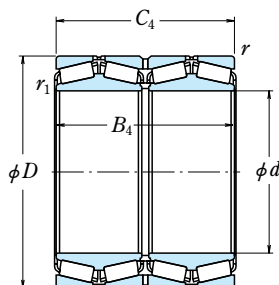

Boundary Dimensions (mm/inch)						Basic Load Ratings (kN) (kgf)			
d	D	B_4	C_4	r_1 min.	r min.	C_r	C_{0r}	C_r	C_{0r}
457.200 18.0000	596.900 23.5000	276.225 10.8750	279.400 11.0000	1.5	3.3	3 850	10 000	390 000	1 020 000
	596.900 23.5000	276.225 10.8750	279.400 11.0000	1.5	3.3	4 100	10 300	420 000	1 050 000
460	586	266	266	3	3	3 550	9 300	360 000	945 000
	590	360	360	3	3	4 900	14 100	500 000	1 440 000
	615	360	360	3	5	4 800	12 800	490 000	1 310 000
	625	421	421	3	9	6 550	17 600	670 000	1 800 000
	650	474	474	6	6	7 200	18 500	735 000	1 890 000
	680	338	338	6	6	6 500	15 100	660 000	1 540 000
760	494	494	7.5	7.5	10 700	23 300	1 090 000	2 380 000	
475	660	450	450	3	5	6 650	17 900	680 000	1 820 000
479.425 18.8750	679.450 26.7500	495.300 19.5000	495.300 19.5000	3.3	6.4	9 600	25 500	980 000	2 600 000
	480	678	494	494	6	6	9 600	25 500	980 000
700		342	342	6	6	6 400	14 300	655 000	1 460 000
790		510	510	7.5	7.5	10 500	21 500	1 070 000	2 190 000
482.600 19.0000	615.950 24.2500	330.200 13.0000	330.200 13.0000	3.3	6.4	4 750	13 800	485 000	1 410 000
	615.950 24.2500	330.200 13.0000	330.200 13.0000	6.5	6.4	4 750	13 800	485 000	1 410 000
	635.000 25.0000	421.000 16.5748	421.000 16.5748	3.0	6.4	6 800	19 100	695 000	1 950 000
	647.700 25.5000	417.512 16.4375	417.512 16.4375	3.3	6.4	7 100	19 400	725 000	1 970 000
488.950 19.2500	622.300 24.5000	365.125 14.3750	365.125 14.3750	3.8	6.4	4 900	14 400	500 000	1 470 000
	660.400 26.0000	365.125 14.3750	361.950 14.2500	8.0	6.4	6 550	16 900	670 000	1 720 000
489.026 19.2530	634.873 24.9950	320.675 12.6250	320.675 12.6250	3.3	3.3	4 700	12 700	480 000	1 300 000
	490	625	385	385	3	4	5 550	16 200	565 000

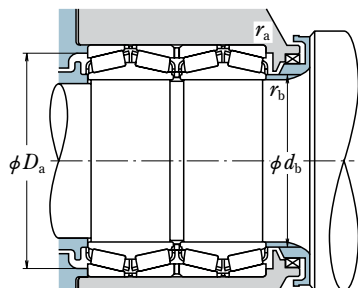

Dynamic Equivalent Load

$$P = XF_r + YF_a$$

$F_a/F_r \leq e$		$F_a/F_r > e$	
X	Y	X	Y
1	Y_3	0.67	Y_2

Static Equivalent Load

$$P_0 = F_r + Y_0 F_a$$

Where $Y_0 \doteq Y_3$

The values of e , Y_2 , and Y_3 are given in the table below.

Bearing Numbers	Figure ⁽¹⁾	Abutment and Fillet Dimensions (mm)				Constant e	Axial Load Factors		Mass (kg) approx.	Reference Bearing Numbers
		d_b	D_a	r_a max.	r_b max.		Y_2	Y_3		
*457KV5952	1	476	566	3.3	1.5	0.47	2.1	1.4	201	L770847DW-810-810D
*457KV5956	1	473	567	3.3	1.5	0.47	2.1	1.4	197	—
460KV5801	1	478	559	2.5	2.5	0.46	2.2	1.5	168	—
460KV5901	1	481	564	2.5	2.5	0.28	3.6	2.4	242	—
460KV6101	1	481	577	4	2.5	0.45	2.2	1.5	289	—
460KV6201	2	482	584	9	3	0.33	3.0	2.0	381	M271149D-110-110D
460KV895	1	485	606	5	5	0.40	2.5	1.7	477	—
460KV80	2	513	635	5	5	0.40	2.5	1.7	433	—
460KV81	2	530	698	6	6	0.39	2.6	1.7	923	—
475KV6601	1	501	618	4	2.5	0.37	2.7	1.8	463	—
*479KV6751	2	506	635	6.4	3.3	0.34	3.0	2.0	595	M272749DW-710-710D
480KV895	2	509	634	5	5	0.34	3.0	2.0	586	—
480KV80	2	527	655	5	5	0.39	2.6	1.7	453	—
480KV81	2	550	725	6	6	0.39	2.6	1.7	1 030	—
*482KV6152	1	501	582	6.4	3.3	0.37	2.7	1.8	242	LM272249D-210-210D
*482KV6152a	1	504	582	6.4	6.5	0.37	2.7	1.8	242	LM272248DW-210-210D
*482KV6351	2	502	599	6.4	3.0	0.33	3.0	2.0	355	M272449D-410-410D
*482KV6451	1	505	609	6.4	3.3	0.37	2.7	1.8	400	M272647DW-610-610D
*488KV6251	1	508	589	6.4	3.8	0.29	3.4	2.3	265	—
*488KV6652	2	519	625	6.4	8.0	0.31	3.3	2.2	365	EE640193D-260-261D
*489KV6351	1	508	602	3.3	3.3	0.47	2.1	1.4	256	LM772749DW-710-710D
490KV6201	2	508	595	3	2.5	0.32	3.2	2.1	284	—

Note * Bearings marked * are inch design.

⁽¹⁾ Refer to page **B 343**

FOUR-ROW TAPERED ROLLER BEARINGS

KV (TQO) Type

Bore Diameter 500 – 535 mm

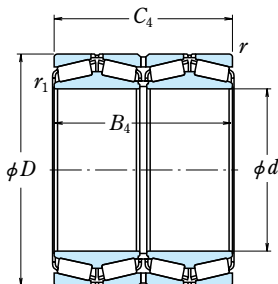

<i>d</i>	Boundary Dimensions (mm/inch)					Basic Load Ratings (kN) (kgf)			
	<i>D</i>	<i>B</i> ₄	<i>C</i> ₄	<i>r</i> ₁ min.	<i>r</i> min.	<i>C</i> _r	<i>C</i> _{0r}	<i>C</i> _r	<i>C</i> _{0r}
500	670	515	515	5	5	8 400	24 600	860 000	2 510 000
	705	515	515	6	6	9 700	26 600	990 000	2 710 000
	710	425	430	5	5	8 050	19 500	820 000	1 980 000
	720	348	348	6	6	6 500	14 800	665 000	1 510 000
	720	400	400	5	5	7 950	18 700	810 000	1 900 000
	729.805	440	440	6	6	9 300	22 200	950 000	2 270 000
	830	540	540	7.5	7.5	12 500	26 400	1 280 000	2 690 000
500.25	640	450	450	4	4	6 750	19 900	690 000	2 030 000
501.650 19.7500	673.100	400.050	387.350	6.4	6.4	6 600	18 000	675 000	1 830 000
	711.200	520.700	520.700	3.3	6.4	9 900	26 600	1 010 000	2 710 000
	28.0000	20.5000	20.5000						
508	749.3	355.6	355.6	6	6	6 900	15 400	705 000	1 570 000
	762	420	420	6	2	8 550	19 100	875 000	1 950 000
508.000	762.000	463.550	463.550	6.4	6.4	9 500	22 700	970 000	2 320 000
	20.0000	30.0000	18.2500	18.2500					
509.948	654.924	377.000	379.000	1.5	6.4	6 100	17 600	620 000	1 800 000
	20.0767	25.7844	14.8425	14.9213					
514.350	673.100	422.275	422.275	3.3	6.4	6 700	19 000	685 000	1 930 000
	20.2500	26.5000	16.6250	16.6250					
	736.600	290.104	317.505	3.3	3.3	5 550	13 600	565 000	1 380 000
	29.0000	11.4214	12.5002						
519.112	736.600	536.575	536.575	6.4	6.4	10 000	26 700	1 020 000	2 720 000
	20.4375	29.0000	21.1250	21.1250					
520	735	535	535	6	6	10 000	26 700	1 020 000	2 720 000
530	730	535	540	5	5	10 000	26 500	1 020 000	2 710 000
	750	480	480	6	6	9 550	24 900	975 000	2 540 000
	750	550	550	6	6	10 500	28 000	1 070 000	2 860 000
	780	385	385	6	6	8 300	18 700	845 000	1 900 000
	780	570	570	6	6	12 100	30 000	1 230 000	3 100 000
	870	560	560	7.5	7.5	13 600	28 900	1 390 000	2 950 000
535	760	560	560	6	6	11 100	30 000	1 130 000	3 050 000

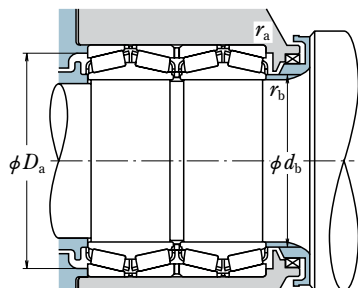

Dynamic Equivalent Load

$$P = XF_r + YF_a$$

$F_a/F_r \leq e$		$F_a/F_r > e$	
X	Y	X	Y
1	Y_3	0.67	Y_2

Static Equivalent Load

$$P_0 = F_r + Y_0 F_a$$

Where $Y_0 \doteq Y_3$

The values of e , Y_2 , and Y_3 are given in the table below.

Bearing Numbers	Figure ⁽¹⁾	Abutment and Fillet Dimensions (mm)				Constant e	Axial Load Factors		Mass (kg) approx.	Reference Bearing Numbers
		d_b	D_a	r_a max.	r_b max.		Y_2	Y_3		
500KV89	2	525	630	4	4	0.33	3.0	2.0	518	—
500KV895	2	530	658	5	5	0.37	2.7	1.8	654	—
500KV7101	2	527	666	4	4	0.37	2.7	1.8	530	—
500KV80	2	534	675	5	5	0.40	2.5	1.7	476	—
500KV7202	2	534	676	4	4	0.33	3.0	2.0	548	—
500KV7301	2	536	683	5	5	0.33	3.0	2.0	639	—
500KV81	2	570	760	6	6	0.39	2.6	1.7	1 210	—
500KV6403A	2M	520	609	3	3	0.28	3.6	2.4	366	—
*501KV6751	2	530	635	6.4	6.4	0.31	3.2	2.1	400	EE641198D-265-266D
*501KV7151	2	532	664	6.4	3.3	0.33	3.0	2.0	678	M274149DW-110-110D
508KV7401	2	548	702	5	5	0.36	2.8	1.9	548	—
508KV7601	2	548	717	2	5	0.36	2.8	1.9	693	—
*508KV7653	2	551	710	6.4	6.4	0.38	2.6	1.8	765	EE531201D-300-301XD
*509KV6552	2	526	618	6.4	1.5	0.41	2.4	1.6	319	—
*514KV6751	1	535	636	6.4	3.3	0.31	3.2	2.1	397	LM274449DW-410-410D
*514KV7352	2	560	685	3.3	3.3	0.48	2.1	1.4	431	982025D-900-901D
*519KV7351	2	553	687	6.4	6.4	0.33	3.0	2.0	740	M275349D-310-310D
520KV895	2	553	687	5	5	0.33	3.0	2.0	731	—
530KV7301A	1	557	688	4	4	0.33	3.0	2.0	657	—
530KV7501	2	564	703	5	5	0.33	3.0	2.0	694	—
530KV895	2	563	700	5	5	0.33	3.0	2.0	788	—
530KV80	2	582	730	5	5	0.37	2.7	1.8	644	—
530KV7801	1	566	728	5	5	0.33	3.0	2.0	956	—
530KV81	1	578	800	6	6	0.39	2.6	1.7	1 360	—
535KV895	2	568	710	5	5	0.33	3.0	2.0	833	—

Note * Bearings marked * are inch design.

⁽¹⁾ Refer to page **B 343**

The letter "M" indicates bearing for oil mist lubrication.

FOUR-ROW TAPERED ROLLER BEARINGS

KV (TQO) Type

Bore Diameter 536.575 – 585.788 mm

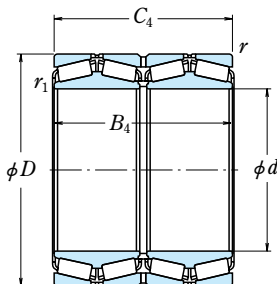

<i>d</i>	Boundary Dimensions (mm/inch)					Basic Load Ratings (kN) (kgf)			
	<i>D</i>	<i>B</i> ₄	<i>C</i> ₄	<i>r</i> ₁ min.	<i>r</i> min.	<i>C</i> _r	<i>C</i> _{0r}	<i>C</i> _r	<i>C</i> _{0r}
536.575 21.1250	761.873 29.9950	558.800 22.0000	558.800 22.0000	3.3	6.4	11 100	30 000	1 130 000	3 050 000
555.625 21.8750	698.500 27.5000	349.250 13.7500	349.250 13.7500	3.3	6.4	5 150	16 000	525 000	1 640 000
558.75	965.3	495.3	495.3	spec.	7.5	12 900	28 600	1 320 000	2 910 000
558.800 22.0000	736.600 29.0000	322.262 12.6875	322.262 12.6875	3.3	6.4	6 050	15 800	620 000	1 620 000
	736.600 29.0000	322.262 12.6875	322.262 12.6875	3.3	6.4	5 950	15 500	610 000	1 580 000
	736.600 29.0000	409.575 16.1250	409.575 16.1250	3.3	6.4	7 050	19 400	720 000	1 980 000
	736.600 29.0000	430.000 16.9291	430.000 16.9291	3.3	6.4	8 450	23 600	860 000	2 400 000
	736.600 29.0000	450.000 17.7165	450.000 17.7165	3.3	6.4	8 950	25 300	910 000	2 580 000
	736.600 29.0000	455.600 17.9370	457.200 18.0000	3.3	6.4	8 950	25 300	910 000	2 580 000
	560	805	590	590	6	6	13 700	37 000	1 400 000
820		405	405	6	6	9 100	20 600	930 000	2 100 000
920		575	575	7.5	7.5	14 600	31 000	1 480 000	3 150 000
920		618	618	7.5	7.5	16 000	34 000	1 630 000	3 500 000
570	780	515	515	6	6	10 600	29 700	1 090 000	3 050 000
	810	590	590	6	6	12 700	35 000	1 300 000	3 550 000
571.500 22.5000	812.800 32.0000	593.725 23.3750	593.725 23.3750	3.3	6.4	13 700	37 000	1 400 000	3 800 000
	584.200 23.0000	762.000 30.0000	396.875 15.6250	401.638 15.8125	3.3	6.4	7 250	20 800	740 000
901.573 35.4950		523.080 20.5937	539.750 21.2500	3.3	9.7	13 100	29 100	1 330 000	2 970 000
585.788 23.0625	771.525 30.3750	479.425 18.8750	479.425 18.8750	3.3	6.4	9 750	28 200	995 000	2 870 000

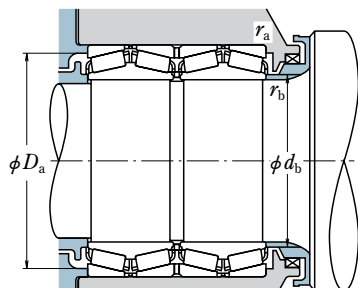

Dynamic Equivalent Load

$$P = XF_r + YF_a$$

$F_a/F_r \leq e$		$F_a/F_r > e$	
X	Y	X	Y
1	Y_3	0.67	Y_2

Static Equivalent Load

$$P_0 = F_r + Y_0 F_a$$

Where $Y_0 \doteq Y_3$

The values of e , Y_2 , and Y_3 are given in the table below.

Bearing Numbers	Figure ⁽¹⁾	Abutment and Fillet Dimensions (mm)				Constant e	Axial Load Factors		Mass (kg) approx.	Reference Bearing Numbers
		d_b	D_a	r_a max.	r_b max.		Y_2	Y_3		
*536KV7651	2	567	710	6.4	3.3	0.33	3.0	2.0	836	M276449DW-410-410D
*555KV6951	1	577	664	6.4	3.3	0.33	3.0	2.0	311	—
558KV9601	2	629	879	6	—	0.32	3.2	2.1	1 590	—
*558KV7351	2	585	699	6.4	3.3	0.34	2.9	2.0	379	EE843221D-290-291D
*558KV7357	1	584	699	6.4	3.3	0.34	2.9	2.0	369	EE843220DW-290-291D
*558KV7352B	2	582	696	6.4	3.3	0.35	2.9	1.9	457	—
*558KV7356	1	581	697	6.4	3.3	0.35	2.9	1.9	492	—
*558KV7354	2	581	696	6.4	3.3	0.35	2.9	1.9	531	—
*558KV7355	2	581	696	6.4	3.3	0.35	2.9	1.9	536	LM277149DA-110-110D
560KV895	2	599	756	5	5	0.33	3.0	2.0	1 030	—
560KV80	2	613	768	5	5	0.37	2.7	1.8	742	—
560KV81	2	635	845	6	6	0.39	2.6	1.7	1 560	—
560KV9201	2	612	850	6	6	0.40	2.5	1.7	1 670	—
570KV7801	2	600	734	5	5	0.36	2.8	1.9	752	—
570KV895	2	615	750	5	5	0.33	3.0	2.0	998	—
*571KV8151F	2	603	759	6.4	3.3	0.33	3.0	2.0	1 020	M278749DW-710-710D
*584KV7651	2	615	717	6.4	3.3	0.47	2.1	1.4	488	LM778549DW-510-510D
*584KV9051	2	631	836	9.7	3.3	0.33	3.0	2.0	1 280	EE665231D-355-356D
*585KV7752	2	609	729	6.4	3.3	0.33	3.0	2.0	624	LM278849D-810-810D

Note * Bearings marked * are inch design.

⁽¹⁾ Refer to page **B 343**

FOUR-ROW TAPERED ROLLER BEARINGS

KV (TQO) Type

Bore Diameter 595 – 657.225 mm

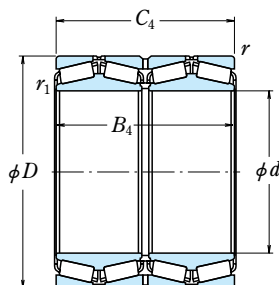

<i>d</i>	Boundary Dimensions (mm/inch)					Basic Load Ratings			
	<i>D</i>	<i>B</i> ₄	<i>C</i> ₄	<i>r</i> ₁ min.	<i>r</i> min.	(kN) <i>C</i> _r	<i>C</i> _{0r}	(kgf) <i>C</i> _r	<i>C</i> _{0r}
595	845	615	615	6	6	13 700	38 000	1 400 000	3 850 000
595.312 23.4375	844.550 33.2500	615.950 24.2500	615.950 24.2500	3.3	6.4	13 300	36 500	1 360 000	3 750 000
600	855	620	620	6	6	13 900	38 500	1 420 000	3 900 000
	870	415	415	6	6	9 250	21 700	940 000	2 210 000
	980	615	615	7.5	7.5	16 600	36 500	1 690 000	3 750 000
603.250 23.7500	857.250 33.7500	622.300 24.5000	622.300 24.5000	3.3	6.4	13 900	37 000	1 420 000	3 800 000
609.600 24.0000	787.400 31.0000	361.950 14.2500	361.950 14.2500	3.3	6.4	6 700	18 700	680 000	1 910 000
	813.562 32.0300	479.425 18.8750	479.425 18.8750	3.3	6.4	9 950	28 200	1 010 000	2 880 000
	863.600 34.0000	660.400 26.0000	660.400 26.0000	3.3	6.4	14 700	41 000	1 500 000	4 200 000
611.500 24.0748	832.800 32.7874	593.720 23.3748	593.720 23.3748	3.3	6.4	13 300	38 000	1 360 000	3 850 000
630	890	650	650	7.5	7.5	15 400	43 000	1 570 000	4 400 000
	920	440	440	7.5	7.5	10 600	25 500	1 090 000	2 600 000
	920	457.2	457.2	4	3	10 600	25 400	1 080 000	2 590 000
	920	600	600	7.5	7.5	15 000	38 500	1 530 000	3 950 000
	1 030	645	645	7.5	7.5	18 400	42 500	1 880 000	4 350 000
635	900	655	655	7.5	7.5	15 800	44 500	1 610 000	4 550 000
	900	660	660	5	6	15 500	43 500	1 580 000	4 400 000
635.000 25.0000	901.700 35.5000	654.050 25.7500	654.050 25.7500	3.3	6.4	15 500	43 500	1 580 000	4 400 000
646.112 25.4375	857.250 33.7500	542.925 21.3750	542.925 21.3750	3.3	6.4	11 500	34 500	1 170 000	3 550 000
650	1 030	560	560	7.5	7.5	15 700	35 500	1 600 000	3 650 000
655	935	675	675	7.5	7.5	16 600	45 000	1 690 000	4 600 000
657.225 25.8750	933.450 36.7500	676.275 26.6250	676.275 26.6250	3.3	6.4	16 600	45 000	1 690 000	4 600 000

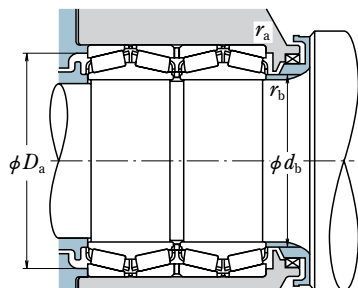

Dynamic Equivalent Load

$$P = XF_r + YF_a$$

$F_a/F_r \leq e$		$F_a/F_r > e$	
X	Y	X	Y
1	Y_3	0.67	Y_2

Static Equivalent Load

$$P_0 = F_r + Y_0 F_a$$

Where $Y_0 \doteq Y_3$

The values of e , Y_2 , and Y_3 are given in the table below.

Bearing Numbers	Figure ⁽¹⁾	Abutment and Fillet Dimensions (mm)				Constant e	Axial Load Factors		Mass (kg) approx.	Reference Bearing Numbers
		d_b	D_a	r_a max.	r_b max.		Y_2	Y_3		
595KV895	2	633	791	5	5	0.33	3.0	2.0	1 140	—
*595KV8451	2	630	790	6.4	3.3	0.33	3.0	2.0	1 140	M280049D-010-010D
600KV895	2	643	791	5	5	0.33	3.0	2.0	1 170	—
600KV80A	2	643	817	5	5	0.37	2.7	1.8	842	—
600KV81	2	680	905	6	6	0.39	2.6	1.7	1 890	—
*603KV8551	2	635	802	6.4	3.3	0.33	3.0	2.0	1 190	M280249D-210-210XD
*609KV7851A	2	633	744	6.4	3.3	0.48	2.1	1.4	454	EE649241D-310-311D
*609KV8152	2	637	768	6.4	3.3	0.33	3.0	2.0	718	—
*609KV8651	2	648	807	6.4	3.3	0.33	3.0	2.0	1 260	M280349D-310-310D
*611KV8351	2	639	783	6.4	3.3	0.33	3.0	2.0	981	—
630KV895	2	674	825	6	6	0.33	3.0	2.0	1 310	—
630KV80	2	690	860	6	6	0.37	2.7	1.8	1 010	—
630KV9201	2	676	865	2.5	3	0.37	2.7	1.8	1 060	—
630KV9202	1	670	858	6	6	0.36	2.8	1.9	1 360	—
630KV81	2	720	945	6	6	0.37	2.7	1.8	2 190	—
635KV895	2	695	840	6	6	0.33	3.0	2.0	1 360	—
635KV9001	2	673	843	5	4	0.33	3.0	2.0	1 380	—
*635KV9051	2	671	843	6.4	3.3	0.33	3.0	2.0	1 380	M281049D-010-010D
*646KV8551	2	678	810	6.4	3.3	0.33	3.0	2.0	880	LM281049DW-010-010D
650KV1001	2	715	958	6	6	0.31	3.2	2.1	1 830	—
655KV895	2	705	870	6	6	0.33	3.0	2.0	1 530	—
*657KV9351	2	693	875	6.4	3.3	0.33	3.0	2.0	1 520	M281649D-610-610D

Note * Bearings marked * are inch design.

⁽¹⁾ Refer to page **B 343**

FOUR-ROW TAPERED ROLLER BEARINGS

KV (TQO) Type

Bore Diameter 660 – 711.200 mm

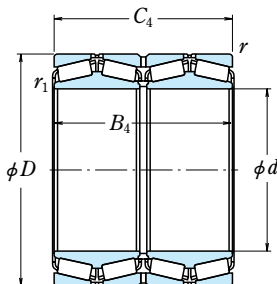

Boundary Dimensions (mm/inch)						Basic Load Ratings (kN) (kgf)			
d	D	B_4	C_4	r_1 min.	r min.	C_r	C_{0r}	C_r	C_{0r}
660	1 070	642	642	7.5	7.5	19 000	43 000	1 930 000	4 400 000
660.011 25.9847	855.015 33.6620	319.990 12.5980	319.990 12.5980	5.2	5.2	6 500	18 000	665 000	1 840 000
660.400 26.0000	812.800 32.0000	365.125 14.3750	365.125 14.3750	3.3	6.4	7 350	22 800	750 000	2 330 000
670	950	700	700	7.5	7.5	18 000	49 500	1 830 000	5 050 000
	960	700	700	7.5	7.5	18 600	48 500	1 900 000	4 950 000
	980	475	475	7.5	7.5	12 600	29 200	1 280 000	2 980 000
	1 090	690	690	7.5	7.5	20 600	47 000	2 100 000	4 800 000
679.450 26.7500	901.700 35.5000	552.450 21.7500	552.450 21.7500	3.3	6.4	12 200	36 500	1 240 000	3 750 000
680	870	460	460	5	5	9 700	30 000	990 000	3 100 000
	1 000	505	505	10	10	13 000	31 500	1 330 000	3 200 000
680.000 26.7717	870.000 34.2520	460.000 18.1102	460.000 18.1102	5.0	5.0	9 700	30 000	990 000	3 100 000
682.625 26.8750	965.200 38.0000	701.675 27.6250	701.675 27.6250	3.3	6.4	17 700	50 000	1 800 000	5 100 000
685	965	700	700	7.5	7.5	17 700	50 000	1 800 000	5 100 000
685.800 27.0000	876.300 34.5000	352.425 13.8750	355.600 14.0000	3.3	6.4	7 400	22 200	755 000	2 270 000
708.025 27.8750	930.275 36.6250	565.150 22.2500	565.150 22.2500	3.3	6.4	13 200	40 500	1 350 000	4 100 000
710	900	410	410	3.3	6.4	8 100	24 400	825 000	2 490 000
	1 000	730	730	7.5	7.5	19 400	55 500	1 970 000	5 650 000
	1 030	490	490	7.5	7.5	13 200	32 500	1 350 000	3 300 000
	1 150	710	710	9.5	9.5	22 200	52 000	2 260 000	5 300 000
711.200 28.0000	914.400 36.0000	317.500 12.5000	317.500 12.5000	3.3	6.4	6 400	19 300	655 000	1 970 000
	914.400 36.0000	317.500 12.5000	317.500 12.5000	16.0	6.4	6 400	19 300	655 000	1 970 000
	914.400 36.0000	355.600 14.0000	355.600 14.0000	3.3	6.4	7 300	22 200	745 000	2 260 000

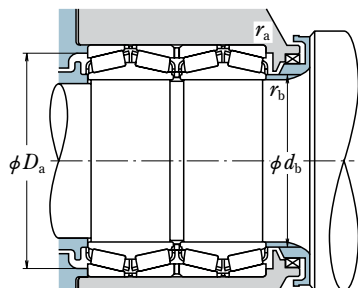

Dynamic Equivalent Load

$$P = XF_r + YF_a$$

$F_a/F_r \leq e$		$F_a/F_r > e$	
X	Y	X	Y
1	Y_3	0.67	Y_2

Static Equivalent Load

$$P_0 = F_r + Y_0 F_a$$

Where $Y_0 \doteq Y_3$

The values of e , Y_2 , and Y_3 are given in the table below.

Bearing Numbers	Figure ⁽¹⁾	Abutment and Fillet Dimensions (mm)				Constant e	Axial Load Factors		Mass (kg) approx.	Reference Bearing Numbers
		d_b	D_a	r_a max.	r_b max.		Y_2	Y_3		
660KV1001	2	728	992	6	6	0.33	3.0	2.0	2 340	—
*660KV8552	2	688	811	5.2	5.2	0.52	1.9	1.3	484	—
*660KV8151	2	680	778	6.4	3.3	0.33	3.0	2.0	416	L281149D-110-110D
670KV895	2	718	900	6	6	0.33	3.0	2.0	1 620	—
670KV9602	2	710	900	6	6	0.33	3.0	2.0	1 690	—
670KV80	2	730	920	6	6	0.37	2.7	1.8	1 240	—
670KV81	2	750	1 000	6	6	0.37	2.7	1.8	2 600	—
*679KV9051	2	710	852	6.4	3.3	0.33	3.0	2.0	1 000	LM281849DW-810-810D
680KV8701	2	707	827	4	4	0.42	2.4	1.6	695	—
680KV1001	2	737	936	10	10	0.33	3.0	2.0	1 380	—
*680KV8751	2	706	827	5.0	5.0	0.42	2.4	1.6	695	—
*682KV9651	2	734	900	6.4	3.3	0.33	3.0	2.0	1 670	M282249D-210-210D
685KV895	2	734	900	6	6	0.33	3.0	2.0	1 650	—
*685KV8751	2	714	832	6.4	3.3	0.42	2.4	1.6	543	EE655271DW-345-346D
*708KV9351	2	737	880	6.4	3.3	0.33	3.0	2.0	1 070	LM282549D-510-510D
710KV9001	2	735	853	6.4	3.3	0.53	1.9	1.3	637	L882449D-410-410D
710KV895	2	760	945	6	6	0.33	3.0	2.0	1 850	—
710KV80	2	785	965	6	6	0.37	2.7	1.8	1 390	—
710KV81	2	800	1 055	8	8	0.37	2.7	1.8	2 970	—
*711KV9151	2	747	871	6.4	3.3	0.38	2.6	1.8	549	EE755281D-360-361D
*711KV9151a	2	760	871	6.4	16.0	0.38	2.6	1.8	549	EE755280DW-360-361D
*711KV9152	2	742	869	6.4	3.3	0.44	2.3	1.5	607	—

Note * Bearings marked * are inch design.

⁽¹⁾ Refer to page **B 343**

FOUR-ROW TAPERED ROLLER BEARINGS

KV (TQO) Type

Bore Diameter 714.375 – 863.600 mm

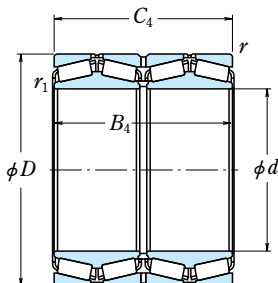

Boundary Dimensions (mm/inch)						Basic Load Ratings (kN) (kgf)			
d	D	B_4	C_4	r_1 min.	r min.	C_r	C_{0r}	C_r	C_{0r}
714.375 28.1250	1 016.000 40.0000	704.850 27.7500	704.850 27.7500	3.3	6.4	19 000	52 500	1 940 000	5 350 000
717.550 28.2500	946.150 37.2500	565.150 22.2500	565.150 22.2500	3.3	6.4	13 400	41 000	1 370 000	4 150 000
730	1 035	755	755	7.5	7.5	20 400	58 500	2 080 000	6 000 000
730.250 28.7500	1 035.050 40.7500	755.650 29.7500	755.650 29.7500	3.3	6.4	20 900	58 000	2 130 000	5 950 000
749.300 29.5000	990.600 39.0000	605.000 23.8189	605.000 23.8189	3.3	6.4	15 200	47 000	1 550 000	4 800 000
	1 066.800 42.0000	723.900 28.5000	736.600 29.0000	spec.	12.7	20 600	58 000	2 100 000	5 900 000
750	1 090 1 220	515 750	515 750	7.5 9.5	7.5 9.5	14 700 24 900	36 500 59 000	1 500 000 2 540 000	3 700 000 6 000 000
762.000 30.0000	1 066.800 42.0000	723.900 28.5000	736.600 29.0000	5.0	12.7	21 000	59 500	2 150 000	6 050 000
	1 079.500 42.5000	787.400 31.0000	787.400 31.0000	4.8	12.7	22 800	63 500	2 330 000	6 500 000
785	1 030	605	605	6	7.5	15 300	47 500	1 560 000	4 850 000
785.000 30.9055	1 040.000 40.9449	560.000 22.0472	560.000 22.0472	4.8	9.7	14 200	41 500	1 450 000	4 200 000
800.000 31.4961	1 120.000 44.0945	820.000 32.2835	820.000 32.2835	7.0	7.0	23 800	69 000	2 430 000	7 050 000
825.500 32.5000	1 168.400 46.0000	844.550 33.2500	844.550 33.2500	4.8	12.7	25 900	76 000	2 640 000	7 750 000
840.000 33.0709	1 170.000 46.0630	840.000 33.0709	840.000 33.0709	7.0	7.0	25 900	76 000	2 640 000	7 750 000
863.600 34.0000	1 130.300 44.5000	669.925 26.3750	669.925 26.3750	4.8	12.7	19 600	62 000	1 990 000	6 300 000
	1 181.100 46.5000	666.750 26.2500	666.750 26.2500	4.8	12.7	19 600	62 000	1 990 000	6 300 000
	1 219.200 48.0000	876.300 34.5000	889.000 35.0000	4.8	12.7	28 300	81 000	2 890 000	8 250 000

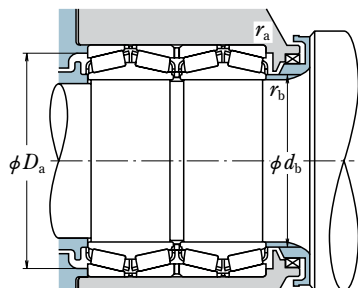

Dynamic Equivalent Load

$$P = XF_r + YF_a$$

$F_a/F_r \leq e$		$F_a/F_r > e$	
X	Y	X	Y
1	Y_3	0.67	Y_2

Static Equivalent Load

$$P_0 = F_r + Y_0 F_a$$

Where $Y_0 \doteq Y_3$

The values of e , Y_2 , and Y_3 are given in the table below.

Bearing Numbers	Figure ⁽¹⁾	Abutment and Fillet Dimensions (mm)				Constant e	Axial Load Factors		Mass (kg) approx.	Reference Bearing Numbers
		d_b	D_a	r_a max.	r_b max.		Y_2	Y_3		
*714KV1051	2	756	953	6.4	3.3	0.35	2.9	1.9	1 890	M383240D-210-210D
*717KV9451	2	753	894	6.4	3.3	0.33	3.0	2.0	1 100	LM282847DW-810-810D
730KV895	2	796	970	6	6	0.33	3.0	2.0	2 070	—
*730KV1051	2	769	971	6.4	3.3	0.33	3.0	2.0	2 090	M283449DW-410-410D
*749KV9951	2	782	938	6.4	3.3	0.33	3.0	2.0	1 310	LM283649D-610-610D
*749KV1051	2	800	994	12.7	—	0.33	3.1	2.1	2 190	EE325296D-420-421XD
750KV80	2	830	1 025	6	6	0.37	2.7	1.8	1 640	—
750KV81	2	855	1 125	8	8	0.37	2.7	1.8	3 550	—
*762KV1051	2	803	995	12.7	5.0	0.33	3.1	2.1	2 100	M284148DW-111-110D
*762KV1052	2	802	1 007	12.7	4.8	0.33	3.1	2.1	2 380	M284249DW-210-210D
785KV1002	2	817	971	6	5	0.42	2.4	1.6	1 390	—
*785KV1051	2	820	981	9.7	4.8	0.42	2.4	1.6	1 330	—
*800KV1151	2	843	1 050	7.0	7.0	0.33	3.0	2.0	2 600	—
*825KV1151	2	873	1 089	12.7	4.8	0.33	3.0	2.0	3 020	M285848DW-810-810D
*840KV1151	2	885	1 099	7.0	7.0	0.33	3.0	2.0	2 900	—
*863KV1151	2	901	1 067	12.7	4.8	0.33	3.0	2.0	1 870	LM286249DW-210-210D
*863KV1153	2	901	1 092	12.7	4.8	0.33	3.0	2.0	2 210	LM286449D-410-410D
*863KV1252	2	911	1 139	12.7	4.8	0.33	3.0	2.0	3 350	—

Note * Bearings marked * are inch design.

⁽¹⁾ Refer to page **B 343**

FOUR-ROW TAPERED ROLLER BEARINGS

KV (TQ0) Type

Bore Diameter 901.700 – 1 500 mm

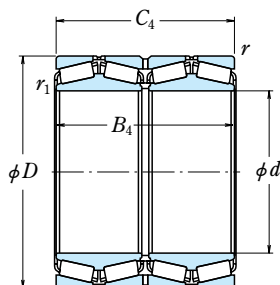

<i>d</i>	Boundary Dimensions (mm/inch)					Basic Load Ratings (kN) (kgf)			
	<i>D</i>	<i>B</i> ₄	<i>C</i> ₄	<i>r</i> ₁ min.	<i>r</i> min.	<i>C</i> _r	<i>C</i> _{0r}	<i>C</i> _r	<i>C</i> _{0r}
901.700 35.5000	1 295.400 51.0000	901.700 35.5000	914.400 36.0000	4.8	12.7	30 500	88 000	3 100 000	8 950 000
938.212 36.9375	1 270.000 50.0000	825.500 32.5000	825.500 32.5000	4.8	12.7	26 100	79 500	2 660 000	8 100 000
939.800 37.0000	1 333.500 52.5000	952.500 37.5000	952.500 37.5000	4.8	12.7	31 500	92 000	3 200 000	9 400 000
1 006.475 39.6250	1 295.400 51.0000	764.000 30.0787	764.000 30.0787	4.8	12.7	23 100	76 500	2 360 000	7 800 000
1 200.150 47.2500	1 593.850 62.7500	990.600 39.0000	990.600 39.0000	4.8	12.7	39 500	128 000	4 000 000	13 100 000
1 500	1 915	1 220	1 105	spec.	spec.	44 500	168 000	4 550 000	17 100 000

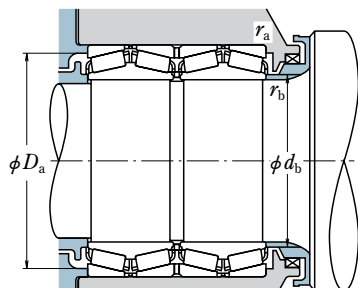

Dynamic Equivalent Load

$$P = XF_r + YF_a$$

$F_a/F_r \leq e$		$F_a/F_r > e$	
X	Y	X	Y
1	Y_3	0.67	Y_2

Static Equivalent Load

$$P_0 = F_r + Y_0 F_a$$

Where $Y_0 \doteq Y_3$

The values of e , Y_2 , and Y_3 are given in the table below.

Bearing Numbers	Figure ⁽¹⁾	Abutment and Fillet Dimensions (mm)				Constant	Axial Load Factors		Mass (kg) approx.	Reference Bearing Numbers
		d_b	D_a	r_a max.	r_b max.		e	Y_2		
*901KV1251	2	960	1 205	12.7	4.8	0.33	3.0	2.0	4 010	EE634356D-510-510D
*938KV1251	2	990	1 190	12.7	4.8	0.33	3.0	2.0	3 090	LM287649D-610-610D
*939KV1351	2	996	1 246	12.7	4.8	0.33	3.0	2.0	4 380	LM287849DW-810-810D
*1006KV1251	2	1 055	1 225	12.7	4.8	0.33	3.0	2.0	2 590	LM288249D-210-210D
*1200KV1551	2	1 249	1 506	12.7	4.8	0.33	3.0	2.0	5 560	LM288949D-910-910D
1500KV1901	2	1 580	1 815	13	6	0.33	3.0	2.0	8 410	—

Note * Bearings marked * are inch design.

(1) Refer to page **B 343**

SEALED-CLEAN FOUR-ROW TAPERED ROLLER BEARINGS

KVE (TQO) Type

Bore Diameter 101.600 – 276.225 mm

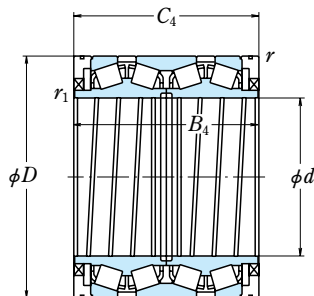

KVE

Boundary Dimensions (mm/inch)						Basic Load Ratings (kN) (kgf)			
<i>d</i>	<i>D</i>	<i>B</i> ₄	<i>C</i> ₄	<i>r</i> ₁ min.	<i>r</i> min.	<i>C</i> _r	<i>C</i> _{0r}	<i>C</i> _r	<i>C</i> _{0r}
101.600 4.0000	200.025 7.8750	320.000 12.5984	320.000 12.5984	1.0	3.0	1 450	2 420	148 000	247 000
150	210	240	240	1	2.5	990	2 270	101 000	231 000
170	240	175	175	2.5	2.5	1 010	2 000	103 000	204 000
187.325 7.3750	269.875 10.6250	230.000 9.0551	230.000 9.0551	2.0	3.3	1 460	3 200	149 000	325 000
215.900 8.5000	288.925 11.3750	177.800 7.0000	177.800 7.0000	0.8	3.3	1 070	2 350	109 000	239 000
216.103 8.5080	330.2 13.0000	263.525 10.3750	269.875 10.6250	1.5	3.3	2 290	4 550	233 000	465 000
220	295 295 300	315 335 270	315 335 270	1 1 2.5	2.5 2.5 2.5	1 410 1 410 1 650	3 450 3 450 4 000	144 000 144 000 168 000	350 000 350 000 410 000
225	320	290	290	1.5	2.5	1 970	4 500	201 000	460 000
228.600 9.0000	400.050 15.7500	296.875 11.6880	296.875 11.6880	3.3	3.3	2 330 2 410	4 800 4 250	237 000 246 000	490 000 435 000
234.950 9.2500	327.025 12.8750	196.850 7.7500	196.850 7.7500	1.5	3.3	1 550	3 200	158 000	325 000
240	320 338 338	250 248 290	250 248 290	3 2 2	3 3 3	1 510 1 820 2 120	3 700 4 000 5 000	154 000 185 000 216 000	375 000 405 000 510 000
244.475 9.6250	327.025 12.8750	193.680 7.6250	193.680 7.6250	1.5	3	1 450	3 300	148 000	325 000
245	345	310	310	2	3	2 700	6 650	275 000	680 000
250	365 365	270 270	270 270	2.5 2.5	3 3	2 210 2 210	4 650 4 650	225 000 225 000	475 000 475 000
254.000 10.0000	358.775 14.1250	269.875 10.6250	269.875 10.6250	1.5	3.3	2 420	5 500	247 000	560 000
260	365 365	340 340	340 340	2.7 2.5	4 4	2 960 2 960	7 350 7 350	300 000 300 000	750 000 750 000
260.350 10.2500	422.275 16.6250	314.325 12.3750	317.500 12.5000	6.4	3.3	3 600	7 050	370 000	720 000
266.700 10.5000	355.600 14.0000	230.188 9.0625	228.600 9.0000	1.5	3.3	1 960	4 600	200 000	470 000
276.225 10.8750	393.700 15.5000	269.875 10.6251	269.875 10.6251	1.5	3.3	2 720	6 100	277 000	620 000

Dynamic Equivalent Load

$$P = XF_r + YF_a$$

$F_a/F_r \leq e$		$F_a/F_r > e$	
X	Y	X	Y
1	Y_3	0.67	Y_2

Static Equivalent Load

$$P_0 = F_r + Y_0 F_a$$

Where $Y_0 \doteq Y_3$

The values of e , Y_2 , and Y_3 are given in the table below.

Bearing Numbers	Figure ⁽¹⁾	Constant	Axial Load Factors		Mass (kg)
		e	Y_2	Y_3	approx.
*101KVE2051	3-2	0.36	2.8	1.9	47.8
150KVE2101E	3-1	0.32	3.2	2.1	26.1
STF170KVS2401Eg	5	0.32	3.2	2.1	23
*187KVE2651E	3-1	0.29	3.4	2.3	43.6
*STF215KVS2851Eg	5	0.49	2.1	1.4	38
*STF216KVS3351Eg	5	0.46	2.2	1.5	77
220KVE2902	4-1	0.40	2.5	1.7	61.2
220KVE2901	4-1	0.40	2.5	1.7	65
220KVE3001E	3-2	0.41	2.5	1.7	56.5
220KVE3201E	3	0.33	3.0	2.0	78.7
STF220KVS3301Eg	5	0.40	2.5	1.7	76
225KVE3201E	3	0.41	2.4	1.6	59.9
*228KVE4052E	3	0.46	2.2	1.5	161
*STF234KVS3251Eg	5	0.46	2.2	1.5	49
240KVE3202E	3	0.33	3.0	2.0	56.3
240KVE3301E	3	0.43	2.3	1.6	70.6
240KVE3302E	3	0.42	2.4	1.6	82.6
*STF244KVS3251Eg	5	0.40	2.5	1.7	43
STF245KVS3402Eg	5	0.40	2.5	1.7	85
250KVE3601AE	3	0.33	3.0	2.0	96
250KVE3601E	3-1	0.33	3.0	2.0	96
STF254KVS3552Eg	5	0.40	2.5	1.7	86
STF260KVS3601Eg	5	0.40	2.5	1.7	110
STF260KVS3651Eg	5	0.40	2.5	1.7	110
*STF260KVS4251Eg	5	0.33	3.0	2.0	170
*STF266KVS3551Eg	5	0.35	2.9	1.9	62
*STF276KVS3952Eg	5	0.45	2.2	1.5	105

Note * Bearings marked * are inch design.

⁽¹⁾ Refer to page **B 343**

SEALED-CLEAN FOUR-ROW TAPERED ROLLER BEARINGS

KVE (TQO) Type

Bore Diameter 279.400 – 420 mm

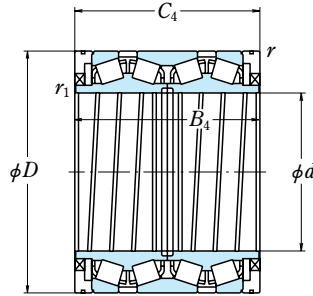

KVE

Boundary Dimensions (mm/inch)						Basic Load Ratings (kN) (kgf)			
<i>d</i>	<i>D</i>	<i>B</i> ₄	<i>C</i> ₄	<i>r</i> ₁ min.	<i>r</i> min.	<i>C</i> _r	<i>C</i> _{0r}	<i>C</i> _r	<i>C</i> _{0r}
279.400 11.0000	393.700 15.5000	269.875 10.6250	269.875 10.6250	1.5	6.4	2 720	6 100	277 000	620 000
	393.700 15.5000	270.630 10.6547	269.875 10.6250	1.5	6.4	2 290	5 150	233 000	525 000
279.4	393.7 410	320 420	320 420	1.5 1	6.4 6.4	3 100 3 300	7 350 7 400	315 000 335 000	745 000 755 000
280	380 395 395	290 340 340	290 340 340	1.5 1.5 1.5	3 2.5 2.5	2 230 2 950 2 950	5 350 7 050 7 050	227 000 300 000 300 000	545 000 720 000 720 000
	410 412	268 340	268 340	1.5 3	6.4 3	2 330 3 300	4 600 7 400	237 000 335 000	470 000 755 000
290	400	346	346	3	4	3 250	8 400	330 000	855 000
304.648 11.9940	438.048 17.2460	280.990 11.6260	279.400 11.0000	3.3	3.3	3 100	6 750	315 000	690 000
304.648 11.9940	438.048 17.2460	281.740 11.0921	279.400 11.0000	3.3	3.3	2 630	5 600	268 000	570 000
304.8 12.0000	419.100 16.5000	269.875 10.6250	269.875 10.6250	1.5	6.4	2 850	6 550	291 000	665 000
304.902 12.0040	412.648 16.2460	266.700 10.5000	266.700 10.5000	1.5	3.3	2 760	6 500	281 000	665 000
310	430 430	310 350	310 350	3 2.7	3 3	3 350 3 700	8 200 9 550	345 000 375 000	835 000 970 000
317.500 12.5000	422.275 16.6250	269.875 10.6250	269.875 10.6250	1.5	3.3	2 740	6 750	279 000	690 000
317.500 12.5000	447.675 17.6250	367.000 14.4488	367.000 14.4488	2.5	3.0	3 450	8 100	350 000	825 000
343.052 13.5060	457.098 17.9960	254.000 10.0000	254.000 10.0000	1.5	3.3	2 830	6 700	289 000	685 000
	457.098 17.9960	299.000 11.7717	299.000 11.7717	1.5	3.3	2 830	6 950	289 000	705 000
355.600 14.0000	457.200 18.0000	252.412 9.9375	252.412 9.9375	1.5	3.3	2 650	6 750	270 000	685 000
395	545	360	360	2.5	5	3 650	9 250	375 000	945 000
406.400 16.0000	546.100 21.5000	288.925 11.3750	288.925 11.3750	1.5	6.4	3 950	9 450	400 000	965 000
	546.100 21.5000	346.000 13.6221	346.000 13.6221	0.5	6.4	2 560	5 800	261 000	590 000
420	590	395	375	2.5	5	3 550	8 200	365 000	835 000

Dynamic Equivalent Load

$$P = XF_r + YF_a$$

$F_a/F_r \leq e$		$F_a/F_r > e$	
X	Y	X	Y
1	Y_3	0.67	Y_2

Static Equivalent Load

$$P_0 = F_r + Y_0 F_a$$

Where $Y_0 \doteq Y_3$

The values of e , Y_2 , and Y_3 are given in the table below.

Bearing Numbers	Figure ⁽¹⁾	Constant e	Axial Load Factors		Mass (kg) approx.
			Y_2	Y_3	
*STF279KVS3952Eg	5	0.45	2.2	1.5	102
*279KVE3951E	3	0.41	2.5	1.7	105
STF279KVS3954Eg	5	0.40	2.5	1.7	120
279KVE4101	4	0.42	2.4	1.6	190
280KVE3801E	3	0.37	2.7	1.8	96.2
280KVE3901E	3-4	0.40	2.5	1.7	133
280KVE3902E	3	0.40	2.5	1.7	133
280KVE4101E	3-4	0.33	3.0	2.0	121
280KVE4102E	3-1	0.42	2.4	1.6	156
STF290KVS4001Eg	5	0.40	2.5	1.7	112
*STF304KVS4351Eg	5	0.45	2.2	1.5	132
*304KVE4351E	3-2	0.47	2.1	1.4	140
*STF304KVS4151Eg	5	0.33	3.0	2.0	111
*STF304KVS4152Eg	5	0.33	3.0	2.0	100
STF310KVS4301Eg	5	0.46	2.2	1.5	140
STF310KVS4302Eg	5	0.46	2.2	1.5	155
*STF317KVS4251Eg	5	0.34	3.0	2.0	100
*317KVE4451E	3	0.46	2.2	1.5	184
*STF343KVS4551Eg	5	0.45	2.2	1.5	110
*343KVE4561E	3	0.46	2.2	1.5	137
*STF355KVS4551Eg	5	0.32	3.2	2.1	98
395KVE5401E	3-1	0.47	2.1	1.4	255
*STF406KVS5451Eg	5	0.48	2.1	1.4	184
*406KVE5454E	4-1	0.47	2.1	1.4	231
420KVE5901E	3-1	0.80	1.3	0.8	332

Note * Bearings marked * are inch design.

⁽¹⁾ Refer to page **B 343**

SEALED-CLEAN FOUR-ROW TAPERED ROLLER BEARINGS

KVE (TQO) Type

Bore Diameter 440 – 825.5 mm

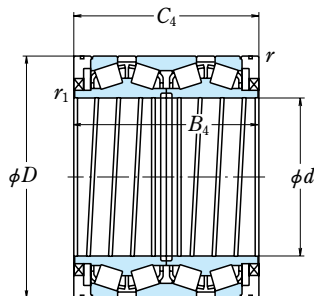

KVE

Boundary Dimensions (mm/inch)					Basic Load Ratings (kN) (kgf)				
d	D	B_4	C_4	r_1 min.	r min.	C_r	C_{0r}	C_r	C_{0r}
440	590	510	510	4	4	5 450	14 300	555 000	1 460 000
	620	454	454	4	6	6 500	15 700	665 000	1 600 000
450	595	368	368	4	5	5 550	15 000	565 000	1 520 000
457.200	596.900	276.220	279.400	1.5	3.3	4 000	9 850	405 000	1 010 000
18.0000	23.5000	10.8748	11.0000						
460	590	470	470	2.5	5	4 900	14 100	500 000	1 440 000
480	615	435	435	3	5	4 650	12 800	470 000	1 310 000
	678	574	574	3	5	8 400	21 500	860 000	2 190 000
482.600	615.950	330.200	330.200	4.3	6.4	4 900	13 500	500 000	1 370 000
19.0000	24.2500	13.0000	13.0000						
482.600	615.950	330.200	330.200	4.3	6.4	3 650	9 650	370 000	985 000
19.0000	24.2500	13.0000	13.0000						
	615.950	419.100	402.050	2.3	6.4	4 700	13 600	480 000	1 380 000
	24.2500	16.5000	15.8287						
	647.700	417.512	417.512	3.3	6.4	5 500	13 800	560 000	1 410 000
	25.5000	16.4375	16.4375						
488.950	622.300	365.125	365.125	3.8	6.4	3 450	8 950	350 000	915 000
19.2500	24.5000	14.3750	14.3750						
490	625	435	435	3	5	4 550	12 500	465 000	1 280 000
509.948	654.924	377.000	379.000	1.5	6.4	4 800	13 000	490 000	1 330 000
20.0767	25.7844	14.8425	14.9213						
520	735	535	535	5	6	8 800	22 700	900 000	2 310 000
558.800	736.600	540.000	540.000	3.3	6.4	8 950	25 300	910 000	2 580 000
22.0000	29.0000	21.2598	21.2598						
595.312	844.550	615.950	615.950	1.5	6.4	12 600	33 000	1 290 000	3 350 000
23.4375	33.2500	24.2500	24.2500						
	844.550	615.950	615.950	3.3	6.4	10 900	27 200	1 110 000	2 780 000
	33.2500	24.2500	24.2500						
609.600	787.400	361.950	361.950	1.5	6.4	5 450	14 400	555 000	1 470 000
24.0000	31.0000	14.2500	14.2500						
711.200	914.400	387.350	317.500	3.3	6.4	6 400	19 300	655 000	1 970 000
28.0000	36.0000	15.2500	12.5000						
	914.400	410.000	410.000	3.3	6.4	7 000	20 100	715 000	2 050 000
	36.0000	16.1417	16.1417						
	914.400	425.450	387.350	8.0	6.4	6 400	19 300	655 000	1 970 000
	36.0000	16.7500	15.2500						
785	1 015	700	700	4	6	13 500	41 000	1 380 000	4 150 000
825.5	1 160	565	565	5	6	13 900	33 500	1 420 000	3 400 000

Dynamic Equivalent Load

$$P = XF_r + YF_a$$

$F_a/F_r \leq e$		$F_a/F_r > e$	
X	Y	X	Y
1	Y_3	0.67	Y_2

Static Equivalent Load

$$P_0 = F_r + Y_0 F_a$$

Where $Y_0 \doteq Y_3$

The values of e , Y_2 , and Y_3 are given in the table below.

Bearing Numbers	Fig- ure ⁽¹⁾	Constant	Axial Load Factors		Mass (kg) approx.
		e	Y_2	Y_3	
440KVE5901E	4-1	0.38	2.7	1.8	396
440KVE6201E	3-1	0.33	3.0	2.0	435
STF450KVS5901Eg	5	0.33	3.0	2.0	272
*STF457KVS5951Eg	5	0.47	2.2	1.4	206
460KVE5901E	3-1	0.28	3.6	2.4	322
480KVE6101A	4-2	0.32	3.2	2.1	323
480KVE6702E	4-1	0.34	3.0	2.0	662
*STF482KVS6151Eg	5	0.33	3.1	2.1	235
*482KVE6152E	3	0.37	2.7	1.8	243
*482KVE6155E	3	0.38	2.7	1.8	302
*482KVE6453E	3-5	0.37	2.7	1.8	392
*488KVE6251E	4	0.29	3.5	2.3	272
490KVE6201A	4-2	0.32	3.2	2.1	329
*509KVE6554E	3	0.41	2.4	1.6	321
520KVE7301E	3-1	0.33	3.0	2.0	726
*558KVE7351E	3-3	0.35	2.9	1.9	625
*595KVE8451E	3	0.33	3.0	2.0	1 110
*595KVE8452E	4	0.35	2.9	1.9	1 110
*609KVE7851E	3	0.42	2.4	1.6	452
*711KVE9152A	3	0.38	2.6	1.8	585
*711KVE9153E	3-1	0.44	2.3	1.5	681
*711KVE9155E	3	0.38	2.6	1.8	675
785KVE1001E	4-1	0.40	2.5	1.7	1 460
825KVE1101E	3	0.40	2.5	1.7	1 890

Note * Bearings marked * are inch design.

⁽¹⁾ Refer to page **B 343**

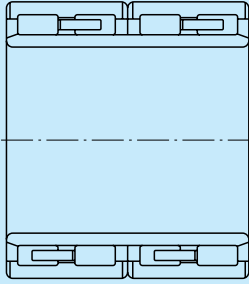
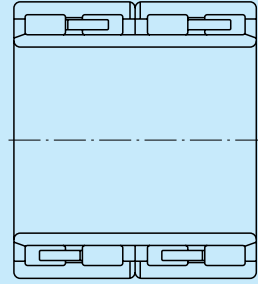
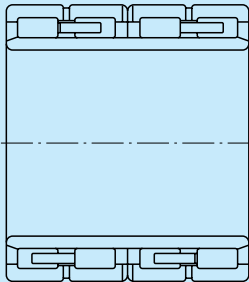
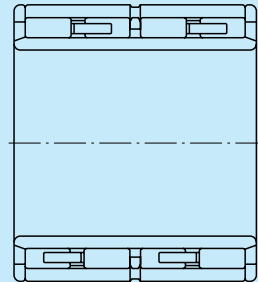
Figures of Typical Four-Row Cylindrical Roller Bearings**Cylindrical Bores****Figure 1****Figure 2****Figure 3****Figure 4**

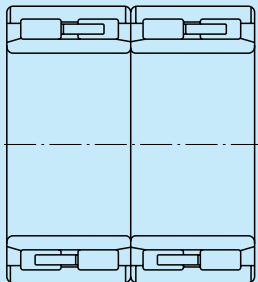

Figure 5

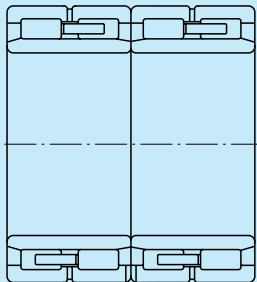

Figure 6

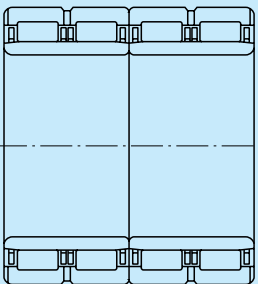

Figure 7

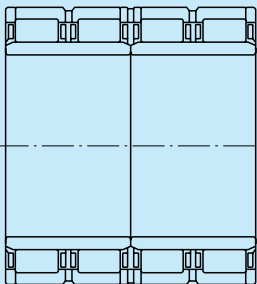

Figure 8

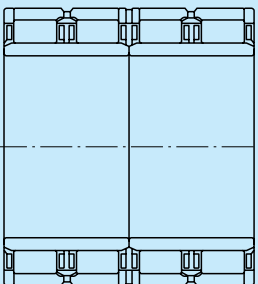
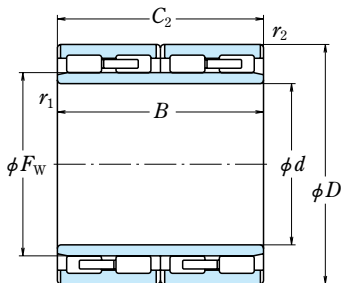

Figure 9

FOUR-ROW CYLINDRICAL ROLLER BEARINGS

RV Type

Bore Diameter 100 – 170 mm



<i>d</i>	Boundary Dimensions (mm)						Basic Load Ratings			
	<i>D</i>	<i>B</i>	<i>C</i> ₂	<i>F</i> _w	<i>r</i> ₁ min.	<i>r</i> ₂ min.	<i>C</i> _r (kN)	<i>C</i> _{0r} (kN)	<i>C</i> _r (kgf)	<i>C</i> _{0r} (kgf)
100	140	104	104	111	1.5	1.1	400	820	41 000	84 000
110	170	120	120	127	2	2	615	1 100	62 500	112 000
120	165	87	87	134.5	1.1	1.1	365	725	37 500	74 000
	180	105	105	136	2	2	530	880	54 000	89 500
	215	174	174	147	2.1	2.1	1 060	1 600	108 000	164 000
127	174.625	150.812	150.812	139.5	1.5	1.5	735	1 580	75 000	161 000
	203.2	127	127	147.5	2	2	705	1 110	72 000	113 000
130	200	125	125	149	2	2	700	1 190	71 000	121 000
	200	104	104	149	2	2	570	950	58 000	97 000
140	210	116	116	160	2	2	640	1 130	65 500	116 000
145	210	155	155	166	1.5	1.5	925	1 920	94 000	196 000
	225	156	156	169	2	2	975	1 820	99 000	185 000
150	220	150	150	168	2	2	900	1 700	91 500	174 000
	225	150	150	168.5	1.5	2.1	970	1 810	99 000	184 000
	225	136	136	168.776	2.1	2.1	820	1 460	84 000	149 000
	230	130	130	174	2.1	2.1	845	1 520	86 000	155 000
	230	156	156	174	2	2	965	1 810	98 500	185 000
159.99	220	180	180	176	2	2	1 050	2 410	107 000	245 000
160	230	130	130	178	2	2	780	1 340	79 500	136 000
	230	168	168	180	2	2	1 040	2 200	107 000	225 000
	230	180	180	178	2	2	1 080	2 280	110 000	232 000
	240	120	120	183	2.1	2.1	745	1 320	76 000	135 000
	240	170	170	183	2	2	1 080	2 050	110 000	209 000
	240	145	145	180.016	2.1	2.1	920	1 600	93 500	163 000
170	230	120	120	187	2	2	755	1 610	77 000	164 000
	240	160	160	190	2	2	1 000	2 130	102 000	217 000
	250	168	168	192	2.1	2.1	1 210	2 320	123 000	237 000
	250	170	170	192	2.1	2.1	1 210	2 320	123 000	237 000
	255	180	180	193	2.1	2.1	1 310	2 500	134 000	255 000
	260	150	150	195	2.1	2.1	1 030	1 840	105 000	187 000

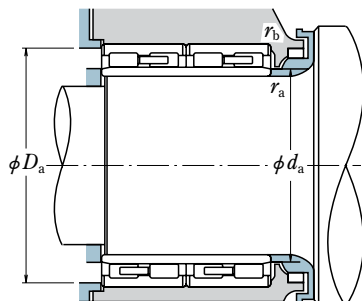

Bearing Numbers	Fig- ure ⁽¹⁾	Abutment and Fillet Dimensions (mm)				Mass (kg) approx.
		d_a	D_a	r_a max.	r_b max.	
100RV1401	3	110	130	1.5	1	4.8
110RV1701	1	122	157	2	2	9.9
120RV1601	1	130	155	1	1	5.4
120RV1801	1	132	167	2	2	8.9
120RV2101	1	134	199	2	2	26.6
127RV1722	1	138	163	1.5	1.5	10.5
127RV2001	1	139	190	2	2	15.4
130RV2001	1	142	187	2	2	14
130RV2003	1	142	187	2	2	11.7
140RV2101	1	152	196	2	2	13.9
145RV2101	1	157	197	1.5	1.5	17.8
145RV2201	1	158	211	2	2	23
150RV2201	1	163	206	2	2	20
150RV2203	1	162	209	1.5	2	20.8
150RV2204	1	165	209	2	2	18.6
150RV2301	1	165	214	2	2	19.6
150RV2302	1	163	216	2	2	23.6
159RV2201	2	173	206	2	2	20.6
160RV2301	1	173	216	2	2	16.4
160RV2302	1	173	216	2	2	22.7
160RV2303	2	173	216	2	2	24.2
160RV2401	1	175	224	2	2	18.8
160RV2402	1	173	226	2	2	26.6
160RV2403	1	175	224	2	2	22.3
170RV2301	1	183	216	2	2	14
170RV2402	1	183	226	2	2	22.8
170RV2501	1	185	234	2	2	27.4
170RV2502	1	185	234	2	2	27.7
170RV2503	1	185	239	2	2	31.5
170RV2602	1	185	244	2	2	28.2

Note (1) Refer to page **B 386**

FOUR-ROW CYLINDRICAL ROLLER BEARINGS

RV Type

Bore Diameter 180 – 240 mm

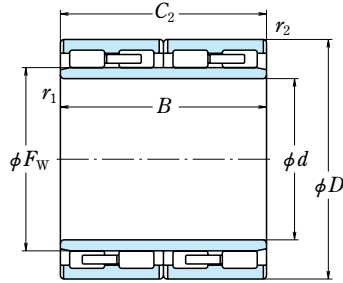

<i>d</i>	Boundary Dimensions (mm)						Basic Load Ratings			
	<i>D</i>	<i>B</i>	<i>C</i> ₂	<i>F</i> _w	<i>r</i> ₁ min.	<i>r</i> ₂ min.	(kN)	<i>C</i> _{0r}	<i>C</i> _r	<i>C</i> _{0r} (kgf)
180	250	156	156	200	2	2	1 020	2 230	104 000	227 000
	260	168	168	202	2.1	2.1	1 150	2 300	118 000	235 000
	265	180	180	204	2.1	2.1	1 340	2 690	136 000	275 000
190	265	180	180	203	2.1	2.1	1 230	2 420	126 000	247 000
	280	180	180	205.085	2.1	2.1	1 410	2 490	144 000	254 000
	260	168	168	212	2	2	1 140	2 600	116 000	265 000
200	270	200	200	212	2.1	2.1	1 470	3 100	150 000	315 000
	270	170	170	213	2.1	2.1	1 290	2 610	132 000	266 000
	270	170	170	212	2	2	1 290	2 610	132 000	266 000
210	280	200	200	214	2.1	2.1	1 480	2 920	151 000	298 000
	280	200	200	215	1	1	900	2 500	92 000	255 000
	280	200	200	224	2.1	2.1	1 410	3 200	144 000	325 000
219.954	280	200	200	222	2.1	2.1	1 410	3 200	144 000	325 000
	280	190	190	223	2.1	2.1	1 350	3 050	138 000	310 000
	280	170	170	223	2.1	2.1	1 150	2 460	117 000	251 000
220	290	192	192	226	2.1	2.1	1 420	3 000	145 000	305 000
	310	230	230	229	2.1	2.1	1 840	3 500	188 000	360 000
	320	216	216	231	3	3	2 120	3 900	216 000	400 000
222.25	290	192	192	236	2.1	2.1	1 400	3 350	142 000	340 000
	310	183	183	244.5	1.5	1	1 480	3 150	151 000	320 000
	310	192	192	247	2.1	2.1	1 540	3 450	157 000	350 000
230	310	225	225	245	2.1	2.1	1 740	3 900	178 000	395 000
	320	210	210	248	2.1	2.1	1 790	3 650	182 000	375 000
	320	210	210	246	2.1	2.1	1 900	3 750	194 000	380 000
240	320.675	241.3	241.3	251	2.1	2.1	1 990	4 350	203 000	445 000
	330	206	206	260	2.1	2.1	1 760	3 900	180 000	395 000
	340	260	260	261	3	3	2 390	5 100	244 000	520 000
240	365	250	250	266	3	3	2 310	4 300	236 000	435 000
	330	220	220	270	3	3	1 770	4 400	180 000	445 000
	340	220	220	268	3	3	1 890	3 900	193 000	400 000
	360	220	220	272	3	3	2 250	4 350	230 000	445 000

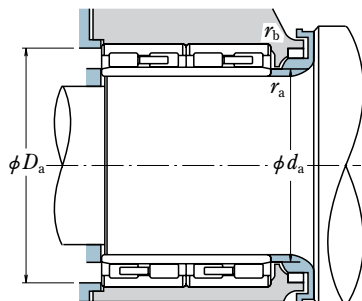

Bearing Numbers	Figure ⁽¹⁾	Abutment and Fillet Dimensions (mm)				Mass (kg) approx.
		d_a	D_a	r_a max.	r_b max.	
180RV2501	1	193	236	2	2	23.4
180RV2601	1	195	244	2	2	29.2
180RV2602	1	195	248	2	2	33.7
180RV2603	1	195	248	2	2	33.4
180RV2802	3	195	263	2	2	40.9
190RV2601	1	203	245	2	2	26.6
190RV2701	1	206	253	2	2	36
190RV2702	1	206	253	2	2	30.4
190RV2703	1	203	255	2	2	30.6
190RV2801	1	206	263	2	2	41.3
200RV2521	SP	210	240	1	1	22.3
200RV2801	1	216	263	2	2	38.3
200RV2802	1	216	263	2	2	38.6
200RV2803	1	216	263	2	2	36.4
200RV2804	1	216	263	2	2	32.3
200RV2901	1	216	273	2	2	42.3
200RV3102	1	216	293	2	2	63.7
200RV3231	4	218	300	2.5	2.5	69.9
210RV2901	1	226	273	2	2	39
219RV3131	4	233	298	1.5	1	45.3
220RV3101	1	236	293	2	2	46.1
220RV3102	1	236	293	2	2	52.9
220RV3201	1	236	302	2	2	56
220RV3203	SP	236	302	2	2	57
222RV3201	2	238	303	2	2	65
230RV3301	1	246	312	2	2	58.2
230RV3401	1	248	320	2.5	2.5	81
230RV3601	5	248	344	2.5	2.5	98.3
240RV3301	1	259	310	2.5	2.5	57.7
240RV3403	1	259	320	2.5	2.5	61.7
240RV3601	2	259	340	2.5	2.5	77.8

Note (1) Refer to pages **B 386** and **B 387**
 The letters "SP" indicate a special design. Please consult NSK for details.

FOUR-ROW CYLINDRICAL ROLLER BEARINGS

RV Type

Bore Diameter 250 – 360 mm

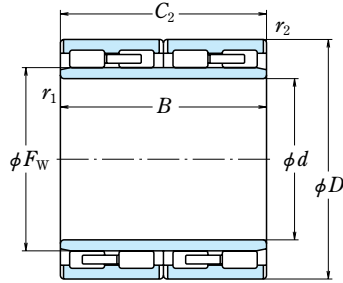

<i>d</i>	<i>D</i>	Boundary Dimensions (mm)					Basic Load Ratings			
		<i>B</i>	<i>C</i> ₂	<i>F</i> _w	<i>r</i> ₁ min.	<i>r</i> ₂ min.	(kN)	(kgf)		
							<i>C</i> _r	<i>C</i> _{0r}	<i>C</i> _r	<i>C</i> _{0r}
250	350	220	220	278	3	3	1 930	4 200	197 000	430 000
259.948	368	218	218	290	2.1	1.1	2 010	4 350	205 000	445 000
260	355	260	260	286	2.1	2.1	2 090	5 000	213 000	510 000
	370	220	220	292	3	3	2 050	4 450	209 000	455 000
	380	280	280	294	3	3	2 820	6 250	288 000	635 000
	400	290	290	296	4	4	3 250	6 350	335 000	650 000
270	380	230	230	298	2.1	2.1	2 330	5 050	238 000	515 000
280	390	220	220	312	3	3	2 120	4 800	217 000	490 000
	390	240	240	312	3	3	2 360	5 500	241 000	560 000
	390	275	275	308	3	1.1	2 860	6 450	291 000	660 000
	400	285	285	316	3	3	3 000	6 950	305 000	710 000
290	390	234	234	320	3	3	2 270	5 600	232 000	570 000
	410	240	240	320	3	3	2 570	5 450	263 000	555 000
	420	300	300	327	3	3	3 300	7 500	335 000	765 000
300	400	300	300	328	2	2	2 720	8 900	278 000	700 000
	420	240	240	332	3	3	2 670	5 750	272 000	585 000
	420	300	300	332	2	2	3 200	7 200	325 000	735 000
310	420	300	300	338	3	3	3 300	8 050	340 000	820 000
	430	240	240	344.5	3	3	2 610	5 950	266 000	605 000
320	450	240	240	358	3	3	2 760	6 150	282 000	630 000
	480	350	350	364	4	1.5	4 850	10 500	495 000	1 070 000
330	430	230	230	358	3	3	2 340	5 850	238 000	595 000
	440	200	200	360	3	3	2 160	4 750	220 000	485 000
	460	340	340	365	4	4	3 550	8 650	365 000	880 000
340	450	250	250	371	3	3	2 720	6 750	277 000	690 000
	450	250	250	368	3	3	2 720	6 750	277 000	690 000
	480	350	350	378	4	4	4 050	9 400	410 000	955 000
	480	350	350	378	spec.	1.5	4 600	11 100	470 000	1 130 000
345	480	350	350	376	3	3	4 400	10 300	450 000	1 050 000
360	480	290	290	394	3	3	3 250	8 300	335 000	850 000
	510	370	370	400	4	4	4 500	10 100	455 000	1 030 000

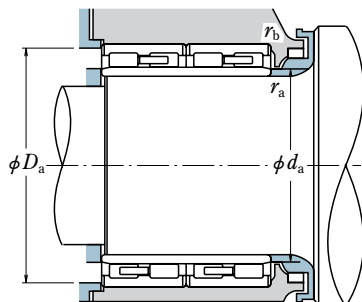

Bearing Numbers	Figure ⁽¹⁾	Abutment and Fillet Dimensions (mm)				Mass (kg) approx.
		d_a	D_a	r_a max.	r_b max.	
250RV3501	1	269	330	2.5	2.5	64.8
259RV3631	4	277	354	2	1	76.7
260RV3521	5	277	337	2	2	74.5
260RV3701	1	279	349	2.5	2.5	76
260RV3801	1	279	359	2.5	2.5	107
260RV4001	1	282	376	3	3	133
270RV3801	1	287	361	2	2	83
280RV3901	1	299	369	2.5	2.5	80.9
280RV3902	1	299	369	2.5	2.5	88.5
280RV3903	1	299	375	2.5	1	100
280RV4021	5	299	379	2.5	2.5	117
290RV3901	1	310	369	2.5	2.5	79.7
290RV4101	1	310	389	2.5	2.5	99
290RV4201	1	310	398	2.5	2.5	138
300RV4021	5	316	383	2	2	103
300RV4201	1	320	398	2.5	2.5	101
300RV4221	5	316	402	2	2	128
310RV4201	1	330	398	2.5	2.5	119
310RV4301	1	330	408	2.5	2.5	107
320RV4501	1	340	428	2.5	2.5	120
320RV4811	8	343	462	3	1.5	232
330RV4301	1	350	408	2.5	2.5	86.3
330RV4401	3	350	418	2.5	2.5	83.8
330RV4601	1	353	435	3	3	174
340RV4501	1	361	428	2.5	2.5	108
340RV4502	3	361	428	2.5	2.5	108
340RV4801	1	364	454	3	3	198
340RV4812E	1	355	462	2.9	1.5	208
345RV4821	6	366	457	2.5	2.5	190
360RV4801	1	381	457	2.5	2.5	146
360RV5101	1	384	484	3	3	234

Note ⁽¹⁾ Refer to pages **B 386** and **B 387**

FOUR-ROW CYLINDRICAL ROLLER BEARINGS

RV Type

Bore Diameter 370 – 460 mm

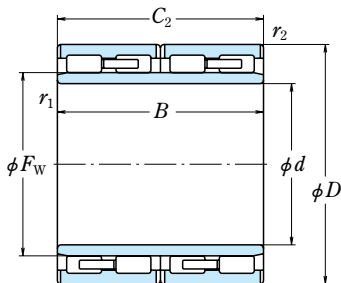

<i>d</i>	Boundary Dimensions (mm)						Basic Load Ratings			
	<i>D</i>	<i>B</i>	<i>C</i> ₂	<i>F</i> _w	<i>r</i> ₁ min.	<i>r</i> ₂ min.	<i>C</i> _r (kN)	<i>C</i> _{0r} (kN)	<i>C</i> _r (kgf)	<i>C</i> _{0r} (kgf)
370	480	250	250	401	3	3	2 830	7 350	289 000	745 000
	520	380	380	409	4	2	6 000	14 400	615 000	1 460 000
	540	400	400	415	4	4	5 250	12 000	535 000	1 230 000
380	500	290	290	414	3	3	3 350	8 800	345 000	895 000
	520	290	290	418	4	4	3 750	8 850	385 000	900 000
	520	280	280	417	4	4	3 650	8 450	370 000	865 000
	540	340	340	424	5	5	4 700	10 900	475 000	1 110 000
	540	400	400	424	5	5	5 050	12 000	515 000	1 220 000
	540	400	400	422	5	2	6 000	14 400	610 000	1 470 000
	540	400	380	424	5	2	5 750	13 800	590 000	1 410 000
390	510	290	290	424	3	3	3 400	9 000	350 000	920 000
	550	400	400	434	5	5	5 150	12 400	525 000	1 260 000
400	520	250	250	432	4	4	3 000	7 700	305 000	785 000
	550	300	300	441	4	4	4 150	9 750	420 000	995 000
	560	400	400	446	5	5	5 650	13 600	575 000	1 390 000
	560	410	410	445	5	2	6 550	16 500	670 000	1 680 000
	560	400	400	446	5	5	4 750	11 300	485 000	1 150 000
560	410	410	445	5	2	6 550	16 500	670 000	1 680 000	
406.4	609.6	304.8	304.8	460	5	5	4 650	9 150	475 000	930 000
410	600	440	440	460	5	5	7 350	16 600	750 000	1 690 000
420	560	280	280	457	4	4	3 800	9 250	390 000	945 000
	560	400	400	458	4	4	4 950	13 000	505 000	7 330 000
	600	440	440	470	5	2	7 100	17 200	725 000	1 750 000
430	591	420	420	476	4	4	5 200	13 400	530 000	1 370 000
440	620	450	450	487	5	5	7 350	17 800	750 000	1 820 000
	620	450	450	490	4	4	7 450	19 000	760 000	1 940 000
450	630	450	450	500	4	4	6 950	17 500	710 000	1 780 000
460	620	400	400	506	4	4	5 500	14 700	560 000	1 500 000
	620	400	400	502	4	4	6 400	16 600	650 000	1 690 000
	620	460	460	502	4	4	7 100	19 100	725 000	1 950 000
	650	470	470	509	6	3	8 400	20 900	860 000	2 130 000
	670	500	500	522	6	6	8 900	22 700	910 000	2 320 000

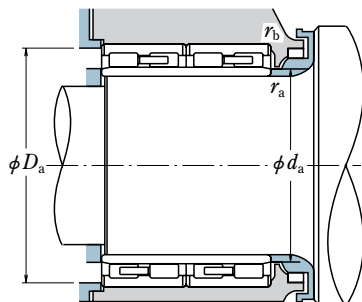

Bearing Numbers	Figure ⁽¹⁾	Abutment and Fillet Dimensions (mm)				Mass (kg) approx.
		d_a	D_a	r_a max.	r_b max.	
370RV4801	1	391	457	2.5	2.5	116
370RV5211	SP	394	500	3	2	263
370RV5401	1	394	513	3	3	311
380RV5001	1	401	477	2.5	2.5	153
380RV5201	1	404	493	3	3	181
380RV5202	1	404	493	3	3	174
380RV5431	4	408	509	4	4	259
380RV5401	3	408	509	4	4	280
380RV5411	8	408	520	4	2	305
380RV5412	SP	408	520	4	2	294
390RV5101	1	412	487	2.5	2.5	156
390RV5521	6	419	519	4	4	303
400RV5202	3	425	493	3	3	136
400RV5501	1	425	523	3	3	212
400RV5612	8	429	529	4	4	308
400RV5613	8M	429	539	4	2	315
400RV5621	6	429	529	4	4	304
400RV5611	8	429	539	4	2	315
406RV6001	1	435	577	4	4	307
410RV6011	8	439	568	4	4	438
420RV5601	1	445	533	3	3	190
420RV5602	6	445	533	3	3	270
420RV6011	8	449	579	4	2	419
430RV5921	5	455	563	3	3	347
440RV6213	8	470	588	4	4	430
440RV6221	5	466	591	3	3	430
450RV6321	5	476	601	3	3	440
460RV6201	1	486	591	3	3	347
460RV6211	8	486	591	3	3	358
460RV6212	8M	486	591	3	3	412
460RV6511	8	496	624	5	2.5	514
460RV6721	7	496	631	5	5	596

Note (1) Refer to pages **B 386** and **B 387**
 The letter "M" indicates bearing for oil mist lubrication.
 The letters "SP" indicate a special design. Please consult NSK for details.

FOUR-ROW CYLINDRICAL ROLLER BEARINGS

RV Type

Bore Diameter 480 – 640 mm

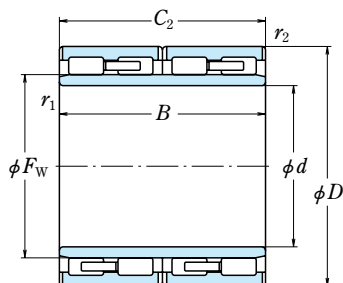

<i>d</i>	Boundary Dimensions (mm)					Basic Load Ratings				
	<i>D</i>	<i>B</i>	<i>C</i> ₂	<i>F</i> _w	<i>r</i> ₁ min.	<i>r</i> ₂ min.	(kN)	(kgf)		
							<i>C</i> _r	<i>C</i> _{0r}	<i>C</i> _r	<i>C</i> _{0r}
480	680	500	500	534	5	5	9 000	23 100	915 000	2 360 000
	680	500	500	534	5	5	9 000	23 100	915 000	2 360 000
	700	400	400	538	6	6	7 650	17 400	780 000	1 780 000
500	670	450	450	540	5	5	8 300	22 300	850 000	2 280 000
	680	420	405	550	5	5	6 700	17 600	685 000	1 790 000
	690	510	510	550	5	5	8 850	23 900	900 000	2 440 000
	690	510	510	552	5	5	9 000	24 600	920 000	2 500 000
	700	515	515	554	5	5	9 100	23 800	930 000	2 430 000
	710	480	480	558	5	5	8 500	21 200	865 000	2 160 000
	720	530	530	560	6	6	9 950	25 300	1 020 000	2 580 000
510	670	320	320	554	5	5	4 950	12 700	505 000	1 290 000
	520	735	535	535	574.5	5	5	10 400	26 300	1 060 000
530	780	570	570	601	6	6	11 800	29 200	1 200 000	2 980 000
	780	570	570	595	6	6	11 800	29 200	1 210 000	2 970 000
536.176	762.03	558.8	558.8	600	5	5	10 800	28 800	1 100 000	2 940 000
	762.03	558.8	558.8	598	spec.	4	11 600	30 000	1 180 000	3 050 000
550	740	510	510	602	5	5	9 150	25 700	935 000	2 620 000
	560	800	600	600	620	6	6	12 400	31 500	1 270 000
570	815	594	594	628	6	6	13 700	33 500	1 390 000	3 450 000
	571.1	812.97	594	594	636	6	5	13 200	34 500	1 350 000
600	820	575	575	660	spec.	3	12 900	35 500	1 310 000	3 650 000
	870	640	640	682	7.5	4	15 700	40 000	1 600 000	4 100 000
	870	640	640	672	7.5	4	15 700	40 000	1 600 000	4 100 000
610	850	570	570	670	6	5	12 600	33 000	1 290 000	3 350 000
	870	660	660	680	6	6	15 400	41 500	1 570 000	4 250 000
634.5	901.87	674	674	705	7.5	4	16 200	43 500	1 650 000	4 450 000
	640	870	610	610	697	6	3	14 200	40 000	1 450 000

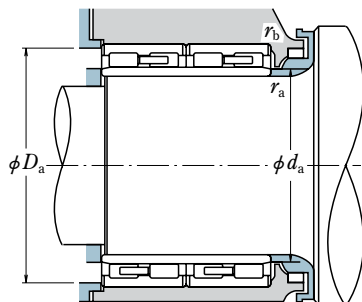

Bearing Numbers	Figure ⁽¹⁾	Abutment and Fillet Dimensions (mm)				Mass (kg) approx.
		d_a	D_a	r_a max.	r_b max.	
480RV6801	7	510	646	4	4	610
480RV6811	8	510	646	4	4	610
480RV7031	9	517	660	5	5	538
500RV6712E	SP	531	637	4	4	464
500RV6812	8	531	646	4	4	451
500RV6913	8M	531	656	4	4	580
500RV6921	7	531	656	4	4	580
500RV7021	7	531	666	4	4	622
500RV7111	8	531	676	4	4	632
500RV7211	8	537	680	5	5	782
510RV6701	1	541	637	4	4	298
520RV7331	9	551	700	4	4	750
530RV7811	8M	568	738	5	5	960
530RV7813	8	568	738	5	5	960
536RV7631	9	568	727	4	4	849
536RV7612E	SP	568	731	5.8	3	849
550RV7411A	8M	582	705	4	4	648
560RV8011	8	598	758	5	5	1 020
570RV8111	8	608	773	5	5	960
571RV8111	8	610	777	5	4	947
600RV8212E	SP	629	790	5.5	2.5	931
600RV8711	8M	645	836	6	3	1 320
600RV8713	8	645	836	6	3	1 320
610RV8511	8	649	813	5	4	1 040
610RV8711	8	649	827	5	5	1 330
634RV9031	9	680	868	6	3	1 440
640RV8711	8M	680	839	5	2.5	1 100

Note (1) Refer to pages **B 386** and **B 387**
 The letter "M" indicates bearing for oil mist lubrication.
 The letters "SP" indicate a special design. Please consult NSK for details.

FOUR-ROW CYLINDRICAL ROLLER BEARINGS

RV Type

Bore Diameter 650 – 850 mm

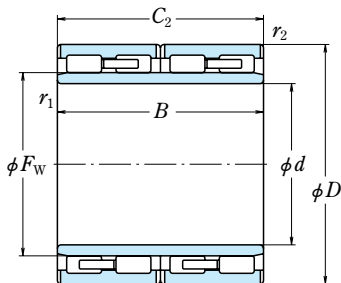

<i>d</i>	Boundary Dimensions (mm)						Basic Load Ratings			
	<i>D</i>	<i>B</i>	<i>C</i> ₂	<i>F</i> _w	<i>r</i> ₁ min.	<i>r</i> ₂ min.	<i>C</i> _r (kN)	<i>C</i> _{0r}	<i>C</i> _r (kgf)	<i>C</i> _{0r}
650	920	670	670	723	7.5	7.5	16 200	44 000	1 660 000	4 500 000
	920	690	690	723	7.5	7.5	16 600	45 000	1 690 000	4 600 000
690	980	715	715	767.5	7.5	7.5	17 900	48 000	1 820 000	4 900 000
	980	750	750	766	7.5	7.5	19 200	53 000	1 960 000	5 400 000
	980	750	750	766	7.5	7.5	19 200	53 000	1 960 000	5 400 000
700	930	620	620	763	6	6	12 900	38 000	1 320 000	3 900 000
	980	700	700	774	6	6	17 800	49 000	1 820 000	5 000 000
710	1 000	715	715	787.5	7.5	7.5	18 700	50 500	1 900 000	5 150 000
725	1 000	700	700	796	6	6	18 200	51 000	1 860 000	5 200 000
	1 000	700	700	796	6	6	17 700	49 500	1 810 000	5 050 000
730	960	620	620	790	6	3	15 000	44 500	1 530 000	4 500 000
	1 030	750	750	809	6	6	20 700	56 500	2 120 000	5 800 000
750	1 000	670	670	813	6	6	16 800	49 500	1 710 000	5 050 000
	1 070	750	750	837	7.5	7.5	21 700	58 500	2 220 000	6 000 000
760	1 030	750	750	834	7.5	7.5	18 200	53 500	1 860 000	5 450 000
	1 080	805	790	845	6	6	22 200	61 000	2 260 000	6 200 000
761.425	1 079.602	787.4	787.4	845	7.5	7.5	22 200	61 000	2 260 000	6 200 000
800	1 080	700	700	878	6	3	19 600	58 000	2 000 000	5 900 000
	1 080	750	750	880	6	6	19 200	56 500	1 950 000	5 750 000
	1 080	750	750	880	6	6	18 700	56 500	1 910 000	5 750 000
820	1 100	745	720	892	6	3	19 700	58 500	2 010 000	6 000 000
	1 130	800	800	903	7.5	7.5	22 900	66 500	2 330 000	6 800 000
	1 130	825	800	903	7.5	7.5	22 900	66 500	2 330 000	6 800 000
	1 160	840	840	911	7.5	7.5	25 600	72 000	2 610 000	7 300 000
840	1 160	840	840	920	2	7.5	24 900	71 000	2 540 000	7 250 000
850	1 150	840	840	928	7.5	4	23 300	68 500	2 370 000	7 000 000
	1 180	650	650	945	7.5	7.5	19 600	53 000	2 000 000	5 400 000
	1 180	850	850	940	7.5	7.5	24 600	72 000	2 510 000	7 350 000
	1 180	875	850	940	7.5	7.5	24 600	72 000	2 510 000	7 350 000

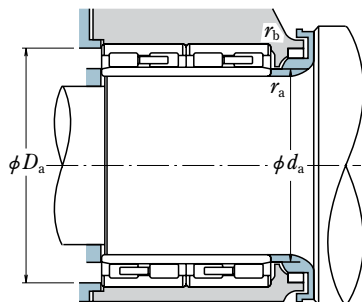

Bearing Numbers	Figure ⁽¹⁾	Abutment and Fillet Dimensions (mm)				Mass (kg) approx.
		d_a	D_a	r_a max.	r_b max.	
650RV9212	8	696	870	6	6	1 470
650RV9211	8	696	870	6	6	1 520
690RV9831	9	737	929	6	6	1 790
690RV9832	9M	737	929	6	6	1 880
690RV9812	8	737	929	6	6	1 880
700RV9311	8	741	885	5	5	1 200
700RV9821	7	741	934	5	5	1 720
710RV1011	8	757	948	6	6	1 840
725RV1011	8	767	954	5	5	1 670
725RV1021	7	767	954	5	5	1 670
730RV9611	8	772	928	5	2.5	1 250
730RV1011	8	772	983	5	5	2 050
750RV1011	8	792	954	5	5	1 520
755RV1011	8	803	1 017	6	6	2 230
760RV1031	9	808	978	6	6	1 880
760RV1032A	9M	802	1 032	5	5	2 430
761RV1032	9	810	1 026	6	6	2 390
800RV1011	8	843	1 045	5	2.5	1 910
800RV1012	8	843	1 032	5	5	2 050
800RV1032	9	843	1 032	5	5	2 050
820RV1132	SP	863	1 065	5	2.5	2 000
820RV1117	8M	870	1 076	6	6	2 510
820RV1134	SP	870	1 076	6	6	2 530
820RV1111A	8	870	1 105	6	6	2 900
840RV1111	8M	866	1 105	2	6	2 790
850RV1114	8	900	1 111	6	3	2 610
850RV1133	9	900	1 125	6	6	2 260
850RV1111	8M	900	1 125	6	6	2 850
850RV1112A	8M	900	1 125	6	6	2 880

Note ⁽¹⁾ Refer to page **B 387**
 The letter “M” indicates bearing for oil mist lubrication.
 The letters “SP” indicate a special design. Please consult NSK for details.

FOUR-ROW CYLINDRICAL ROLLER BEARINGS

RV Type

Bore Diameter 860 – 1 120 mm

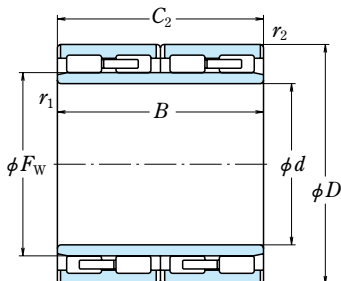

d	D	Boundary Dimensions (mm)					Basic Load Ratings			
		B	C_2	F_w	r_1 min.	r_2 min.	C_r (kN)	C_{0r}	C_r (kgf)	C_{0r}
860	1 130	670	670	934	6	6	18 400	56 500	1 870 000	5 800 000
	1 160	735	710	940	7.5	4	20 400	60 000	2 080 000	6 100 000
900	1 220	840	840	989	7.5	4	26 800	80 000	2 730 000	8 200 000
	1 230	895	870	985	7.5	7.5	25 800	76 000	2 630 000	7 750 000
	1 280	930	930	1 000	7.5	7.5	32 000	89 500	3 250 000	9 100 000
920	1 280	865	850	1 015	7.5	7.5	28 000	80 000	2 860 000	8 150 000
950	1 360	1 000	1 000	1 075	9.5	5	37 500	10 8000	3 800 000	11 000 000
1 120	1 580	1 150	1 150	1 255	9.5	9.5	43 500	13 4500	4 450 000	13 700 000

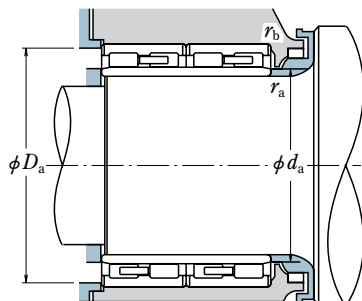

Bearing Numbers	Figure ⁽¹⁾	Abutment and Fillet Dimensions (mm)				Mass (kg) approx.
		d_a	D_a	r_a max.	r_b max.	
860RV1132	9	904	1 081	5	5	1 780
860RV1133	9	910	1 121	6	3	2 200
900RV1212	8	951	1 179	6	3	2 950
900RV1211	8M	951	1 174	6	6	3 200
900RV1213	8	951	1 223	6	6	3 990
920RV1211A	8M	972	1 223	6	6	3 510
950RV1311	8	1 010	1 313	8	4	4 910
1120RV1511	8	1 084	1 509	8	8	7 400

Note ⁽¹⁾ Refer to page **B 387**
 The letter "M" indicates bearing for oil mist lubrication.

DOUBLE-ROW TAPERED ROLLER BEARINGS

KDH (TDI) Type, Steep Angle

Bore Diameter 110 – 305.079 mm

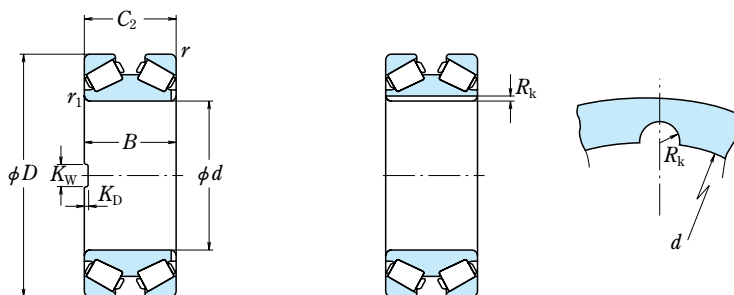

Boundary Dimensions (mm/inch)						Basic Load Ratings (kN) / (kgf)				Bearing Numbers
<i>d</i>	<i>D</i>	<i>B</i>	<i>C</i> ₂	<i>r</i> ₁ min.	<i>r</i> min.	<i>C</i> _a	<i>C</i> _{0a}	<i>C</i> _a	<i>C</i> _{0a}	
110	240	118	118	1	3	605	—	62 000	—	110KDH2401A+K 140KDH2701+K 150KDH3201A+K
140	270	120	120	3	3	585	—	60 000	—	
150	320	144	144	5	4	985	—	100 000	—	
170	360	144	160	2.5	4	1 260	—	129 000	—	170KDH3601+K 190KDH3201A 190KDH3202A+K
190	320	104	104	3	3	620	—	63 500	—	
	320	114	114	3	3	620	—	63 500	—	
200	380	180	180	1.5	4	1 500	—	153 000	—	200KDH3801+K
210	355	130	127	6	3	610	—	62 000	—	210KDH3501A+K 210KDH3501B+K 210KDH4401+K
	355	130	127	5	3	610	—	62 000	—	
	440	175	244	5	6	2 250	—	229 000	—	
220	360	120	120	3	3	745	—	76 000	—	220KDH3601+K 240KDH4601
240	460	140	140	5	5	1 330	—	136 000	—	
260	389.5	105	105	1.5	3	815	—	83 000	—	260KDH3801A+K 260KDH5001+K
	500	180	180	5	5	1 880	—	192 000	—	
279.400 11.0080	482.600 19.0000	177.800 7.0000	177.800 7.0000	6.0	4.8	1 660	—	169 000	—	*279KDH4852
285	380	92	92	1	2.5	545	—	55 500	—	285KDH3802 298KDH4101+K
298	419.5	120	120	1.5	3	845	—	86 000	—	
300	440	105	105	4	4	860	—	87 500	—	300KDH4401 300KDH4401B+K 300KDH5003+K 300KDH5202
	440	105	105	4	4	860	—	87 500	—	
	500	200	200	5	5	1 830	—	186 000	—	
	520	180	180	4	4	1 840	—	187 000	—	
305.003 12.0080	559.867 22.0420	169.980 6.6921	176.350 6.9429	6.4	4.8	2 140	—	218 000	—	*305KDH5551+K
305.069	559.999	200	200	6.5	spec.	2 410	—	246 000	—	305KDH5501+K 305KDH5501B
	559.999	200	200	6.5	9.5	2 410	—	246 000	—	
305.079	500	200	200	6.4	4.8	1 740	—	177 000	—	305KDH5001 305KDH5001C 305KDH5001E+K
	500	200	200	6.4	4.8	1 740	—	177 000	—	
	500	200	200	6.4	4.8	1 740	—	177 000	—	

Note * Bearings marked * are inch design.

Remarks

- Double-row tapered roller bearings with the suffix + K have outer ring spacers.
- C*_a of the basic load ratings is not the limiting load. For this bearing type, apply a preload.

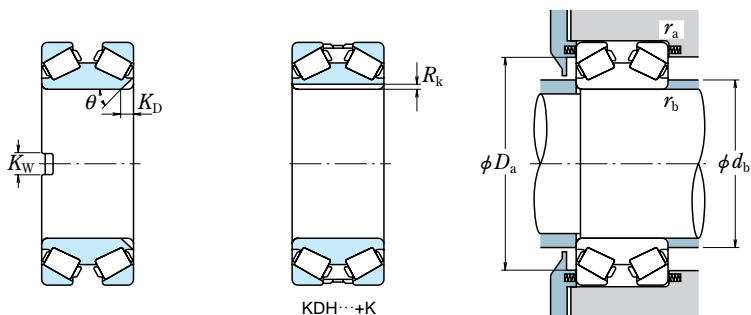

Key Way (mm)	Notches			Abutment and Fillet Dimensions (mm)				Constant	Axial Load Factors			Mass (kg)	
	R_K	K_W (mm)	K_D (mm)	θ ($^\circ$)	$\overset{(!)}{\text{No. ofNotches}}$	d_b	D_a		r_a max.	r_b max.	e		Y_2
—	30	7	90	1X2	126	207	2.5	1	0.81	1.2	0.83	—	24.6
—	—	—	—	—	165	238	2.5	2.5	0.70	1.4	0.97	—	33
—	25	10	90	2X1	176	277	3	4	0.89	1.1	0.76	—	53.4
—	50	7	90	1X2	195	309	3	2	1.1	0.92	0.62	—	70.7
—	50	7	90	1X2	211	290	2.5	2.5	0.76	1.3	0.88	—	31
—	38	12	90	2X2	211	290	2.5	2.5	0.76	1.3	0.88	—	35.2
—	32	15	90	1X2	220	330	3	1.5	0.97	1.0	0.70	—	89.8
—	30	20	45	1X2	241	321	2.5	5	0.59	1.7	1.1	—	53.8
—	30.5	20	45	1X2	240	321	2.5	4	0.59	1.7	1.1	—	53.8
—	51	15	90	2X1	243	384	5	4	1.1	0.92	0.62	—	151
—	40	22	45	1X2	242	325	2.5	2.5	0.88	1.1	0.77	—	45.5
—	50	15	90	2X2	277	407	4	4	0.87	1.2	0.78	—	98.5
—	30	9	90	1X2	277	358	2.5	1.5	0.87	1.2	0.78	—	42.7
—	50	15	90	2X2	296	444	4	4	0.87	1.2	0.78	—	162
—	40	12	90	1X2	310	433	4.8	6.0	0.70	1.4	0.97	—	132
—	32	13	45	1X2	298	358	2	0.8	0.70	1.4	0.97	—	27.3
—	20	8.5	90	1X2	313	388	2.5	1	0.81	1.2	0.83	—	50.6
6.55	—	—	—	—	324	408	3	3	0.87	1.2	0.78	—	49.6
—	32.1	22.22	45	1X2	324	408	3	3	0.87	1.2	0.78	—	52.2
—	50.8	34.92	45	2X2	333	453	4	4	0.76	1.3	0.89	—	161
—	50	30	45	2X2	331	466	3	3	0.81	1.2	0.83	—	152
—	—	—	—	—	340	492	4.8	6.4	0.89	1.1	0.76	—	180
—	50.8	19.05	90	2X2	349	503	—	6.5	1.1	0.93	0.63	—	206
—	50.8	39.69	45	2X2	349	494	9.5	6.5	1.1	0.93	0.63	—	198
9.5	—	—	—	—	335	447	4.8	6.4	0.70	1.4	0.97	—	158
—	51.2	30	45	2X2	335	446	4.8	6.4	0.70	1.4	0.97	—	158
9.5	40	22	45	1X2	335	447	4.8	6.4	0.70	1.4	0.97	—	162

Note (!) (No. of notches) X (No. of faces)

Remarks 3. Please consult with NSK for selection, operation, basic static load ratings (C_{0a}) and axial load factors (Y_0) of bearings.

DOUBLE-ROW TAPERED ROLLER BEARINGS

KDH (TDI) Type, Steep Angle

Bore Diameter 305.079 – 400 mm

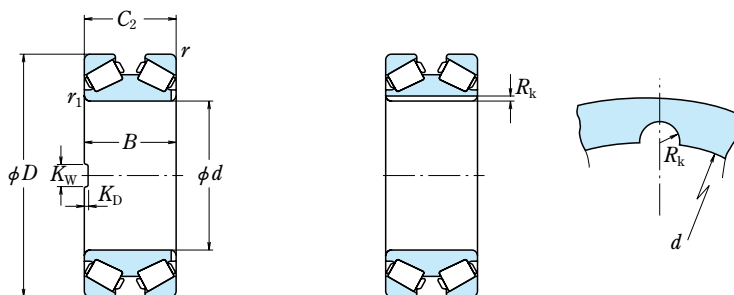

Boundary Dimensions (mm/inch)					Basic Load Ratings (kN) {(kgf)}				Bearing Numbers	
<i>d</i>	<i>D</i>	<i>B</i>	<i>C</i> ₂	<i>r</i> ₁ min.	<i>r</i> min.	<i>C</i> _a	<i>C</i> _{0a}	<i>C</i> _a		<i>C</i> _{0a}
305.079	500	200	200	5	5	1 880	—	191 000	—	305KDH5003A
	500	200	200	6.4	4.8	1 640	—	167 000	—	305KDH5004
	500	200	200	6.4	4.8	1 640	—	167 000	—	305KDH5004A
	500	200	200	5	5	1 640	—	167 000	—	305KDH5004B
	500	200	200	6.4	4.8	1 640	—	167 000	—	305KDH5004D+K
	500	200	200	6.4	4.8	1 640	—	167 000	—	305KDH5004J
	500	200	200	5	5	1 640	—	167 000	—	305KDH5004L
305.08	500	200	200	5	5	1 640	—	167 000	—	305KDH5004C
305.105	559.867	169.98	200	4	spec.	2 170	—	221 000	—	305KDH5502
318	449.5	120	120	2.5	4	945	—	96 000	—	318KDH4401+K
320	560	280	280	5	5	2 230	—	228 000	—	320KDH5602+K
330	458.5	120	120	4	3	1 080	—	111 000	—	330KDH4501+K
	458.5	120	120	3	3	1 080	—	111 000	—	330KDH4502+K
340	590	192	192	5	5	2 130	—	218 000	—	340KDH5901+K
350	618	200	200	6	6	2 480	—	253 000	—	350KDH6101+K
	590	192	192	5	5	2 130	—	218 000	—	350KDH5901+K
360	550	148	148	5	5	1 250	—	127 000	—	360KDH5502+K
370	630	240	240	6	5	2 910	—	297 000	—	370KDH6301+K
380	559.5	160	160	5	5	1 340	—	137 000	—	380KDH5501A+K
	650	240	240	4	6	3 200	—	325 000	—	380KDH6501+K
	650	240	240	3	6	3 800	—	390 000	—	380KDH6502+K
381	695	250	280	4	6	3 950	—	400 000	—	381KDH6901+K
400	650	200	200	6	6	3 000	—	305 000	—	400KDH6501
	650	200	200	6	6	3 000	—	305 000	—	400KDH6501A
	650	200	200	6	6	3 000	—	305 000	—	400KDH6501B
	650	240	192	5	4	3 000	—	305 000	—	400KDH6506
	650	240	240	6	6	3 250	—	330 000	—	400KDH6502
	650	240	240	6	6	3 250	—	330 000	—	400KDH6502A
	650	240	240	6	6	3 250	—	330 000	—	400KDH6502D
	650	240	240	6	6	3 250	—	330 000	—	400KDH6502J
	650	240	240	5	6	3 250	—	330 000	—	400KDH6502L
	650	240	240	5	6	3 200	—	325 000	—	400KDH6504
	650	240	240	6	6	3 200	—	325 000	—	400KDH6505
780	280	300	7.5	7.5	5 500	—	560 000	—	400KDH7802+K	

- Remarks**
1. Double-row tapered roller bearings with the suffix + K have outer ring spacers.
 2. *C*_a of the basic load ratings is not the limiting load. For this bearing type, apply a preload.
 3. Please consult with NSK for selection, operation, basic static load ratings (*C*_{0a}) and axial load factors (*Y*₀) of bearings.

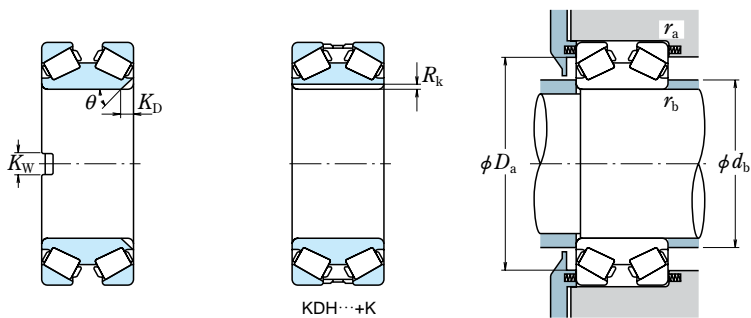

KDH...+K

Key Way (mm) R_K	Notches			Abutment and Fillet Dimensions (mm)				Constant e	Axial Load Factors			Mass (kg) approx.
	K_W (mm)	K_D (mm)	θ (°) (¹) No. of Notches	d_b	D_a	r_a max.	r_b max.		Y_2	Y_3	Y_0	
8.05	51.3	34.92	45 1X2	340	450	4	4	0.82	1.2	0.82	—	160
9.5	50.8	34.9	45 1X2	337	447	4.8	6.4	0.70	1.4	0.97	—	157
—	50.8	34.9	45 1X2	337	447	4.8	6.4	0.70	1.4	0.97	—	157
8.05	51.3	34.92	45 1X2	337	446	4	4	0.70	1.4	0.97	—	157
—	32	34.9	45 1X2	337	447	4.8	6.4	0.70	1.4	0.97	—	161
—	50.8	34.9	45 2X2	337	447	4.8	6.4	0.70	1.4	0.97	—	157
8.05	51.5	35	45 1X2	337	447	4	4	0.70	1.4	0.97	—	156
—	51.5	35	45 2X2	337	447	4	4	0.70	1.4	0.97	—	156
—	—	—	—	337	484	—	3	1.1	0.89	0.60	—	193
—	20	8.5	90 1X2	336	415	3	2	0.87	1.2	0.78	—	57.5
—	50	20	90 1X2	360	499	4	4	0.67	1.5	1.0	—	309
—	32	12	90 1X2	350	423	2.5	3	1.1	0.96	0.64	—	58.5
—	50	15	45 1X2	350	424	2.5	2.5	1.1	0.96	0.64	—	59
9.5	—	—	—	380	535	4	4	0.70	1.4	0.97	—	225
—	50	20	90 2X2	395	556	5	5	0.87	1.2	0.78	—	256
—	—	—	—	385	535	4	4	0.70	1.4	0.97	—	217
—	50	15	90 1X2	394	505	4	4	0.71	1.4	0.95	—	132
—	34	20	90 2X2	409	568	4	5	0.81	1.2	0.83	—	315
—	—	—	—	410	512	4	4	0.70	1.4	0.96	—	136
—	50	15	90 2X2	417	583	5	3	0.87	1.2	0.78	—	340
—	50.8	40	45 2X2	417	579	5	2.5	1.1	0.96	0.64	—	335
—	50	30	45 2X2	422	620	5	3	0.87	1.2	0.78	—	454
11.3	—	—	—	438	586	5	5	1.1	0.96	0.64	—	245
—	50.8	19	90 1X2	438	586	5	5	1.1	0.96	0.64	—	245
12.5	—	—	—	438	586	5	5	1.1	0.96	0.64	—	245
—	63.6	35	90 1X2	438	591	3	4	1.1	0.96	0.64	—	250
12.5	—	—	—	437	589	5	5	0.87	1.2	0.78	—	301
23	64.3	32	45 2X2	437	589	5	5	0.87	1.2	0.78	—	301
—	64.3	32	45 1X2	437	589	5	5	0.87	1.2	0.78	—	301
—	63.6	32	45 1X2	437	589	5	5	0.87	1.2	0.78	—	301
40	64.3	32	45 1X2	436	589	5	4	0.87	1.2	0.78	—	301
—	63.6	32	45 1X2	439	586	5	4	0.87	1.2	0.78	—	301
12.5	64.2	41.3	90 1X2	439	585	5	5	0.87	1.2	0.78	—	308
—	50	25	90 2X2	455	680	6	6	1.3	0.80	0.54	—	628

Note (¹) (No. of notches) X (No. of faces)

DOUBLE-ROW TAPERED ROLLER BEARINGS

KDH (TDI) Type, Steep Angle

Bore Diameter 440 – 1 200 mm

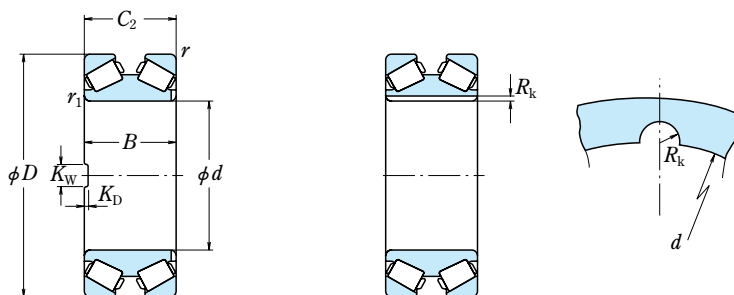

Boundary Dimensions (mm/inch)						Basic Load Ratings (kN) {kgf}				Bearing Numbers
<i>d</i>	<i>D</i>	<i>B</i>	<i>C</i> ₂	<i>r</i> ₁ min.	<i>r</i> min.	<i>C</i> _a	<i>C</i> _{0a}	<i>C</i> _a	<i>C</i> _{0a}	
440	650	155	155	6	6	1 930	—	197 000	—	440KDH6501+K
450	820	300	300	7.5	7.5	5 500	—	560 000	—	450KDH8201+K
	830	288	320	7.5	7.5	5 750	—	585 000	—	450KDH8301A+K
460	618	150	150	5	4	1 670	—	170 000	—	460KDH6101+K
	470	720	216	216	5	4	3 050	—	310 000	—
480	689.5	180	180	6	6	2 230	—	228 000	—	480KDH6801+K
482.600	733.425	200.000	200.000	6.4	17.4	2 710	—	276 000	—	*482KDH7351
	19.0000	28.8750	7.8740							
500	820	256	256	7.5	7.5	3 400	—	345 000	—	500KDH8201+K
510	733.5	200.025	200.025	3.3	4.8	2 530	—	258 000	—	510KDH7301
	800	285	285	7.5	7.5	4 450	—	450 000	—	510KDH8001A
510.13	800	285	285	7.5	7.5	4 450	—	450 000	—	510KDH8003A
	560	820	242	242	4	6	3 100	—	315 000	—
600	1 000	350	350	7.5	7.5	6 800	—	690 000	—	600KDH1001C+K
635	940	260	260	2.5	5	4 700	—	475 000	—	635KDH9401
	940	260	260	3.3	6.4	5 200	—	530 000	—	635KDH9402
635.08	939.9	305.5	305.5	2.5	5	5 400	—	550 000	—	635KDH9301
685.800	939.800	234.950	227.813	3.3	6.4	3 900	—	400 000	—	*685KDH9351
	27.0000	9.2500	8.9690							
785	1 150	285	285	3	6	5 800	—	590 000	—	785KDH1101
900	1 220	340	340	2.5	6	5 900	—	600 000	—	900KDH1251
1 200	1 500	230	230	7.5	7.5	4 650	—	475 000	—	1200KDH1501

Note * Bearings marked * are inch design.

Remarks

1. Double-row tapered roller bearings with the suffix + K have outer ring spacers.
2. *C*_a of the basic load ratings is not the limiting load. For this bearing type, apply a preload.
3. Please consult with NSK for selection, operation, basic static load ratings (*C*_{0a}) and axial load factors (*Y*₀) of bearings.

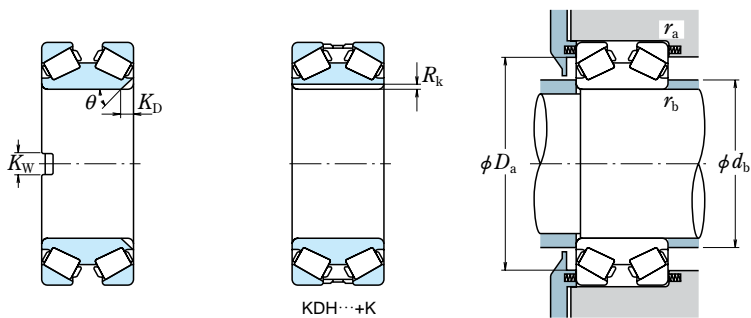

Key Way (mm)	Notches			Abutment and Fillet Dimensions (mm)				Constant	Axial Load Factors			Mass (kg)	
	R_K	K_W (mm)	K_D (mm)	θ ($^\circ$)	⁽¹⁾ No. of Notches	d_b	D_a		r_a max.	r_b max.	e		Y_2
—	50	15	90	2X2	475	599	5	5	0.87	1.2	0.78	—	178
14.5	40	25	90	2X2	508	732	6	6	1.1	0.96	0.64	—	683
	50	20	90	2X2	505	733	6	6	1.1	0.96	0.64	—	745
—	50	15	90	2X2	484	575	3	4	1.1	0.96	0.64	—	123
—	50	20	90	1X2	503	660	3	4	0.87	1.2	0.78	—	319
—	50	15	90	2X1	514	638	5	5	0.87	1.2	0.78	—	218
—	50.8	19.05	90	2X2	518	660	17.4	6.4	0.78	1.3	0.87	—	285
—	—	—	—	—	549	749	6	6	0.61	1.7	1.1	—	546
—	50.8	38.1	45	2X2	546	677	4.8	3.3	0.82	1.2	0.82	—	270
—	70	40	45	1X2	549	725	6	6	0.87	1.2	0.78	—	511
13	70	40	45	1X2	550	725	6	6	0.87	1.2	0.78	—	511
—	50	25	45	1X2	596	757	5	3	0.72	1.4	0.94	—	430
15	50	25	90	1X1	657	897	6	6	0.87	1.2	0.78	—	1 120
—	70.3	51	45	1X2	678	872	4	2	0.87	1.2	0.78	—	592
—	70.3	51	45	1X2	676	866	6.4	3.3	1.1	0.92	0.62	—	578
—	70.3	50.8	45	1X2	690	862	4	2	0.87	1.2	0.78	—	726
—	63.5	38.1	45	2X2	722	875	6.4	3.3	0.87	1.2	0.78	—	460
—	90	50	60	2X1	847	1 072	5	2.5	0.87	1.2	0.78	—	966
—	89.5	51	45	1X2	942	1 141	5	2	0.78	1.3	0.86	—	1 120
—	70.3	45	45	1X2	1 253	1 421	6	6	1.1	0.96	0.64	—	991

Note ⁽¹⁾ (No. of notches) X (No. of faces)

DOUBLE-DIRECTION TAPERED ROLLER THRUST BEARINGS

TFD Type

Bore Diameter 120 – 900 mm

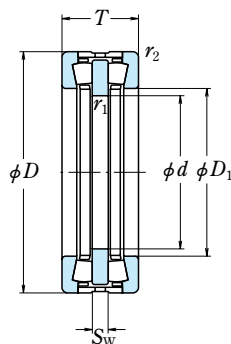

<i>d</i>	Boundary Dimensions (mm)				Basic Load Ratings (kN) (kgf)		Bearing Numbers
	<i>D</i>	<i>T</i>	<i>r</i> ₁ min.	<i>r</i> ₂ min.	<i>C</i> _a	<i>C</i> _a	
120	250	95	1.1	3	640	65 000	120TFD2501
130	280	125	1.1	3	1 020	104 000	130TFD2801
160	225	78	1	1.5	325	33 500	160TFD2201
170	240	84	1	2	395	40 000	170TFD2401
180	280	90	1	2	640	65 000	180TFD2801
	400	200	2	4	1 970	201 000	180TFD4001
190	330	120	1.1	2	1 110	113 000	190TFD3301
200	280	96	0.6	2.1	495	50 500	200TFD2801
220	300	96	1	2	460	47 000	220TFD3001
230	410	150	2	4	1 450	148 000	230TFD4101
240	320	96	0.6	2.1	565	58 000	240TFD3201
250	380	100	1.1	1.1	1 010	103 000	250TFD3801
260	360	92	1	2	620	63 500	260TFD3601
	420	100	1.5	1.5	935	95 000	300TFD4201
320	440	108	1.5	3	980	100 000	320TFD4401
	470	130	1.1	3	1 290	131 000	320TFD4701
350	490	130	1.1	3	1 350	137 000	350TFD4901
	540	135	3	3	1 790	182 000	350TFD5401
380	560	130	1.5	3	1 470	150 000	380TFD5601
420	620	170	1.5	3	2 460	251 000	420TFD6201
440	660	155	3	5	2 430	248 000	440TFD6601
450	645	155	4	4	2 280	233 000	450TFD6401
460	680	155	2	4	2 450	250 000	460TFD6801
470	720	200	2	4	3 200	330 000	470TFD7201
530	710	218	2	3	2 500	255 000	530TFD7101
550	760	230	2	5	2 770	283 000	550TFD7601
	760	230	5	2	3 200	325 000	550TFD7602
600	910	290	6	6	5 200	530 000	600TFD9101
670	900	230	3	6	3 700	380 000	670TFD9001
900	1 180	220	2	6	4 450	455 000	900TFD1101

- Remarks**
1. *C*_a of the basic load ratings is not the limiting load. For this bearing type, it is recommended to apply a preload.
 2. Please consult with NSK for selection and operation of bearings.

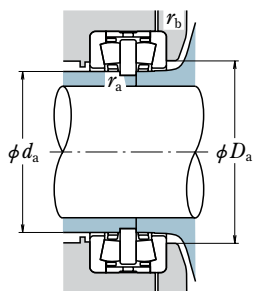

Dimensions (mm)		Abutment and Fillet Dimensions (mm)				Mass (kg)
S_w	D_1	d_a	D_a	r_a max.	r_b max.	approx.
20	145	144	161	1	2.5	21.9
30	163	150	178	1	2.5	36.8
18	175	169	180	1	1.5	9.3
20	184	180	190	1	2	11.6
20	196	191	202	1	2	19.8
50	212	208	222	2	3	122
26	215	206	226	1	2	41.9
22	216	210	222	0.6	2	17.7
22	240	233	246	1	2	19.1
34	270	264	280	2	3	82.8
22	256	249	262	0.6	2	20.6
22	275	264	280	1	1	39.2
20	285	273	290	1	2	27.3
23	330	321	335	1.5	1.5	41.4
26	355	344	363	1.5	2.5	47.2
30	350	335	358	1	2.5	73.8
30	390	375	398	1	2.5	73.2
30	400	385	408	2.5	2.5	109
32	430	410	438	1.5	2.5	105
35	465	450	473	1.5	2.5	169
35	505	485	517	2.5	4	180
38	490	472	500	3	3	159
30	510	496	520	2	3	186
40	535	508	545	2	3	285
57	575	555	583	2	2.5	233
50	610	576	622	2	4	303
50	590	574	596	4	2	303
70	680	660	696	5	5	650
50	725	700	740	2.5	5	398
48	990	955	1 005	2	5	614

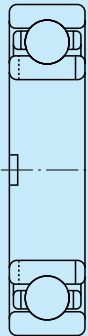
Figures of Typical Deep Groove Ball Bearings**Figure 1****Figure 2****Figure 3****Figure 4**

Figures of Typical Angular Contact Ball Bearings

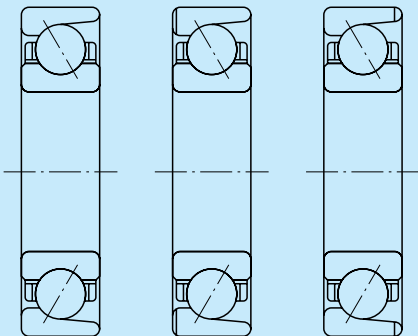

Figure 1

Figure 2

Figure 3

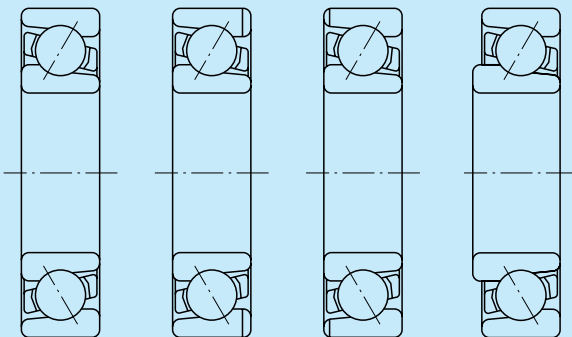

Figure 4

Figure 5

Figure 6

Figure 7

SINGLE-ROW DEEP GROOVE BALL BEARINGS

Bore Diameter 145 – 250 mm

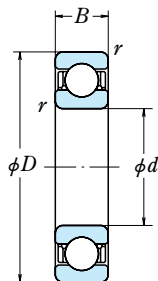

Boundary Dimensions (mm)				Basic Load Ratings (kN) (kgf)				Factor	Bearing Numbers	Figure ⁽¹⁾
d	D	B	r min.	C_r	C_{0r}	C_r	C_{0r}	f_0		
145	220	38	2.1	132	124	13 500	12 700	15.6	B145-1	1
150	230	35	2.1	126	126	12 800	12 800	15.9	B150-6	1
	279	45	3	176	168	18 000	17 100	15.1	B150-8	1
160	229.5	33	2	108	111	11 000	11 300	16.3	B160-51	2
	229.5	36	2	108	111	11 000	11 300	16.3	B160-4	1
	249.5	38	2.1	147	143	15 000	14 600	15.8	B160-3	1
170	249.5	38	2	135	137	13 800	13 900	16.1	B170-13	1
	254.5	38	2.1	153	154	15 600	15 700	15.9	B170-51	1
180	259.5	33	2	140	147	14 300	15 000	16.2	B180-3	1
	265	33	2	140	147	14 300	15 000	16.2	B180-10	1
185	269.5	38	2	158	166	16 100	17 000	16.1	B185-1	1
190	259.5	33	2	113	127	11 500	13 000	16.6	B190-3A	1
	269.5	33	2.1	145	157	14 700	16 000	16.3	B190-5	1
	269.5	33	2.1	145	157	14 700	16 000	16.3	B190-5A	2
	279.5	38	2.1	143	158	14 600	16 100	16.4	B190-12	1
200	279.5	38	2.1	143	158	14 600	16 100	16.4	6940X	1
	289.5	38	2.1	162	179	16 600	18 200	16.3	B200-1	1
210	299.5	38	2.1	167	191	17 100	19 400	16.4	B210-4	1
220	309.5	38	2.1	176	202	18 000	20 600	16.3	B220-2	1
	319.5	46	2.1	201	234	20 500	23 900	16.1	B220-51	1
	319.5	50	2.1	135	166	13 800	17 000	16.8	B220-7	1
230	329.5	38	2.1	181	216	18 500	22 000	16.5	B230-7	1
	329.5	40	2.1	191	227	19 500	23 100	16.3	B230-5	1
	329.5	40	2.1	191	227	19 500	23 100	16.3	B230-6A	2
	339.5	45	3	224	266	22 800	27 200	16.0	B230-51	2
240	329.5	38	2.1	154	191	15 700	19 400	16.8	B240-8	1
	329.5	40	2.1	180	217	18 400	22 100	16.5	B240-7	1
	336	38	2.1	154	191	15 700	19 400	16.8	B240-13	1
250	349.5	46	2.1	205	253	20 900	25 800	16.4	B250-3	1

Notes ⁽¹⁾ Refer to page **B 410**

Dynamic Equivalent Load

$$P = X F_r + Y F_a$$

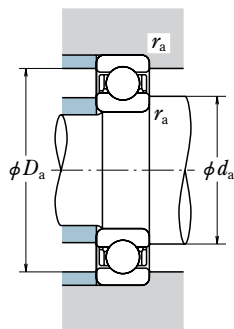

Static Equivalent Load

$$\frac{F_a}{F_r} > 0.8, P_0 = 0.6 F_r + 0.5 F_a$$

$$\frac{F_a}{F_r} \leq 0.8, P_0 = F_r$$

$\frac{f_0 F_r}{C_{0r}}$	e	$\frac{F_a}{F_r} \leq e$		$\frac{F_a}{F_r} > e$	
		X	Y	X	Y
		0.172	0.19	1	0
0.345	0.22	1	0	0.56	1.99
0.689	0.26	1	0	0.56	1.71
1.03	0.28	1	0	0.56	1.55
1.38	0.30	1	0	0.56	1.45
2.07	0.34	1	0	0.56	1.31
3.45	0.38	1	0	0.56	1.15
5.17	0.42	1	0	0.56	1.04
6.89	0.44	1	0	0.56	1.00

Abutment and Fillet Dimensions (mm)			Mass (kg)
d_a	D_a	r_a max.	approx.
163	204	2	5.15
168	214	2	5.42
170	260	2.5	13
176	216	2	4.45
176	216	2	4.76
178	233	2	6.96
187	235	2	6.27
189	238	2	6.88
197	245	2	5.82
197	250	2	6.41
202	255	2	7.24
207	245	2	5.09
210	253	2	6.09
210	253	2	6.06
210	263	2	8.08
220	263	2	7.21
220	272	2	8.41
230	282	2	8.57
241	292	2	9.07
241	302	2	12.2
241	302	2	13.4
251	312	2	11
251	312	2	11.4
251	312	2	11.3
253	319	2.5	14
262	312	2	9.85
262	312	2	9.99
262	318	2	10.8
272	331	2	13.6

SINGLE-ROW DEEP GROOVE BALL BEARINGS

Bore Diameter 260 – 500 mm

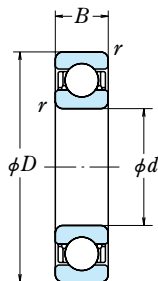

Boundary Dimensions (mm)				Basic Load Ratings (kN) / (kgf)				Factor	Bearing Numbers	Figure ⁽¹⁾
d	D	B	r min.	C_r	C_{0r}	C_r	C_{0r}	f_0		
260	369.5	46	2.1	211	270	21 500	27 600	16.5	B260-2 B260-14 B260-51 6052X1	1
	369.5	50	2.1	143	195	14 600	19 800	17.1		1
	379.5	56	4	253	320	25 800	32 500	16.0		2
	399.5	65	4	291	375	29 700	38 500	15.8		1
270	379.5	46	2.1	237	310	24 200	31 500	16.3	B270-2	1
280	389.5	46	2.1	216	288	22 000	29 300	16.6	B280-5 6056X1	1
	419.5	65	4	300	410	31 000	41 500	16.0		1
290	400	52	4	243	330	24 800	33 500	16.5	B290-1 B290-2 B290-5 B290-52	1
	409.5	56	3	270	370	27 600	37 500	16.3		1
	409.5	60	3	203	275	20 700	28 100	16.9		1
	419.5	60	5	277	375	28 300	38 500	16.2		2
300	419.5	56	3	269	370	27 400	38 000	16.4	6960X B305-1	1
	444.5	70	4	310	440	32 000	45 000	16.1		1
310	429.5	60	4	267	370	27 300	38 000	16.4	B310-2	1
320	449.5	56	3	266	375	27 100	38 000	16.5	B320-3	1
340	449.5	56	3	245	355	25 000	36 000	16.8	B340-5 B340-51X B340-51 B340-2	1
	479.5	65	4	320	475	32 500	48 500	16.4		1
	480	65	4	320	475	32 500	48 500	16.4		1
	540	90	5	440	665	45 000	68 000	15.7		1
360	509.5	70	5	365	550	37 000	56 000	16.2	B360-6 6072X1	1
	539.5	82	5	460	720	47 000	73 500	15.7		1
390	549.5	80	4	390	630	40 000	64 500	16.4	B390-5	1
400	720	130	6	630	1 080	64 000	110 000	15.5	B400-3	3
420	559.5	65	4	340	570	35 000	58 500	16.8	6948X1	1
440	599	80	4	425	720	43 000	73 500	16.5	B440-3	1
450	629	80	4	420	725	43 000	74 000	16.5	B450-2	4
480	689.5	95	6	545	980	55 500	100 000	16.2	B480-3	1
500	689	100	6	540	980	55 500	100 000	16.2	B500-11 B500-3	1
	700	90	5	495	915	50 500	93 500	16.5		1

Notes ⁽¹⁾ Refer to page B 410

Dynamic Equivalent Load

$$P = XF_r + YF_a$$

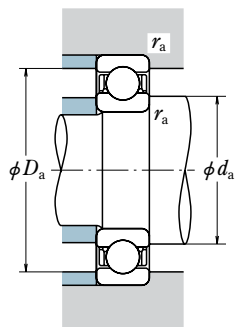

Static Equivalent Load

$$\frac{F_a}{F_r} > 0.8, P_0 = 0.6F_r + 0.5F_a$$

$$\frac{F_a}{F_r} \leq 0.8, P_0 = F_r$$

$\frac{f_0 F_r}{C_{0r}}$	e	$\frac{F_a}{F_r} \leq e$		$\frac{F_a}{F_r} > e$	
		X	Y	X	Y
		0.172	0.19	1	0
0.345	0.22	1	0	0.56	1.99
0.689	0.26	1	0	0.56	1.71
1.03	0.28	1	0	0.56	1.55
1.38	0.30	1	0	0.56	1.45
2.07	0.34	1	0	0.56	1.31
3.45	0.38	1	0	0.56	1.15
5.17	0.42	1	0	0.56	1.04
6.89	0.44	1	0	0.56	1.00

Abutment and Fillet Dimensions (mm)			Mass (kg)
d_a	D_a	r_a max.	approx.
282	351	2	16.1
282	351	2	17.6
288	356	3	21
288	375	3	29.3
293	361	2	16.8
303	370	2	17.1
308	395	3	31.1
319	376	3	19.3
316	388	2.5	22.9
316	388	2.5	24.7
323	391	4	26.8
326	398	2.5	23.8
334	419	3	35.8
340	405	3	25.6
347	427	2.5	28.5
368	427	2.5	23.2
371	454	3	36.3
371	454	3	36.5
375	509	4	78.2
396	479	4	44.5
396	509	4	65
423	522	3	58.7
444	680	5	236
454	532	3	43.4
475	571	3	63.6
485	600	3	78.6
527	650	5	114
548	649	5	106
541	666	4	106

SINGLE-ROW DEEP GROOVE BALL BEARINGS

Bore Diameter 510 – 850 mm

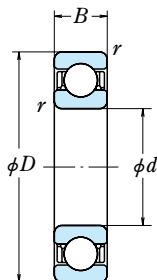

Boundary Dimensions (mm)				Basic Load Ratings (kN) / (kgf)				Factor	Bearing Numbers	Figure ⁽¹⁾
d	D	B	r min.	C_r	C_{0r}	C_r	C_{0r}	f_0		
510	728	125	3	560	1 050	57 000	107 000	16.3	B510-2 B530-1 B540-2	3
530	760	100	6	620	1 180	63 500	121 000	16.2		1
540	800	115	6	645	1 270	65 500	130 000	16.3		4
550	740	90	5	510	980	52 000	100 000	16.7	B550-2 60/560X B570-3	1
560	819.5	115	6	735	1 500	75 000	153 000	16.2		1
570	799	115	6	705	1 400	72 000	143 000	16.1		1
590	868	140	3	725	1 510	74 000	154 000	16.3	B590-1 B600-15	3
600	869	110	7.5	725	1 510	74 000	154 000	16.3		1
610	849.5	100	6	660	1 370	67 000	140 000	16.5	B610-7 B610-3	1
	869	120	6	725	1 520	74 000	155 000	16.3		3
700	979	150	6	765	1 740	78 000	177 000	16.6	B700-1 B725-1 B760-1	3
725	999	150	6	760	1 740	77 500	178 000	16.7		3
760	1 080	150	7.5	775	1 860	79 000	189 000	16.8		1
820	1 160	160	7.5	790	1 970	80 500	201 000	17.0	B820-1 B820-1A B820-1C	3
	1 160	160	7.5	790	1 970	80 500	201 000	17.0		3
	1 160	160	7.5	790	1 970	80 500	201 000	17.0		1
840	1 159	140	7.5	810	2 070	83 000	211 000	17.0	B840-1 B850-2	3
850	1 178	160	7.5	810	2 080	82 500	212 000	17.0		1

Notes ⁽¹⁾ Refer to page B 410

Dynamic Equivalent Load

$$P = XF_r + YF_a$$

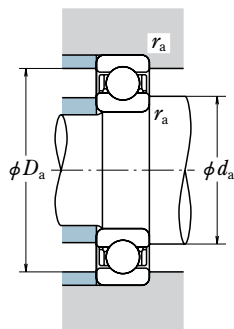

Static Equivalent Load

$$\frac{F_a}{F_r} > 0.8, P_0 = 0.6F_r + 0.5F_a$$

$$\frac{F_a}{F_r} \leq 0.8, P_0 = F_r$$

$\frac{f_0 F_r}{C_{0r}}$	e	$\frac{F_a}{F_r} \leq e$		$\frac{F_a}{F_r} > e$	
		X	Y	X	Y
		0.172	0.19	1	0
0.345	0.22	1	0	0.56	1.99
0.689	0.26	1	0	0.56	1.71
1.03	0.28	1	0	0.56	1.55
1.38	0.30	1	0	0.56	1.45
2.07	0.34	1	0	0.56	1.31
3.45	0.38	1	0	0.56	1.15
5.17	0.42	1	0	0.56	1.04
6.89	0.44	1	0	0.56	1.00

Abutment and Fillet Dimensions (mm)			Mass (kg)
d_a	D_a	r_a max.	approx.
544	687	2.5	159
579	719	5	147
589	758	5	199
593	705	4	109
610	777	5	203
620	757	5	173
628	825	2.5	282
658	820	6	217
662	807	5	173
662	826	5	225
756	933	5	348
782	953	5	338
824	1 027	6	451
887	1 105	6	547
887	1 105	6	547
887	1 105	6	547
907	1 104	6	450
918	1 123	6	535

MATCHED ANGULAR CONTACT BALL BEARINGS

Bore Diameter 120 – 185 mm

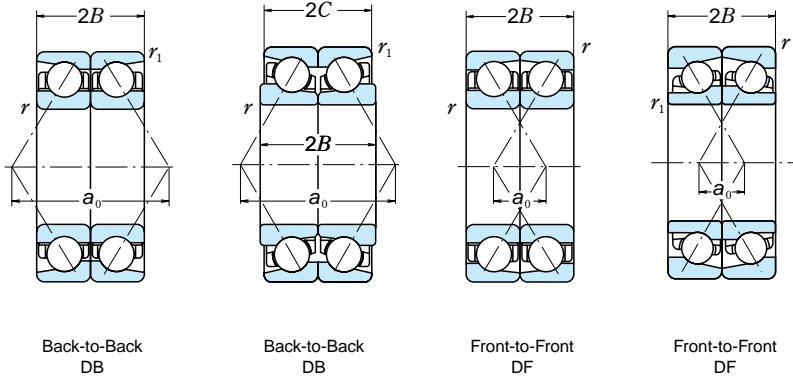

d	Boundary Dimensions (mm)					Basic Load Ratings (Matched)				Bearing Numbers ⁽¹⁾		Figure ⁽²⁾
	D	$2B$	$2C$	r min.	r_1 ⁽³⁾ min.	C_r (kN)	C_{0r} (kgf)	C_r (kgf)	C_{0r} (kgf)	Single	Matched	
120	190	66	66	2	2	187	236	19 000	24 100	BA120-4	DB —	4
	190	66	66	2	2	187	236	19 000	24 100	BA120-4E	DB —	5
140	209.5	66	66	2	1	194	265	19 800	27 000	7028AX	DB DF	1
	209.5	66	66	2	1	174	239	17 700	24 400	7028BX	DB DF	1
	220	56	56	2	—	199	278	20 300	28 400	BA140-52	— DF	1
145	220	76	76	2.1	—	233	300	23 700	30 500	BA145-1	— DF	1
150	224.5	70	70	2.1	1.1	222	305	22 700	31 500	BA150-4E	DB —	2
	225	73	73	2.1	1.1	222	305	22 700	31 500	BA150-1	DB —	1
	225	73	73	2.1	2.1	222	305	22 700	31 500	BA150-1A	— DF	4
	229.9	70	70	2.1	1.1	247	335	25 200	34 000	BA150-2A	DB —	5
	230	70	70	2.1	1.1	247	335	25 200	34 000	BA150-2	DB —	4
	230	70	70	2.1	2.1	247	335	25 200	34 000	BA150-2a	DB —	5
	230	70	70	2.1	1.1	247	335	25 200	34 000	BA150-3	DB —	1
160	235	76	76	2.1	1.1	271	360	27 600	36 500	BA150-7	DB —	1
	279	90	90	3	1.1	405	560	41 000	57 000	BA150-9	DB —	1
	215	56	50	1.5	1.5	144	238	14 700	24 300	BA160-7	DB —	7
170	215	56	50	1.5	1	128	213	13 100	21 800	BT160-3	DB —	7
	219.5	56	56	2	1	156	241	15 900	24 600	7932AAX	DB DF	4
	229.5	66	66	2	1	175	253	17 800	25 800	BT160-51	DB —	2
	249.5	76	76	2.1	—	252	355	25 700	36 000	BA160-3	— DF	3
	249.5	76	76	2.1	1.1	252	355	25 700	36 000	BA160-3E	DB —	2
	240	56	56	2	—	147	241	15 000	24 600	BT170-1	— DF	3
175	249.5	76	76	2.1	1.1	257	370	26 200	38 000	BA170-3	DB —	1
	254.5	76	76	2.1	1.1	275	385	28 000	39 000	BA170-51	— DF	4
	235	60	54	2	1	146	242	14 900	24 700	BT175-1	DB —	7
180	280	92	92	2.1	1.1	325	480	33 500	49 000	BA175-1	— DF	6
	249.5	66	66	2	1	213	335	21 700	34 000	7936AAX	DB DF	4
185	259.5	66	66	2	1	262	390	26 700	40 000	BA180-2	DB —	1
	259.5	66	66	2	1	262	390	26 700	40 000	BA180-2E	DB —	2
	259.5	66	66	2	—	262	390	26 700	40 000	BA180-2E1	— DF	3
	265	66	66	2	1	233	350	23 800	36 000	BT180-2	DB —	5
	269.5	76	76	2	2	288	425	29 300	43 000	BA185-1	DB —	4

Note (1) The suffixes A, AA and B of 79 and 70 series represent contact angles of 30° and 40° respectively. The prefixes BA and BT represent contact angles of 30° and 40° respectively.

(2) Refer to page **B 411**

(3) Bearings, whose r_1 column have a dash (—), are DF combinations and their inner rings are deep groove type. Use r (min.) for the r_1 value.

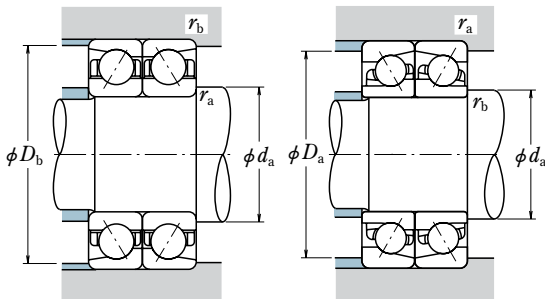

Dynamic Equivalent Load $P = X F_r + Y F_a$

Contact Angle	e	DB or DF			
		$F_a/F_r \leq e$		$F_a/F_r > e$	
		X	Y	X	Y
30°	0.80	1	0.78	0.63	1.24
40°	1.14	1	0.55	0.57	0.93

Static Equivalent Load $P_0 = X_0 F_r + Y_0 F_a$

Contact Angle	DB or DF	
	X ₀	Y ₀
30°	1	0.66
40°	1	0.52

Load Center Spacings (mm)		Abutment and Fillet Dimensions (mm)						Mass (kg)
DB	DF	d _a	d _b ⁽⁴⁾	D _a	D _b	r _a max.	r _b ⁽⁵⁾ max.	
122.5	—	136	—	—	176	2	2	6.75
122.5	—	136	—	—	176	2	2	6.75
134.0	68.0	156	—	195	199	2	1	7.72
179.8	113.8	156	—	195	199	2	1	7.83
—	75.9	156	—	205	—	2	—	8.09
—	67.7	164	—	203	—	2	—	9.97
143.3	—	169	—	—	213	2	1	9.29
144.8	—	169	—	—	213	2	1	9.74
—	71.8	—	169	208	—	2	2	9.36
144.2	—	169	—	—	218	2	1	10.1
144.2	—	169	—	—	218	2	1	10.2
144.2	—	169	—	—	213	2	2	10.1
144.7	—	169	—	—	218	2	1	10.5
149.1	—	169	—	—	223	2	1	12.2
166.3	—	171	—	—	266	2.5	1	25.1
133.3	—	176	—	—	201	1.5	1.5	4.98
182.3	—	176	—	—	204	1.5	1	5.23
137.7	81.7	177	173	205	209	2	1	5.8
196.6	—	177	—	—	219	2	1	8.66
—	77.5	179	—	232	—	2	—	13.7
153.5	—	179	—	—	237	2	1	13.6
—	139.8	188	—	225	—	2	—	8.3
159.2	—	190	—	—	237	2	1	12.3
—	84.7	—	185	237	—	2	1	12.7
199.0	—	193	—	—	224	2	1	6.68
—	85.3	—	190	262	—	2	1	20.6
157.1	91.1	198	194	234	238	2	1	9.01
160.0	—	198	—	—	248	2	1	11.4
160.0	—	198	—	—	248	2	1	11.4
—	94.0	198	—	244	—	2	—	11.4
219.7	—	198	—	—	253	2	1	12
169.3	—	203	—	—	254	2	2	13.8

- Note** (4) For bearings that are listed for both the DB and DF arrangements, if a dash (—) appears in the d_b column, use the value in the d_a column, use the value in the d_a column.
 (5) If a dash (—) appears in the r_b (max.) column, use the value in the r_a (max.) column.

MATCHED ANGULAR CONTACT BALL BEARINGS

Bore Diameter 190 – 240 mm

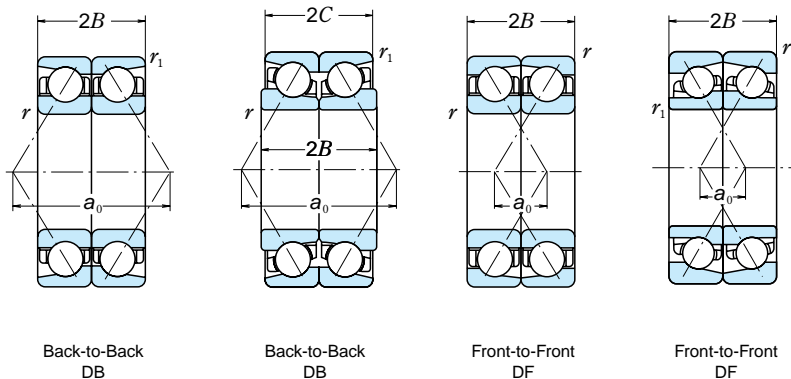

<i>d</i>	Boundary Dimensions (mm)					Basic Load Ratings (Matched)				Bearing Numbers ⁽¹⁾		Figure ⁽²⁾
	<i>D</i>	<i>2B</i>	<i>2C</i>	<i>r</i> min.	<i>r</i> ₁ ⁽³⁾ min.	<i>C_r</i>	<i>C_{0r}</i>	<i>C_r</i>	<i>C_{0r}</i>	Single	Matched	
190	255	66	58	1.1	1.1	179	305	18 200	31 500	BT190-1	DB —	7
	269.5	66	66	2.1	—	266	410	27 200	41 500	BA190-1	— DF	1
	269.5	66	66	2.1	1.1	266	410	27 200	41 500	BA190-1E	DB —	2
	269.5	66	66	2.1	—	266	410	27 200	41 500	BA190-1E2	— DF	3
	269.5	66	66	2.1	2.1	266	410	27 200	41 500	BA190-4	DB —	4
195	270	70	70	2	—	249	405	25 400	41 000	BA195-1	— DF	3
199	280	76	76	2.1	1.1	278	445	28 300	45 500	BA199-1A	DB —	2
200	279.5	76	76	2.1	1.1	278	445	28 300	45 500	7940AAX	DB DF	4
	279.5	76	76	2.1	1.1	247	400	25 200	40 500	7940BAX	DB DF	4
	289.5	76	76	2.1	1.1	299	465	30 500	47 500	BA200-3	DB —	4
	289.5	76	76	2.1	1.1	299	465	30 500	47 500	BA200-3E	DB —	5
	289.5	76	76	2.1	1.1	267	420	27 200	42 500	BT200-1E	— DF	6
210	299.5	76	76	2.1	1.1	280	465	28 600	47 500	BA210-2	DB —	1
220	300	76	70	1	1.5	231	405	23 500	41 500	BT220-1	DB —	7
	309.5	76	76	2.1	1.1	335	545	34 000	56 000	BA220-1	DB DF	1
	309.5	76	76	2.1	1.1	335	545	34 000	56 000	BA220-1A	DB —	2
	309.5	76	76	2.1	—	335	545	34 000	56 000	BA220-1B	— DF	3
	309.5	76	76	2.1	—	297	490	30 500	50 000	BT220-2A	— DF	3
	309.5	76	76	2.1	1.1	297	490	30 500	50 000	BT220-2E	DB —	2
	319.5	92	92	2.1	1.1	335	560	34 500	57 000	BT220-51	DB DF	4
	329.5	100	100	2.1	—	415	690	42 500	70 500	BA220-2	— DF	3
	329.5	102	102	3	1.1	370	620	38 000	63 500	BT220-3	DB —	1
225	345	112	112	3	—	460	790	46 500	80 500	BA225-1	— DF	1
230	320	80	80	2.1	—	300	535	30 500	54 500	BA230-1	— DF	3
	329.5	80	80	2.1	1.1	360	615	37 000	62 500	BA230-2	DB —	1
	329.5	80	80	2.1	1.1	360	615	37 000	62 500	BA230-2A	DB —	5
	329.5	80	80	2.1	1.1	360	615	37 000	62 500	BA230-2B	DB —	4
	339.5	90	90	3	1.1	370	625	37 500	63 500	BT230-51	DB —	2
240	329.5	80	80	2.1	—	292	520	29 800	53 000	BA240-1	— DF	3
	329.5	80	80	2.1	1.1	305	535	31 000	54 500	BT240-1	DB DF	6
	329.5	80	80	2.1	1.1	305	535	31 000	54 500	BT240-1E	DB —	5
	339.5	80	80	3	1.1	290	495	29 600	50 500	BT240-2	DB —	1
	359.5	112	112	3	1.1	435	780	44 500	79 500	7048BX	DB DF	1

Note (1) The suffixes A, AA and B of 79 and 70 series represent contact angles of 30° and 40° respectively. The prefixes BA and BT represent contact angles of 30° and 40° respectively.

(2) Refer to page **B 411**

(3) Bearings, whose *r*₁ column have a dash (—), are DF combinations and their inner rings are deep groove type. Use *r* (min.) for the *r*₁ value.

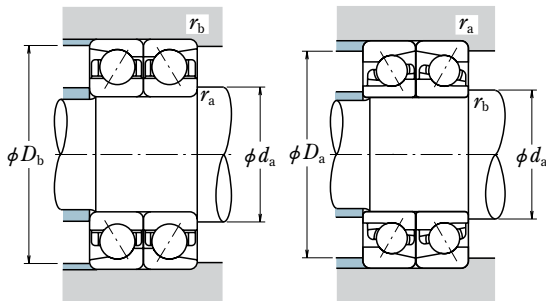

Dynamic Equivalent Load $P = X F_r + Y F_a$

Contact Angle	e	DB or DF			
		$F_a/F_r \leq e$		$F_a/F_r > e$	
		X	Y	X	Y
30°	0.80	1	0.78	0.63	1.24
40°	1.14	1	0.55	0.57	0.93

Static Equivalent Load $P_0 = X_0 F_r + Y_0 F_a$

Contact Angle	DB or DF	
	X_0	Y_0
30°	1	0.66
40°	1	0.52

Load Center Spacings (mm)		Abutment and Fillet Dimensions (mm)						Mass (kg)
DB	DF	d_a	$d_b^{(4)}$	D_a	D_b	r_a max.	$r_b^{(5)}$ max.	
215.2	—	205	—	—	243	1	1	8.69
—	99.8	211	—	252	—	2	—	11.8
165.8	—	211	—	—	257	2	1	11.8
—	99.8	211	—	252	—	2	—	11.8
165.8	—	211	—	—	252	2	2	11.6
—	99.2	214	—	254	—	2	—	12
176.6	—	220	—	—	267	2	1	14.1
176.6	100.6	221	216	262	267	2	1	13.3
239.4	163.4	221	216	262	267	2	1	13.6
179.5	—	221	—	—	276	2	1	16
179.5	—	221	—	—	276	2	1	16
—	167.6	—	216	271	—	2	1	16.2
185.2	—	231	—	—	286	2	1	16.9
252.5	—	236	—	—	285	1	1.5	14.6
191.0	115.0	242	—	291	296	2	1	17.8
191.0	—	242	—	—	296	2	1	17.8
—	115.0	242	—	291	—	2	—	17.9
—	184.4	242	—	291	—	2	—	17.8
260.4	—	242	—	—	296	2	1	18.2
272.6	180.6	242	237	301	306	2	1	23.5
—	108.8	242	—	311	—	2	—	29.9
281.8	—	244	—	—	316	2.5	1	30.3
—	108.5	249	—	324	—	2.5	—	37.4
—	121.7	252	—	301	—	2	—	19.5
201.7	—	252	—	—	316	2	1	22.7
201.7	—	252	—	—	316	2	1	21.7
201.7	—	252	—	—	316	2	1	21.2
284.1	—	254	—	—	325	2.5	1	27.1
—	124.5	263	—	311	—	2	—	20.1
279.1	199.1	263	257	311	316	2	1	19.4
279.1	—	263	—	—	316	2	1	19.7
283.3	—	265	—	—	325	2.5	1	22.7
307.7	195.7	265	—	338	345	2.5	1	39.5

Note (4) For bearings that are listed for both the DB and DF arrangements, if a dash (—) appears in the d_b column, use the value in the d_a column, use the value in the d_a column.
 (5) If a dash (—) appears in the r_b (max.) column, use the value in the r_a (max.) column.

MATCHED ANGULAR CONTACT BALL BEARINGS

Bore Diameter 250 – 580 mm

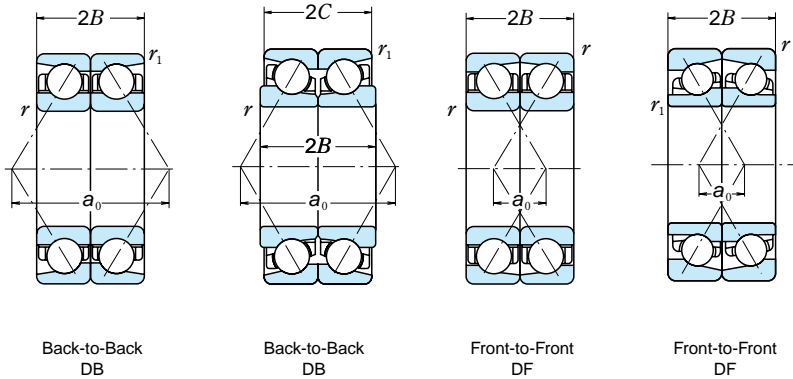

<i>d</i>	Boundary Dimensions (mm)					Basic Load Ratings (Matched)				Bearing Numbers ⁽¹⁾		Figure ⁽²⁾	
	<i>D</i>	<i>2B</i>	<i>2C</i>	<i>r</i> min.	<i>r</i> ₁ min.	<i>C_r</i>	<i>C_{0r}</i>	<i>C_r</i>	<i>C_{0r}</i>	Single	Matched		
250	340	76	70	0.6	2	274	515	27 900	52 500	BT250-2	DB	—	7
	349.5	92	92	3	1.1	355	640	36 000	65 000	BT250-51	DB	—	1
260	369.5	92	92	2.1	1.1	415	770	42 000	78 500	BA260-1	DB	DF	1
	369.5	92	92	2.1	1.1	395	720	40 000	73 000	BT260-51	DB	—	4
	369.5	92	92	2.1	2.1	395	720	40 000	73 000	BT260-51aE	—	DF	6
	379.5	112	112	4	2	430	785	44 000	80 000	BT260-52	DB	—	2
270	399.5	130	130	4	1.5	505	945	51 500	96 500	7052BX	DB	DF	1
	379.5	92	92	2.1	1.1	400	750	41 000	76 500	BT270-1	DB	—	6
277	420	130	130	4	1.5	530	1 040	54 000	106 000	BT277-1	DB	—	1
280	389.5	92	92	2.1	1.1	380	740	38 500	75 500	BT280-51	DB	—	1
	400	104	104	4	1.5	425	820	43 500	84 000	BT280-2	DB	—	2
285	380	92	92	3	2	297	570	30 500	58 000	BT285-1	DB	—	4
290	409.5	112	112	3	1.1	485	920	49 500	94 000	BA290-2	DB	—	1
	409.5	112	112	3	1.1	430	830	44 000	84 500	BT290-2	DB	—	1
	419.5	120	120	5	2	475	935	48 500	95 500	BT290-52	DB	—	2
300	419.5	112	112	3	1.1	510	1 000	52 000	102 000	7960AX	DB	DF	1
	419.5	112	112	3	1.1	455	900	46 000	92 000	7960BAX	DB	DF	4
310	429.5	120	120	4	1.5	520	1 040	53 000	107 000	BA310-2	DB	—	1
	429.5	120	120	4	1.5	460	940	47 000	95 500	BT310-51	DB	—	1
320	449.5	112	112	3	3	540	1 130	55 000	115 000	BA320-1	DB	—	1
	449.5	112	112	3	1.1	480	1 010	49 000	103 000	BT320-51	DB	—	6
340	480	130	130	4	1.5	535	1 150	54 500	117 000	BT340-51	DB	—	1
	540	180	180	5	2	780	1 720	79 500	176 000	BT340-1	DB	—	2
360	509.5	140	140	5	2	615	1 340	63 000	137 000	BT360-3	—	DF	4
380	519.5	130	130	4	1.5	565	1 300	57 500	132 000	7976BX	DB	DF	1
	540	164	164	5	2	680	1 500	69 500	153 000	BA380-1	DB	—	1
	540	164	164	5	2	610	1 350	62 000	138 000	BT380-1	DB	—	1
420	559.5	130	130	4	1.5	590	1 440	60 000	147 000	7984BX	DB	DF	1
580	780	160	160	5	2	910	2 700	93 000	276 000	BA580-1	DB	—	1

Note (1) The suffixes A, AA and B of 79 and 70 series represent contact angles of 30° and 40° respectively. The prefixes BA and BT represent contact angles of 30° and 40° respectively.

(2) Refer to page **B 411**

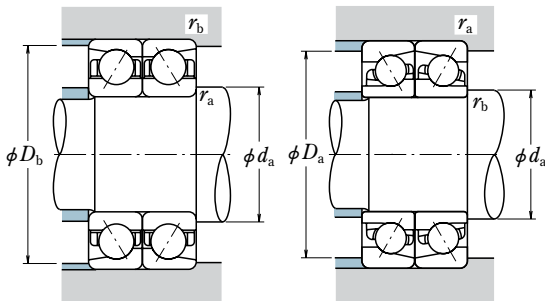

Dynamic Equivalent Load $P = X F_r + Y F_a$

Contact Angle	e	DB or DF			
		$F_a/F_r \leq e$		$F_a/F_r > e$	
		X	Y	X	Y
30°	0.80	1	0.78	0.63	1.24
40°	1.14	1	0.55	0.57	0.93

Static Equivalent Load $P_0 = X_0 F_r + Y_0 F_a$

Contact Angle	DB or DF	
	X_0	Y_0
30°	1	0.66
40°	1	0.52

Load Center Spacings (mm)		Abutment and Fillet Dimensions (mm)						Mass (kg)
DB	DF	d_a	$d_b^{(3)}$	D_a	D_b	r_a max.	r_b max.	
281.9	—	266	—	—	323	0.6	2	19
297.7	—	275	—	—	335	2.5	1	26.8
227.6	135.6	283	—	350	355	2	1	31.5
310.3	—	283	—	—	355	2	1	30.9
—	218.3	—	283	350	—	2	2	30.9
324.5	—	290	—	—	362	3	2	41.5
341.9	211.9	290	—	373	382	3	1.5	57.6
318.7	—	294	—	—	365	2	1	31.7
358.7	—	307	—	—	402	3	1.5	63.1
327.1	—	304	—	—	374	2	1	34.4
337.3	—	310	—	—	383	3	1.5	41.5
325.0	—	311	—	—	362	2.5	2	28.5
258.1	—	317	—	—	394	2.5	1	44.2
349.7	—	317	—	—	394	2.5	1	45.3
357.9	—	325	—	—	401	4	2	54
263.8	151.8	327	—	397	404	2.5	1	48.6
358.1	246.1	327	320	397	404	2.5	1	46.7
273.6	—	342	—	—	412	3	1.5	52.5
370.5	—	342	—	—	412	3	1.5	52.2
278.3	—	348	—	—	426	2.5	2.5	55.4
379.1	—	348	—	—	433	2.5	1	54.4
409.0	—	373	—	—	461	3	1.5	71.6
459.2	—	377	—	—	519	4	2	161
—	295.0	—	385	477	—	4	2	85
442.6	312.6	414	—	491	500	3	1.5	81.1
347.6	—	419	—	—	519	4	2	115
468.2	—	419	—	—	519	4	2	116
476.2	346.2	456	—	530	539	3	1.5	88.3
472.6	—	627	—	—	754	4	2	217

Note ⁽³⁾ For bearings that are listed for both the DB and DF arrangements, if a dash (—) appears in the d_b column, use the value in the d_a column.

TAPERED ROLLER THRUST BEARINGS

TFX Type For Adjusting Screws

Outside Diameter 149.225 – 533.400 mm

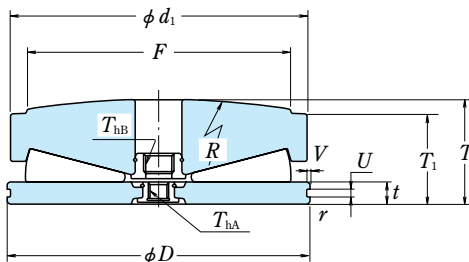

<i>D</i>	Boundary Dimensions (mm/inch)				Basic Load Ratings (kN) (kgf)	
	<i>d</i> ₁	<i>F</i> min.	<i>T</i>	<i>T</i> ₁	<i>C</i> _{0a}	<i>C</i> _{0a}
149.225 5.875	146.86 5.782	127.0 5.000	54.97 2.164	47.62 1.875	2 520	257 000
174.625 6.875	172.26 6.782	152.4 6.000	61.39 2.417	52.37 2.062	3 650	375 000
203.200 8.000	200.84 7.907	177.8 7.000	75.62 2.977	65.07 2.562	4 850	495 000
220.000 8.661	220.00 8.661	195.0 7.677	78.00 3.071	66.00 2.598	6 100	620 000
266.700 10.500	264.34 10.407	228.6 9.000	94.41 3.717	81.00 3.189	8 350	855 000
320.675 12.625	318.31 12.532	279.4 11.000	110.97 4.369	95.25 3.750	12 600	1 280 000
377.825 14.875	375.46 14.782	330.2 13.000	129.01 5.079	111.12 4.375	17 700	1 810 000
404.400 15.921	407.21 16.032	355.6 14.000	142.23 5.600	122.22 4.812	20 500	2 090 000
409.575 16.125	407.21 16.032	355.6 14.000	142.23 5.600	122.22 4.812	20 500	2 090 000
438.150 17.250	435.79 17.157	381.0 15.000	150.67 5.932	130.18 5.125	22 200	2 260 000
471.000 18.543	453.00 17.835	390.0 15.354	145.54 5.730	124.00 4.882	24 100	2 460 000
482.600 19.000	480.21 18.906	381.0 15.000	145.54 5.730	130.18 5.125	27 700	2 820 000
495.300 19.500	492.94 19.407	431.8 17.000	170.61 6.717	146.05 5.750	31 500	3 200 000
523.875 20.625	521.52 20.532	457.2 18.000	176.66 6.955	153.29 6.035	34 500	3 500 000
533.400 21.000	531.01 20.906	457.0 17.992	177.80 7.000	161.92 6.375	34 500	3 500 000

Bearing Numbers	Dimensions (mm)							Mass (kg) approx.
	R	t	r min.	U	V	T_{hA}	T_{hB}	
149TFX01	457.2	12.70	1.6	4.8	1.2	M12X	—	6.6
174TFX01	457.2	12.70	1.6	4.8	1.2	M12	M18	10.1
203TFX01	508.0	15.88	1.6	6.3	1.2	M12	M18	16.8
220TFX01	550.0	15.88	1.5	6.3	1.2	M12	—	20.3
266TFX01	609.6	19.05	1.6	7.9	2.0	M20	—	36
320TFX01	762.0	22.22	1.5	10.3	2.4	M24	—	61.5
377TFX01	914.4	25.40	1.5	10.3	2.4	M24	M30	98.7
407TFX01	1 016.0	28.57	3.3	—	—	M24	M30	127
409TFX01	1 016.0	28.57	3.3	9.5	2.5	M24	M30	128
438TFX01	1 016.0	31.75	3.2	13.5	3.2	M24	M36	155
471TFX01	1 100.0	38.10	3.5	—	—	M24	M36	174
482TFX01	1 905.0	38.10	1.6	13.5	3.2	M24	M36	184
495TFX01	1 066.8	34.92	3.3	13.5	3.2	M24	M30	225
523TFX01	1 270.0	34.92	3.3	13.5	3.2	M24	M36	261
533TFX01	1 981.2	31.75	1.6	9.5	9.5	M24	M36	273

Remark Please consult with NSK for selection and operation of bearings.

TAPERED ROLLER THRUST BEARINGS

TFX Type For Adjusting Screws

Outside Diameter 555.625 – 900 mm

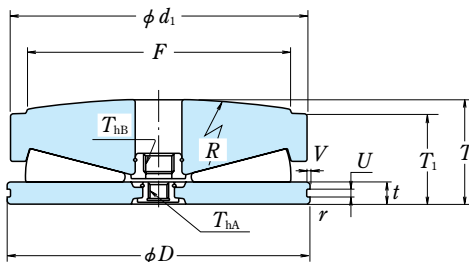

<i>D</i>	Boundary Dimensions (mm/inch)				Basic Load Ratings	
	<i>d</i> ₁	<i>F</i> min.	<i>T</i>	<i>T</i> ₁	<i>C</i> _{0a} (kN)	<i>C</i> _{0a} (kgf)
555.625 21.875	553.26 21.782	482.6 19.000	191.15 7.525	165.10 6.500	38 000	3 900 000
581.025 22.875	578.66 22.782	508.0 20.000	193.78 7.629	168.28 6.625	41 500	4 200 000
581.025 22.875	578.66 22.782	508.0 20.000	196.65 7.742	168.28 6.625	41 500	4 200 000
609.600 24.000	607.24 23.907	533.4 21.000	204.01 8.032	177.80 7.000	47 000	4 800 000
609.600 24.000	607.24 23.907	533.4 21.000	204.01 8.032	170.01 6.693	47 000	4 800 000
641.350 25.250	638.99 25.157	558.8 22.000	212.67 8.373	184.15 7.250	51 500	5 250 000
692.150 27.250	689.75 27.155	495.3 19.500	311.45 12.262	280.00 11.024	59 500	6 050 000
710	710	480	260	235	54 500	5 600 000
800	800	700	250	206	71 500	7 300 000
847.6	841	650	250	212	79 000	8 050 000
900	930	750	275	231	93 000	9 500 000

Bearing Numbers	Dimensions (mm)							Mass (kg) approx.
	R	t	r min.	U	V	T_{hA}	T_{hB}	
555TFX01	1 270.0	38.10	3.3	12.7	3.2	M24	—	318
581TFX01	1 422.4	38.10	3.2	13.5	3.2	M24	M42	353
581TFX02	1 308.1	38.10	3.3	13.5	3.2	8UNC	7UNC	358
609TFX01	1 524.0	38.10	3.3	13.5	3.2	M30	M42	409
609TFX03	1 524.0	38.10	3.3	13.5	3.2	M24	M42	409
641TFX01	1 524.0	38.10	3.3	13.5	3.2	M24	M42	472
692TFX01	1 803.4	38.10	3.0	13.5	3.2	M24	M42	805
710TFX01	1 400	40	4	—	—	M24	M24	706
800TFX01	1 524	43	7	—	—	M36	M48	857
847TFX01	1 652	43	5	—	—	M42	M42	966
930TFX01	1 800	60	4	—	—	M36	M48	1 270

Remark Please consult with NSK for selection and operation of bearings.

TAPERED ROLLER THRUST BEARINGS

TFV Type For Adjusting Screws

Outside Diameter 149.225 – 555.625 mm

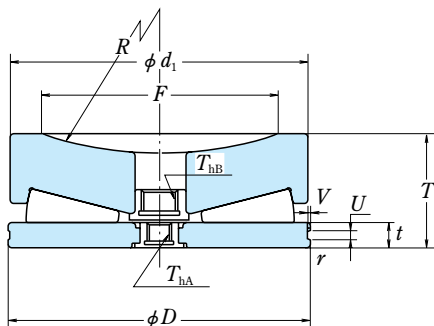

<i>D</i>	Boundary Dimensions (mm/inch)			Basic Load Ratings (kN) (kgf)		Bearing Numbers
	<i>d</i> ₁	<i>F</i> min.	<i>T</i>	<i>C</i> _{0a}	<i>C</i> _{0a}	
149.225 5.875	146.86 5.782	127.0 5.000	47.62 1.875	2 520	257 000	149TV01
203.200 8.000	200.80 7.905	177.8 7.000	65.07 2.562	4 850	495 000	203TFV01
266.700 10.500	264.34 10.407	228.6 9.000	80.95 3.187	8 400	855 000	266TFV01
266.700 10.500	264.34 10.407	228.6 9.000	86.37 3.400	8 350	855 000	266TFV02
320.675 12.625	318.31 12.532	279.4 11.000	95.25 3.750	12 600	1 280 000	320TFV01
377.825 14.875	375.46 14.782	330.2 13.000	111.12 4.375	17 700	1 810 000	377TFV01
409.575 16.125	407.21 16.032	355.6 14.000	122.22 4.812	20 500	2 090 000	409TFV01
438.150 17.250	435.79 17.157	381.0 15.000	130.18 5.125	22 200	2 260 000	438TFV01
495.300 19.500	492.94 19.407	431.8 17.000	146.05 5.750	31 500	3 200 000	495TFV01
508.000 20.000	501.65 19.750	341.3 13.438	165.10 6.500	31 000	3 150 000	508TFV01
523.875 20.625	521.51 20.532	457.2 18.000	152.40 6.000	34 500	3 500 000	523TFV01
551.600 21.716	539.75 21.250	435.5 17.146	158.75 6.250	35 000	3 550 000	551TFV01
554	555	414	190.5	38 000	3 900 000	554TFV01
554.000 21.811	555.00 21.850	465.4 18.324	190.50 7.500	38 000	3 900 000	554TFV01A
555.625 21.875	553.26 21.782	482.6 19.000	165.10 6.500	38 000	3 900 000	555TFV01

Remark Please consult with NSK for selection and operation of bearings.

<i>R</i>	<i>t</i>	Dimensions (mm)					Mass (kg) approx.
		<i>r</i> min.	<i>U</i>	<i>V</i>	<i>T</i> _{hA}	<i>T</i> _{hB}	
228.6	12.70	1.6	4.8	1.2	M12X	—	5.6
254.0	15.88	1.6	6.3	1.2	—	—	14.3
304.8	19.05	1.6	7.9	2.0	M20	—	30.8
250.0	19.05	1.6	7.9	2.0	M20	—	35.5
381.0	22.22	1.5	10.3	2.4	M24	—	52.3
457.2	25.40	1.5	10.3	2.4	M24	M30	84.7
508.0	28.58	3.2	10.3	2.4	M24	M30	109
508.0	31.75	3.2	13.5	3.2	M24	M36	133
558.8	34.92	3.3	13.5	3.2	M24	M36	191
508.0	34.92	3.2	12.7	3.2	M24	M36	228
635.0	34.92	3.2	13.5	3.2	M24	M36	223
635.0	24.65	4.0	10.6	2.5	M24	M42	258
1 270	50	3	9.5	6.0	M24	—	312
1 270.0	50.00	3.0	—	—	M24	M42	312
635.0	38.10	3.2	13.5	3.2	M24	M36	272

TAPERED ROLLER THRUST BEARINGS

TFV Type For Adjusting Screws

Outside Diameter 581.025 – 880 mm

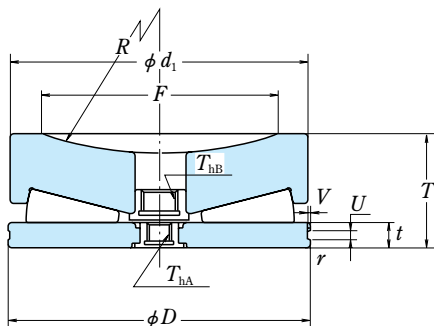

D	Boundary Dimensions (mm/inch)			Basic Load Ratings (kN) (kgf)		Bearing Numbers
	d_1	F min.	T	C_{0a}	C_{0a}	
581.025 22.875	578.66 22.782	508.0 20.000	168.28 6.625	41 500	4 200 000	581TFV01
609.600 24.000	607.24 23.907	533.4 21.000	177.80 7.000	47 000	4 800 000	609TFV01
615.2	607	400	243.92	47 000	4 800 000	615TFV01
641.350 25.250	638.99 25.157	558.8 22.000	184.15 7.250	51 500	5 250 000	641TFV01
880	930	627	234.95	93 000	9 500 000	930TFV01

Remark Please consult with NSK for selection and operation of bearings.

<i>R</i>	<i>t</i>	Dimensions (mm)					<i>T_{hA}</i>	<i>T_{hB}</i>	Mass (kg) approx.
		<i>r</i> min.	<i>U</i>	<i>V</i>					
711.2	38.10	3.2	13.5	3.2	M24	M42	303		
762.0	38.10	3.3	13.5	3.2	M30	M42	353		
635	38.1	3	13.5	3.5	M30	—	493		
762.0	38.10	3.2	13.5	3.2	M24	M42	405		
1 524	50	4	—	—	M42	M42	1 090		

Figures of Typical Back-up Roll Bearings for Sendzimir Mills

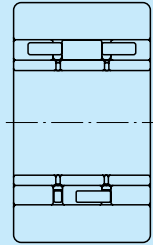

Figure 1

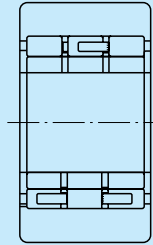

Figure 2

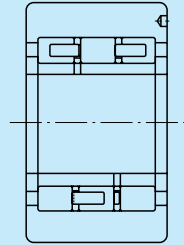

Figure 3

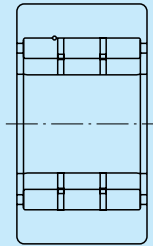

Figure 4

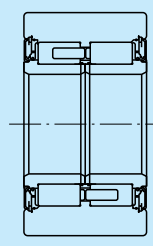

Figure 5

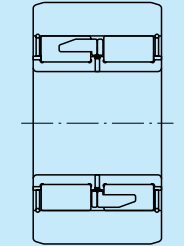

Figure 6

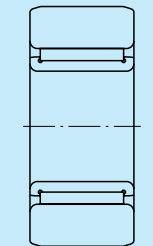

Figure 7

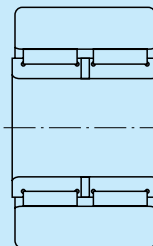
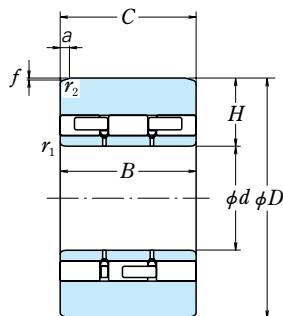

Figure 8

BACK-UP ROLL BEARINGS

For Sendzimir Mills

Bore Diameter 31.75 – 180 mm



d	Boundary Dimensions (mm)					Basic Load Ratings	
	D	B, B_2	C	r_1 min.	r_2	(kN) C_r	(kgf) C_r
31.75	76.2	46.23	45.85	1	0.8	91.0	9 300
50	110	56	56	1.1	2	179	18 200
55	120	26	26	1.6	1.6	74.5	7 600
70	120	52.2	52	1.6	1.6	159	16 200
	160	90	90	1.1	1.5	410	42 000
90	220	120	120	1	2	655	67 000
	220	130	130	1	2	680	69 500
100	225	120	120	2	3	715	73 000
120	300	160	160	2.5	2.5	1 180	120 000
130	300	160	159.5	2	2	1 470	150 000
	300	160	159.5	2	7	1 320	135 000
	300	172.64	170	2	2.5	1 240	126 000
	300	172.64	172.64	2	5	1 540	157 000
	300	172.64	172.64	2	5	1 540	157 000
179.984	406.4	224	220.66	3	3.3	1 950	199 000
180	406.42	171.04	171.04	2.1	5	2 060	210 000
	406.4	217	217	2.1	2.5	2 550	260 000
	406.4	224	220	2.1	2.5	2 050	209 000
	406.42	224	224	2.1	2.5	2 610	266 000

- Remarks**
1. C_r of the basic load ratings is not the limiting load.
 2. Please consult with NSK for selection and operation of bearings.

Bearing Numbers	Figure ⁽¹⁾	Outer Ring Edge Bevel (mm)		Radial Thickness When Delivered (mm)		Model No. of Mill	Brg. Quantity Per Mill	Mass (kg) approx.
		<i>a</i>	<i>f</i>	<i>H</i>				
2S31Z-4	8	—	—	22.200	+0.010 0	ZR34-7 1/2 ZR34-10 ZR34-12 1/2	24 32 40	1.2
3U50-1A	4	6	0.010	29.980	+0.010 0	—	—	3.0
S55-2	7	—	—	32.500		ZR16-11 1/2	10	1.6
S55-1	7	7	0.040	32.500		ZR16-11 1/2	16	3.4
3PL70-1	1	6	0.026	45.000	-0.018 -0.048	ZR33-13 ZR33B-18	— 32	10.7
3U90-1	2	6	0.010	64.980	+0.010 0	—	—	27.7
3U90-4	3	6	0.010	64.982	+0.010 -0.010	—	—	30
3PL100-1A	1	8	0.093	62.470	+0.010 0	ZR23-25 ZR23-31	32 40	28
3U120-4	3	12	0.007	89.966	+0.010 -0.010	—	—	69.4
3PL130-2C	1	9	0.210	84.950	+0.010 0	ZR22B-40	40	66.8
2L130-2E	6	9	0.210	84.950	+0.010 0	ZR22B-40	40	62.8
2U130-16	5	50	0.009	84.950	+0.030 0	ZR22-50	48	71.2
3PL130-1C	1	10	0.131	84.950	+0.010 0	ZR22-50	48	72.4
3PL130-1F	1	10	0.131	84.950	+0.010 0	ZR22B-42 ZR22-50 ZR22B-50	40 48 48	72.4
2U179Z-3	5	15.9	0.093	113.205	0 -0.015	ZR21A-44 ZR21B-62	32 48	168
3PL180-3	1	25	0.145	113.155	0 -0.010	—	—	130
3PL180-1B	1	10	0.058	113.160	0 -0.015	ZS07-60 ZS07-75 ZR21A-62 ZR21B-62	24 56 48 48	165
3U180-2	2	10	0.058	113.160	0 -0.012	ZR21B-60 ZR21B-62	48 48	167
3PL180-2	1	10	0.058	113.210	0 -0.012	—	—	171

Note (1) Refer to page B 433



TRIPLE-RING BEARINGS FOR PAPER MAKING MACHINES

Bore Diameter 180 – 380mm B438

Design, Types, and Features

Controlled crown rolls (CC rolls) having adjustable camber are used extensively for bottom press rolls and bottom calender rolls. Earlier designs used two tapered roller bearings with a spherical roller bearing. Recently, triple-ring bearings have been used to simplify the surrounding structure and installation.

Two spherical roller bearings (or spherical roller bearing and cylindrical roller bearing) are combined into one unit. Triple-ring bearings have three bearing rings (Inner, intermediate, and outer rings).

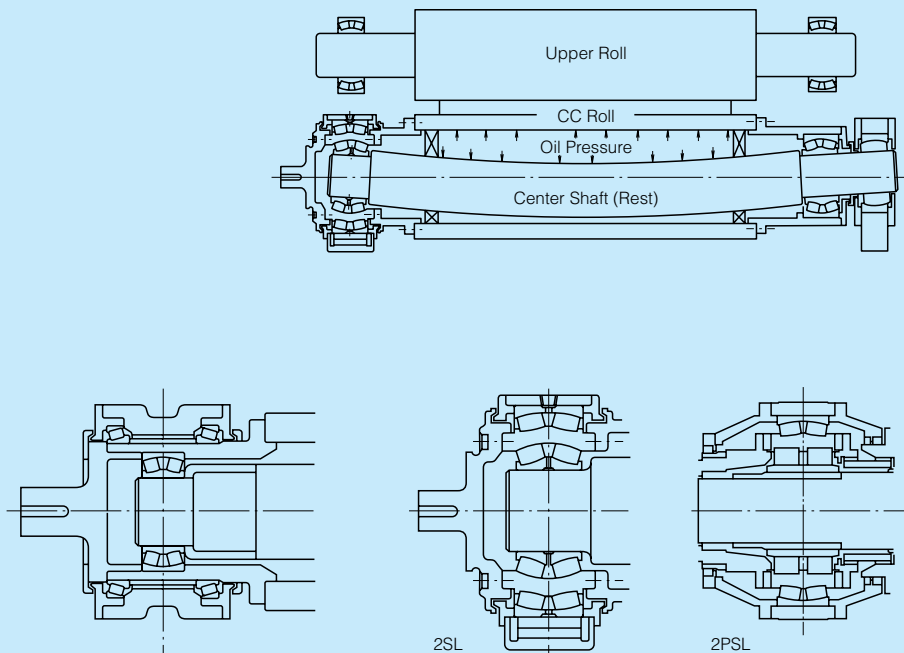

- Bearings have high load capacity (symmetrical rollers and no center rib).
- Inner bearing has no floating guide ring which further improves the load capacity.
- Ultra-clean carburizing grade bearing steel is used in critical components.
- High precision dimensional tolerances (suffix UPA).
- Specially designed inner ring and cage improve the inner bearing lubrication.
- Oil holes and grooves in the inner and outer rings are standard.

TRIPLE-RING BEARINGS

Bore Diameter 180 – 380 mm

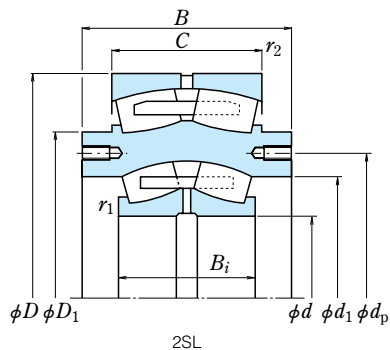

2SL

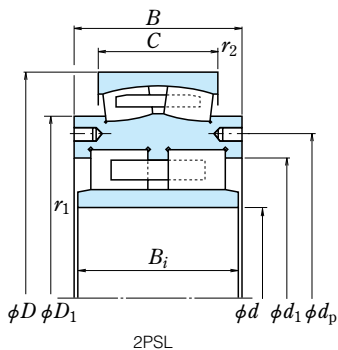

2PSL

Boundary Dimensions (mm)				Basic Load Ratings (kN) (kgf)								
<i>d</i>	<i>D</i>	<i>B</i>	<i>r</i> ₁ min.	<i>r</i> ₂ min.	Inner Brg.		Outer Brg.		Inner Brg.		Outer Brg.	
					<i>C</i> _r	<i>C</i> _{0r}	<i>C</i> _r	<i>C</i> _{0r}	<i>C</i> _r	<i>C</i> _{0r}	<i>C</i> _r	<i>C</i> _{0r}
180	480	215.9	4	4	1 490	2 500	2 440	5 050	151 000	255 000	249 000	515 000
200	520	241.3	4	5	1 820	3 050	2 920	6 050	186 000	315 000	298 000	615 000
220	600	279.4	4	5	2 220	3 750	3 600	7 600	226 000	385 000	370 000	775 000
240	600	225.0	4	4	2 700	4 600	2 840	6 500	275 000	470 000	290 000	665 000
	620	279.4	4	5	2 760	4 800	3 700	7 900	282 000	490 000	375 000	805 000
260	680	317.5	5	6	3 250	5 700	4 500	9 950	335 000	580 000	460 000	1 010 000
280	720	317.5	5	6	3 400	6 150	4 450	9 900	345 000	625 000	450 000	1 010 000
300	780	342.9	5	6	4 050	7 450	5 400	11 900	415 000	760 000	550 000	1 210 000
320	820	368.3	5	6	4 550	8 400	5 950	13 300	465 000	855 000	605 000	1 360 000
340	870	393.7	6	6	5 400	9 950	6 600	15 100	550 000	1 020 000	675 000	1 540 000
380	980	431.8	6	7.5	6 100	11 500	8 100	18 500	625 000	1 170 000	825 000	1 890 000

Bearing Numbers	Dimensions (mm)					Mass (kg) approx.
	B_i	C	d_1	d_p	D_1	
2SL180-2UPA	140	160	263.38	304.8	355.725	165
2SL200-2UPA	160	180	294	342.9	393.575	230
2SL220-2UPA	180	200	325.5	385.35	444.375	330
2PSL240-1UPA	205	160	373	438	488	285
2SL240-2UPA	200	200	361	412.75	469.775	410
2SL260-2UPA	218	218	383.54	457.2	520.575	490
2SL280-2UPA	218	218	409.3	482.6	545.975	525
2SL300-2UPA	243	250	444.5	527.05	606.325	735
2SL320-2UPA	258	258	477.3	552.45	634.9	840
2SL340-2UPA	280	272	506.141	609.6	676.175	1 050
2SL380-2UPA	300	308	561	647.7	738.1	1 460



CROSSED ROLLER BEARINGS FOR INDUSTRIAL ROBOTS

Bore Diameter 100 – 600mm B444

Design, Types, and Features

Crossed roller bearings are thin-cross section bearings consisting of one inner ring, a two-part outer ring, cylindrical rollers, and separators. The rollers are alternately oriented at right angles to each other and kept apart by separators.

One bearing can sustain both radial and axial loads and also strong moments. Since the load capacity is high and they are both light and compact, they are commonly used in the rotating joints of robots.

Preloading the bearings increases rigidity and improves positioning accuracy. Therefore, they are suitable for the support bearings of indexing mechanisms, rotary tables, etc. that are generally required to have high rigidity.

Sealed crossed roller bearings are prelubricated with lithium grease and can be used without maintenance.

Since the internal clearances in **NSK** crossed roller bearings are factory adjusted, they can be installed directly without trouble some shim adjustment. Simple mounting of bearings is possible since the outer ring parts are inseparable.

An example of the composition of bearing numbers is shown below:

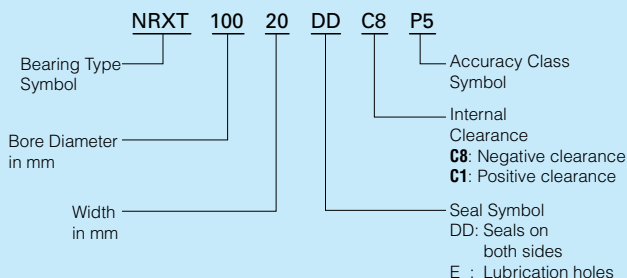

Recommended Fits and Internal Clearances

Table 1 Recommended Fits

Internal Clearance	Operating Conditions		Shaft	Housing
C8	Rotating Inner Ring	Normal Loads	h5 (Target Interference) 0 to 5µm	H6 (Target Clearance) 0 to 10µm
		Shock or Vibration		
	Rotating Outer Ring	Normal Loads	g5 (Target Clearance) 0 to 10µm	JS6 or J6 (Target Interference) 0 to 5µm
		Shock or Vibration		
C1	Rotating Inner Ring	Normal Loads	js5 or j5	H6
		Shock or Vibration	k5	JS6 or J6
	Rotating Outer Ring	Normal Loads	g6	JS6 or J6
		Shock or Vibration	h5	k6

Remarks If the preload is high, the fits in parentheses () are recommended.

Table 2 Internal Clearances

Units : µm

Bore diameter <i>d</i> (mm)		Internal Clearances			
		C8 ⁽¹⁾		C1	
over	incl	min.	max.	min.	max.
100	120	-15	0	10	30
120	140	-15	0	10	35
140	160	-15	0	10	35
160	180	-15	0	10	40
180	200	-15	0	15	45
200	225	-20	0	15	50
225	250	-20	0	15	50
250	280	-20	0	20	55
280	315	-20	0	20	60
315	355	-25	0	20	65
355	400	-25	0	25	75
400	450	-30	0	25	85
450	500	-30	0	25	95
500	560	-30	0	30	105
560	630	-30	0	30	115

Note ⁽¹⁾ Bearings with C8 (negative) clearances are produced with tolerances of Class P5 or better.

CROSSED-ROLLER BEARINGS

Bore Diameter 100 – 600 mm

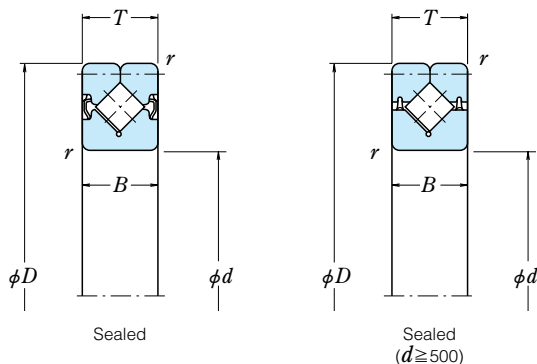

Boundary Dimensions (mm)				Basic Load Ratings				Bearing
d	D	$B \cdot T$	r min.	(kN)		(kgf)		
				C_r	C_{0r}	C_r	C_{0r}	Sealed
100	150	20	1	33.0	52.5	3 350	5 350	NRXT10020DD NRXT11020DD
110	160	20	1	35.0	59.0	3 600	6 000	
120	170	20	1.1	36.0	62.0	3 650	6 350	NRXT12020DD NRXT12025DD
	180	25	1.1	70.0	110	7 150	11 200	
130	190	25	1.1	72.5	118	7 400	12 000	NRXT13025DD NRXT14025DD
	200	25	1.1	75.0	125	7 650	12 800	
150	210	25	1.1	77.0	133	7 850	13 600	NRXT15025DD NRXT15030DD
	230	30	1.1	119	192	12 200	19 600	
200	260	25	1.5	88.0	172	9 000	17 500	NRXT20025DD NRXT20030DD
	280	30	1.5	136	247	13 800	25 200	
250	310	25	2	98.0	211	10 000	21 500	NRXT25025DD NRXT25030DD
	330	30	2	150	300	15 300	30 500	
300	360	25	2.1	107	250	10 900	25 500	NRXT30025DD NRXT30035DD NRXT30040DD
	395	35	2.1	194	405	19 700	41 500	
	405	40	2.1	199	425	20 300	43 000	
400	480	35	2.1	188	465	19 200	47 500	NRXT40035DD NRXT40040DD
	510	40	2.1	226	545	23 100	56 000	
500	600	40	2.1	239	625	24 400	64 000	NRXT50040DD NRXT50050DD
	625	50	3	325	810	33 000	82 500	
600	700	40	3	261	745	26 600	75 500	NRXT60040DD

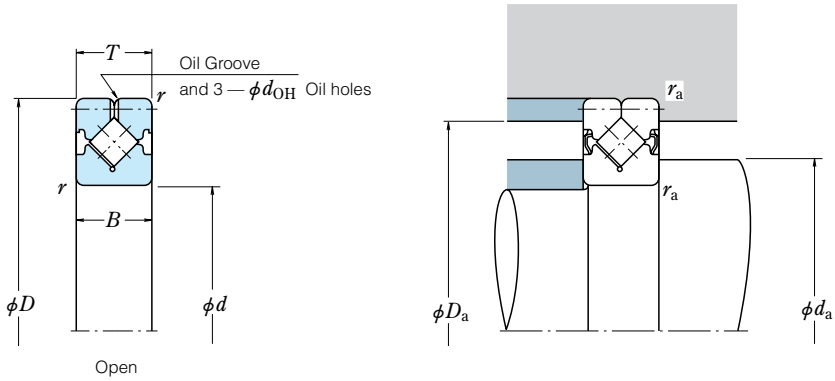

Numbers	Oil Holes (mm)	Abutment and Fillet Dimensions (mm)					Mass (kg)
		d_a		D_a		r_a	
Open	d_{OH}	min.	max.	min.	max.	max.	approx.
NRXT10020E	2.5	117	119	131	133	1	1.37
NRXT11020E	2.5	127	129	141	143	1	1.49
NRXT12020E	2.5	137	139	151	153	1	1.6
NRXT12025E	2.5	140	144	156	160	1	2.47
NRXT13025E	2.5	150	154	166	170	1	2.63
NRXT14025E	2.5	160	164	176	180	1	2.8
NRXT15025E	2.5	170	174	186	190	1	2.96
NRXT15030E	3	176	184	196	204	1	5.55
NRXT20025E	2.5	219	223	237	241	1.5	3.75
NRXT20030E	3	225	233	247	255	1.5	6.3
NRXT25025E	2.5	269	273	287	291	2	4.55
NRXT25030E	3	275	283	297	305	2	7.65
NRXT30025E	2.5	319	323	337	341	2	5.3
NRXT30035E	3	329	334	354	361	2	12.6
NRXT30040E	4	336	342	362	369	2	16.5
NRXT40035E	3	426	430	450	456	2	13.4
NRXT40040E	4	439	444	464	471	2	22.5
NRXT50040E	4	533	547	553	567	2	24.4
NRXT50050E	5	540	557	563	580	2.5	39.5
NRXT60040E	4	633	647	653	667	2.5	28.9

CONTENTS

SPECIAL NSK BEARINGS AND RELATED EQUIPMENT

	Pages
Ladder Bearings for Convertors	C 2
Super-Large Double-Split Bearings for Convertor Trunnions	C 4
Double-Split Bearing Units for Segmented Drive Rolls in Continuous Casters	C 5
Sealed-Clean Bearings for Guide Rolls and Pinch Rolls in Continuous Casters	C 6
Sealed-Clean Bearings for Chain Conveyors	C 8
Sealed-Clean Bearings for Sintering Equipment	C 9
Roll Units for Tension Levelers	C10
Bearing Heaters	C12
Bearing Monitors	C13

APPLICATION DRAWINGS

	Pages
Eccentric Shaft, Vibrating Screen	C14
Adjusting Screw Thrust Block, Hot Strip Rollings Mill	C15
Table Roller, Hot Strip Rolling Mill	C16
Work Roll Chock Assembly, Steel Strip Rolling Mill	C17
Backup Roll Chock Assembly, Cold Strip Rolling Mill	C18
Work Roll Chock Assembly, Cold Strip Rolling Mill	C19
Horizontal Roll Chock Assembly, Large-Size Universal Rolling Mill	C20
Finishing Roll Chock Assembly, Wire Rolling Mill	C21
Final Drive, Bulldozer	C22
Axle Assembly, Dump Truck	C23
Bent Axis Type Axial Piston Pump	C24
Tapered Roller Bearing, Heavy Dusty Extruder	C25
Axlebox Bearing, New Commuter Train	C26
Traction Motor, Bullet Train (SHINKANSEN)	C27
Flywheel and Clutch Assembly, Large-Size Press	C28
Suction Roll, Paper Making Machine	C29
Dryer Roll, Paper Making Machine (Free End)	C30
Press Roll, Paper Making Machine (Free End)	C31

APPENDICES

Appendix Table 1 Conversion from SI (International Units) System	C32
Appendix Table 2 N-kgf Force Conversion Table	C34
Appendix Table 3 kg-lb Mass Conversion Table	C35
Appendix Table 4 °C-°F Temperature Conversion Table	C36
Appendix Table 5 Viscosity Conversion Table	C37
Appendix Table 6 inch-mm Dimension Conversion Table	C38
Appendix Table 7 Hardness Conversion Table	C40
Appendix Table 8 Physical and Mechanical Properties of Materials	C41
Appendix Table 9 Tolerances for Shaft Diameters	C42
Appendix Table 10 Tolerances for Housing Bore Diameters	C44
Appendix Table 11 Values of Standard Tolerance Grades IT	C46
Appendix Table 12 Speed Factor f_n	C48
Appendix Table 13 Fatigue Life Factor f_n and Fatigue Life $L \cdot L_n$	C49
Index of Inch Design Tapered Roller Bearings	C50

Ladder Bearings for Convertors

Features

TRL ladder bearings are linear motion bearings consisting of a single or double row of cylindrical rollers between flat raceways. They are used to relieve the axial displacement of the trunnion bearings and housings caused by heat.

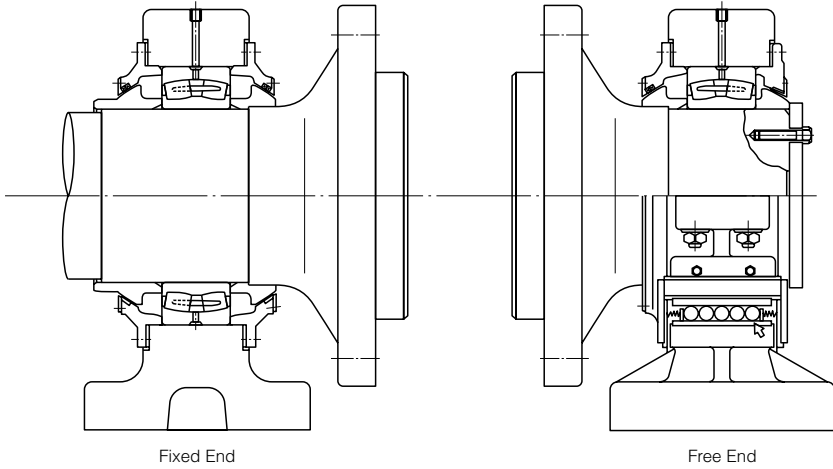

Structure of Converter Trunnion Necks

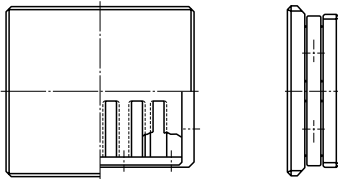

Figure 1

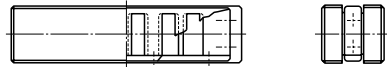

Figure 2

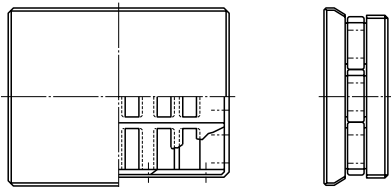

Figure 3

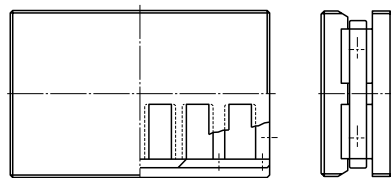
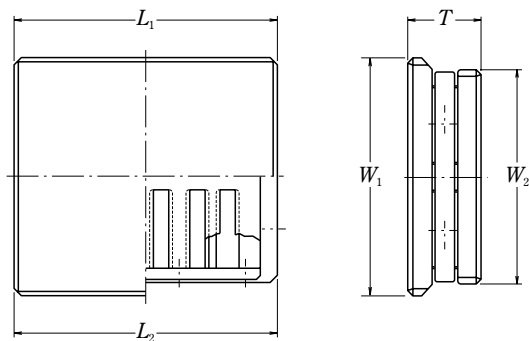

Figure 4



Bearing Numbers	Dimensions (mm)					Figure	Basic Load Ratings (kN) C_{0a}
	T	W_1	W_2	L_1	L_2		
60TRL02B	60	200	180	220	220	1	3 500
60TRL08	60	240	240	240	240	1	4 800
60TRL09	60	230	230	265	265	1	4 800
60TRL12	60	230	230	230	230	1	5 600
65TRL01	65	215	200	220	220	1	4 400
80TRL02	80	300	300	400	400	1	9 550
90TRL03	90	250	230	300	300	3	6 600
90TRL04	90	265	245	300	300	3	7 100
90TRL05	90	250	230	300	300	1	6 950
90TRL06	90	84	84	270	270	2	2 360
90TRL08	90	112	112	280	280	2	3 450
95TRL02	95	280	280	440	440	4	11 900
96TRL02	96	300	300	310	310	4	9 800
110TRL02	110	350	350	490	490	4	17 100
110TRL03	110	350	350	500	500	4	17 100
160TRL01	160	400	400	550	550	4	25 700

Super-Large Double-Split Bearings for Converter Trunnions

Features

- double-split bearing for the driven converter trunnion enables changing the bearing without removing the bull gear.
- Large reduction in bearing replacement time and expense
- Substitution is possible within the space required for standard bearings.

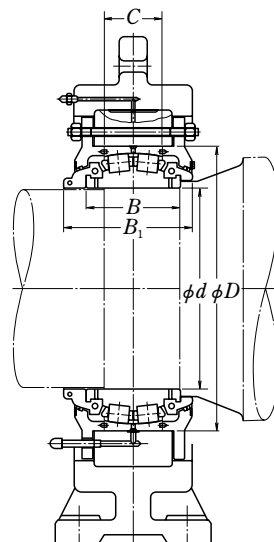
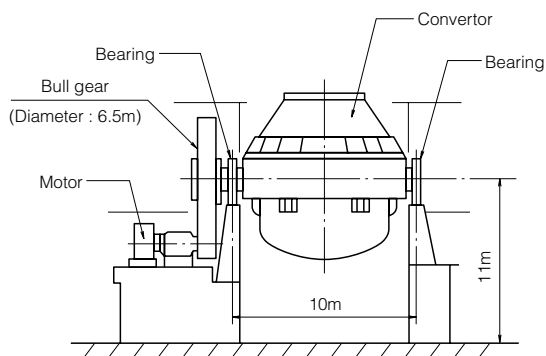

Bearing Numbers	Boundary Dimensions (mm)					Basic Load Ratings (kN)	
	d	D	C	B	B_1	C_r	C_{0r}
950SLPT1451	950	1 400	300	520	600	12 300	27 900
1200SLPT1752	1 200	1 700	410	660	730	17 300	43 500
1400SLPT1951	1 400	1 900	530	880	880	22 800	65 000

Double-Split Bearing Units for Segmented Drive Rolls in Continuous Casters

(Full-Complement Double-Split Cylindrical Roller Bearings)

Features

- Integrated full-complement double-split cylindrical roller bearings with high load capacity within a limited space
- Three seals for maximum protection; special seal, self-lubricating seal, and labyrinth seal
- Smooth self-aligning capability prevents edge loads on rollers
- Direct inner ring coupling for high precision and easy handling
- Sufficient space for water jacket enables effective cooling.

Segmented Drive Roll

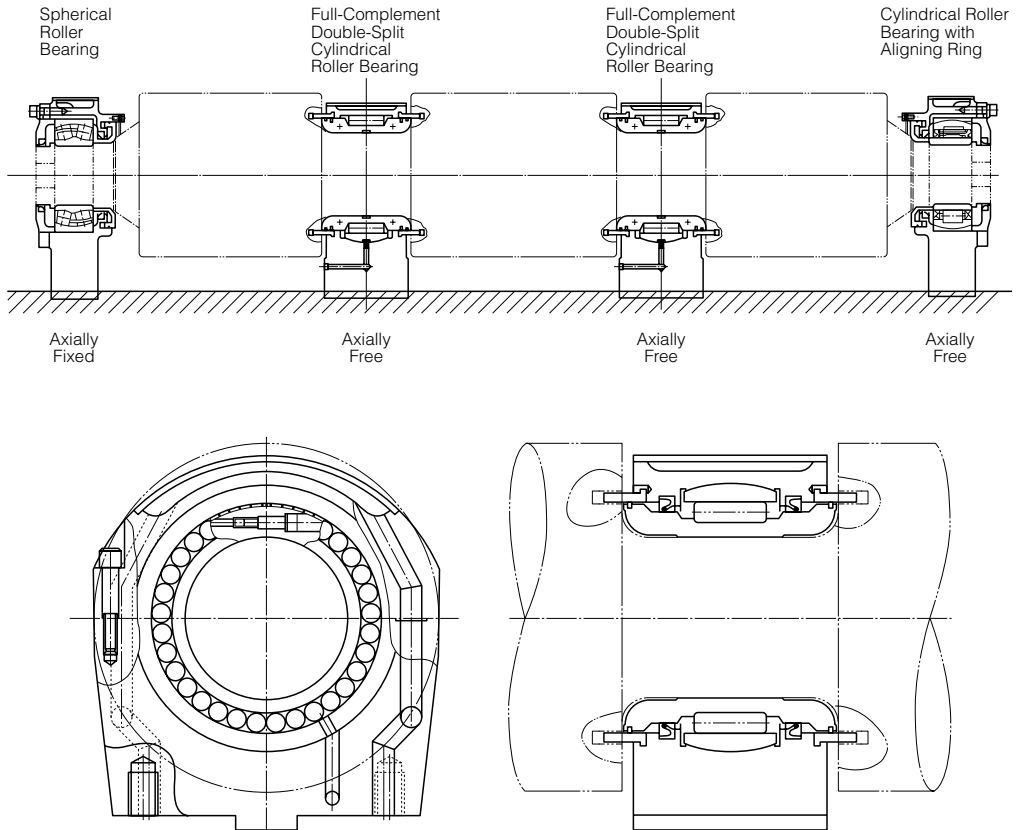

Sealed-Clean Bearings for Guide Rolls and Pinch Rolls in Continuous Casters

Features

- Special design of flexible seals assures excellent sealing and smooth axial movement of the seal lips to allow roll bending and thermal elongation.
- Special grease has been developed to lubricate continuous caster bearings. Since its heat resistance, pressure resistance, and rust preventive capability are excellent, bearings operate for a long time without maintenance.

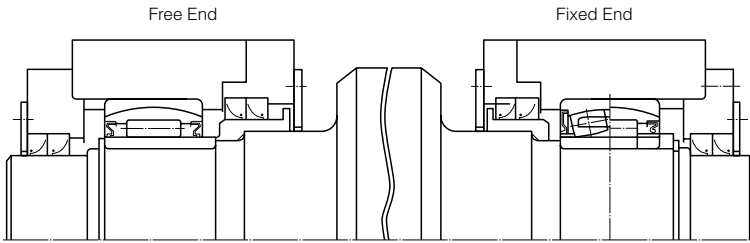

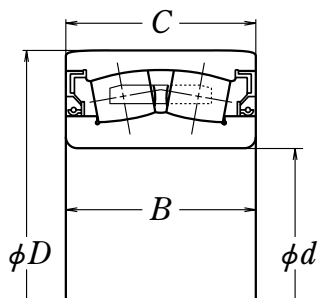

SLE Type

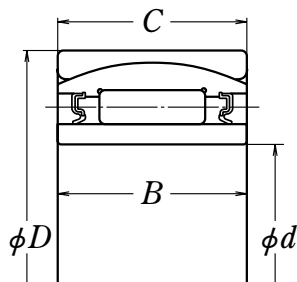

RUBE Type

	Bearing Numbers	Boundary Dimensions (mm)				Basic Load Ratings (kN)	
		<i>d</i>	<i>D</i>	<i>B</i>	<i>C</i>	<i>C_r</i>	<i>C_{0r}</i>
SLE Type	110SLE414	110	180	69	69	385	630
	110SLE224	110	200	53	53	310	425
	120SLE414	120	200	80	80	510	810
	140SLE304	140	210	53	53	315	490
	160SLE404	160	240	80	80	605	1 040
	180SLE404	180	280	100	100	880	1 590
	180SLE413	180	300	118	118	1 050	1 760
	190SLE414	190	320	128	128	1 320	2 210
	200SLE414	200	340	140	140	1 550	2 670
RUBE Type	110RUBE1702PV	110	170	70	60	280	665
	120RUBE2101PV	120	215	80	76	470	820
	130RUBE2001PV	130	200	77	69	405	935
	130RUBE41E1PV	130	210	80	80	450	1 010
	140RUBE2101PV	140	210	77	69	385	885
	150RUBE2701PV	150	270	104	96	785	1 520
	150RUBE40PV	150	225	75	75	465	1 160
	150RUBE41PV	150	250	100	100	595	1 290
	160RUBE40APV	160	240	80	80	485	1 180
	170RUBE3102PV	170	310	118	110	990	1 910
	180RUBE2801PV	180	280	107	100	785	1 870
	180RUBE40APV	180	280	100	100	785	1 870

Sealed-Clean Bearings for Chain Conveyors

Features

- More effective sealing with side contact seals
- Improved shock resistance by adopting case-hardened steel for the outer rings
- Long periods of operation without replenishing the grease are possible because of the high quality grease supplied.

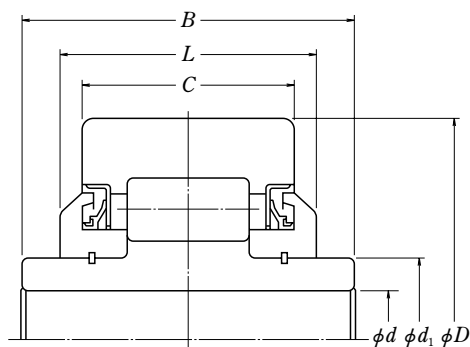
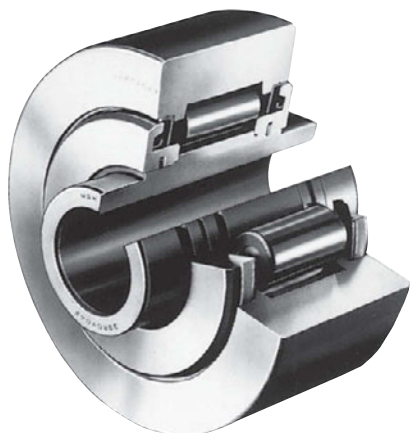

Bearing Numbers	Boundary Dimensions (mm)					
	d	d_1	D	C	B	L
28RCV13	28.2	39.95	125	55	85.4	60
30RCV17	30.3	50.03	135	65	103	78
30RCV21	30.2	45.0	135	55	94	62
30RCV25	30.3	50.03	135	65	105	70
38RCV07	38.25	55.75	150	70	114.2	83.2
38RCV13	38.7	56.0	150	70	114.2	76
41RCV07	41.75	64.16	175	80	125	85

Sealed-Clean Bearings for Sintering Equipment

Features

Pallet Wheel Bearings

Internal oil seals on both sides of the bearing and an external seal with a unique lip design on the inboard side prevent the entry of foreign matter and assure maintenance-free operation and long life.

Bearings for Inboard Rollers

Existing journal (sliding) bearings are being replaced by sealed cylindrical roller bearings because they require less maintenance and reduce cost.

Sealed-Clean Double-Row
Tapered Roller Bearings
(AR Type) for Pallet Wheels

Sealed-Clean Double-Row
Cylindrical Roller Bearings
(2J Type) for Inboard Rollers

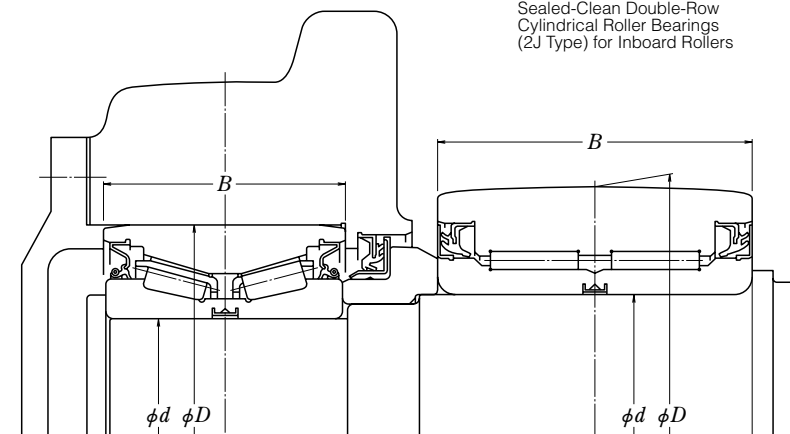

Application	Bearing Numbers	Boundary Dimensions (mm)			Basic Load Ratings			
		<i>d</i>	<i>D</i>	<i>B</i>	(kN)		(kgf)	
					<i>C_r</i>	<i>C_{0r}</i>	<i>C_r</i>	<i>C_{0r}</i>
Pallet Wheels	AR100-34	100	180	100	350	675	35 500	69 000
	AR110-27	110	200	100	415	805	42 000	82 000
Inboard Rollers	2J120-11	120	210	132	425	1 390	49 500	183 000
	2J160Z-4	160.11	250	130	485	1 800	43 500	142 000

Roll Units for Tension Levelers

Features

Exclusive Roll Units Continuous Galvanizing Lines and Continuous Pickling Lines

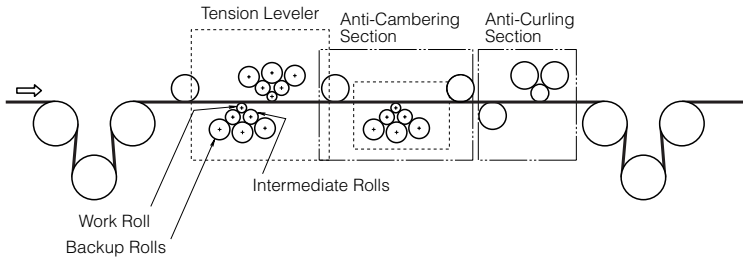

Line speeds: 0 to 1 500m/min

Work Roll and Intermediate Roll Units

Rolls units with integrated thrust blocks at both ends offer high precision and high speed capability.

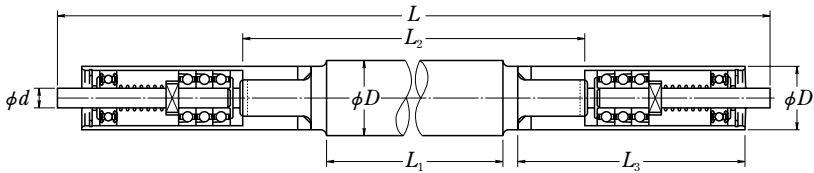

Unit bearing Numbers	Boundary Dimensions (mm)						
	D	d	L	L_1	L_2	D_1	L_3
10UMB09+WX1812-01	18	10	1 391	1 200	1 258	32	70.5
10UMB09+WX2012-01	20	10	1 391	1 200	1 258	32	70.5
12UMB15+WX3015-01	30	10	1 748	1 500	1 580	28	85
15UMB01B+IX5015-01	50	15	1 730	1 500	1 580	38	85

Backup Roll Units

High-accuracy, low-torque backup roll units with highly effective seals

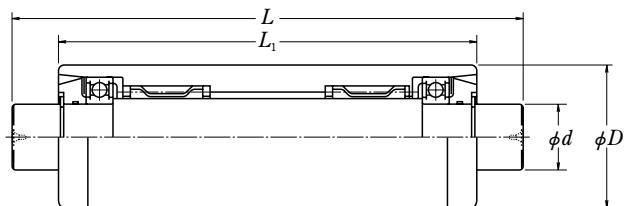

Figure 1

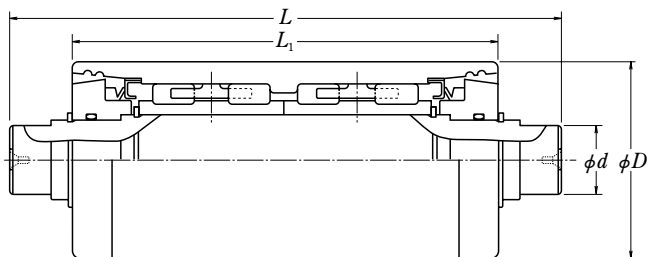
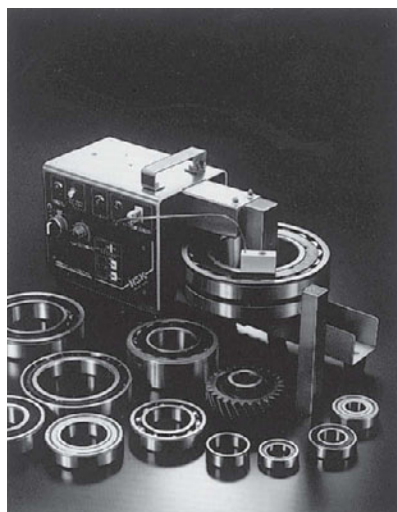

Figure 2

Unit bearing Numbers	Boundary Dimensions (mm)				Basic Load Ratings (kN)		Figure
	<i>D</i>	<i>d</i>	<i>L</i> ₁	<i>L</i> ₂	<i>C</i> _{rH}	<i>C</i> _{0rH}	
25UMB10	50	22	193	152	66.5	99	1
27UMB01	50	22	203	162	79	126	1
27UMB03	50	22	191	150	79	126	1
35UMB08	63	22	193	152	67	139	1
35UMB25	63	22	203	162	87.5	165	1
35UMB27	63	22	191	150	87.5	165	1
34UMB07B	75	26	208	160	131	195	2

Bearing Heaters



Features

- **Fast, Uniform Heating**
Induction heating reduces bearing mounting time and cost.
- **No Oil Tanks Required**
Since no oil is necessary, there can be no spills or other mess and bearings remain clean.
- **Safe Operation**
Since there are no flames, there is no fire hazard, and an internal circuit breaker guards against an electrical short.
- **Compact and Light**
Most NSK Bearing Heaters are light enough to be carried easily and used anywhere.
- **Automatic Temperature Control**
A thermostatic control can be set at any temperature up to 200°C. When the desired level is reached, a buzzer sounds and constant temperature is maintained.
- **Automatic Demagnetizing**
When the heating is finished, the bearing is quickly and automatically demagnetized.
- **Bearing Rest**
A convenient rest supports the bearing and allows it to be easily positioned.
- **Versatility**
Besides bearings, other metallic rings such as inner ring spacers can also be heated for shrink fitting or for other purposes.

Composition of Bearing Heater Model Numbers

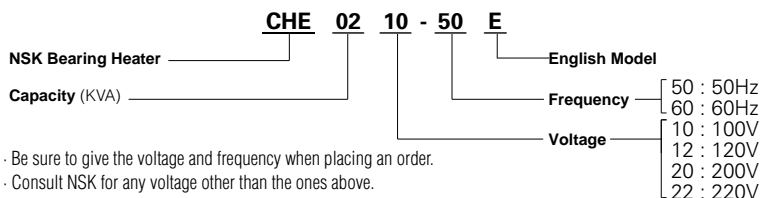

Standard Specifications

Model No.		CHE0210	CHE0220	CHE0420	CHE0720	CHE1220	CHE2020
Power voltage	(V)	100	200	200	200	200	200
Capacity	(kVA)	2	2	4	7	12	20
No. of phases		Single			Single		
Frequency	(Hz)	50 or 60			50 or 60		
External dimensions (mm)	Height	236			504	1115	1115
	Width	158			500	600	600
	Length	372		472	710	1280	1365
Mass of main body	(kg)	16.0	16.5	18.5	75	242	278
Applicable bearing sizes (mm)	A	Max 110			Max 175	Max 310	Max 355
	B	Max 80			Max 200	Max 300	Max 400
	d	Min φ 20			Min φ 35	Min φ 50	Min φ 50

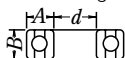

Bearing Monitors

NSK Bearing Monitors measure and process the vibrational acceleration of bearings to give early warning of trouble and allow rationalization of maintenance.

Features

- Instruments detect various kinds of abnormalities.
- Readings are in basic **g** units ($1\text{g}=9.8\text{m/sec}^2$).
- Various output circuits allow further analysis.
- Model NB-4 is a pocket-size type utilizing microelectronics. Besides checking bearing, it is convenient for general vibration measurements.



NB-4

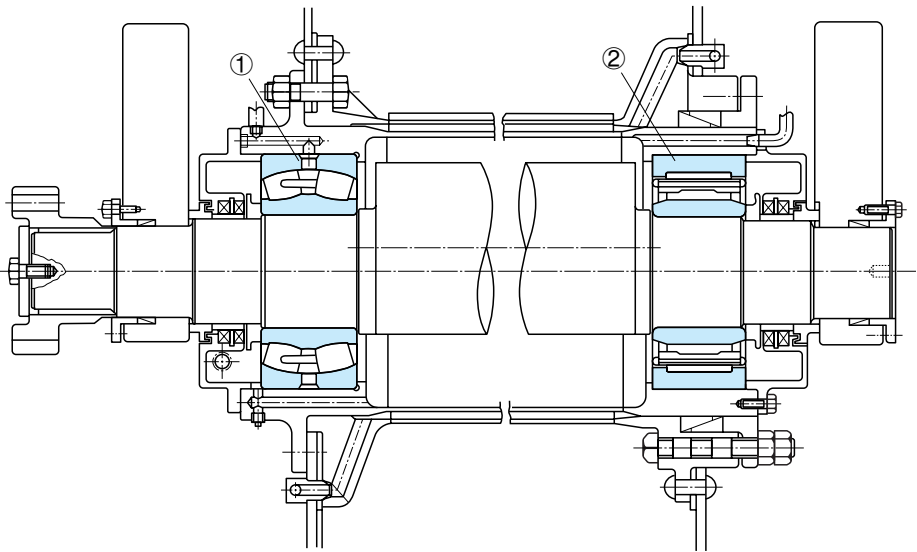

Figure 1 Eccentric shaft, Vibrating Screen

Bearing No.		① 23340CAME4-VS	② NU3340A-VS
Dimensions (Bore × O.D. × Width)		φ 200× φ 420×165 mm	φ 200× φ 420×165 mm
Load	Radical	250 kN	250 kN
	Axial	—	—
Speed		750 min ⁻¹	
Fits		Shaft k6	
		Housing N6	
Lubrication		Circulating Lubrication	

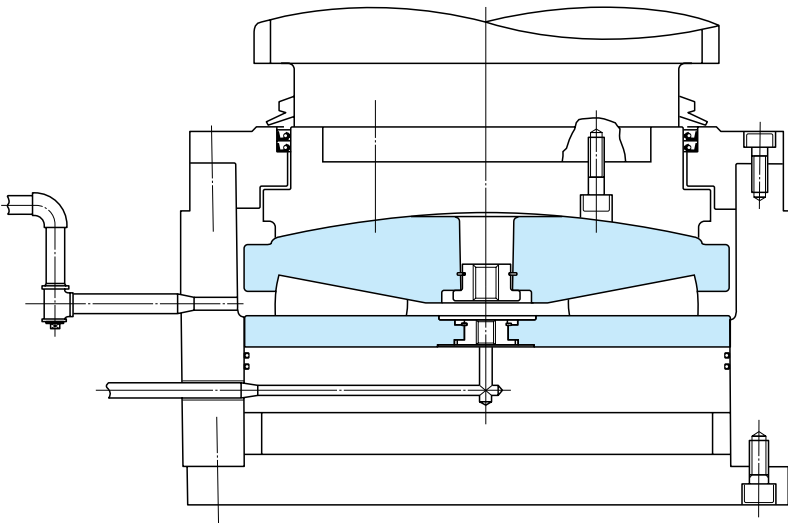

Figure 2 Adjusting Screw Thrust Block, Hot Strip Rolling Mill

Bearing No.		581TFX01
Dimensions (O.D. × Width)		φ 581.025×192.99 mm
Load	Radical	—
	Axial	15 700 kN
Speed		3 to 4 min ⁻¹
Fits		Shaft : —
		Housing : —
Lubrication		Oil Bath Lubrication

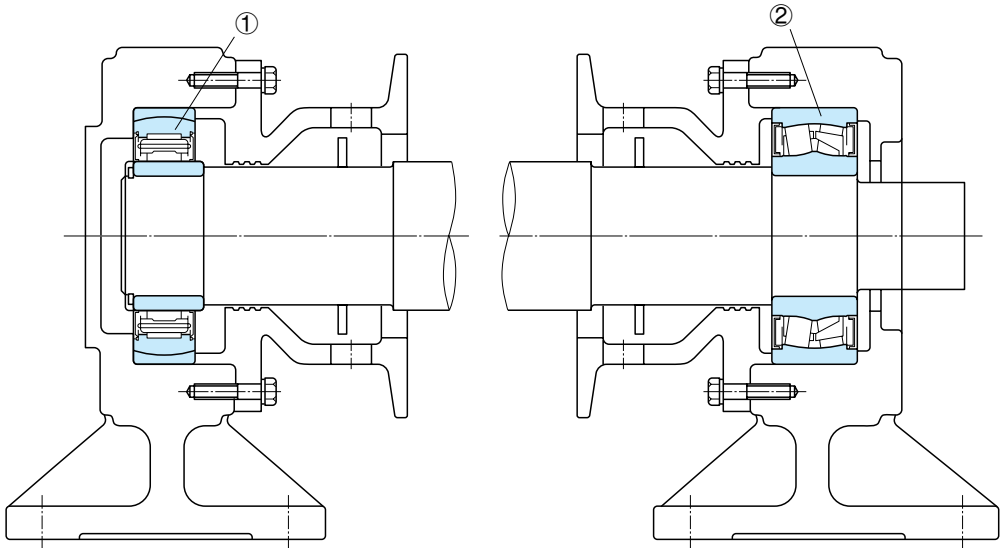

Figure 3 Table Roller, Hot Strip Rolling Mill

Bearing No.		① 90RUBE1903	② 90SLE231LL
Dimensions (Bore × O.D. × Width)		φ 90 × φ 190 × 46 mm	φ 90 × φ 190 × 64 mm
Load	Radical	2.95 kN	2.95 kN
	Axial	—	—
Speed		Max 1650 min ⁻¹	
Fits		Shaft n6	Shaft n6
		Housing G7	Housing G7
Lubrication		Grease (Sealed-Clean)	

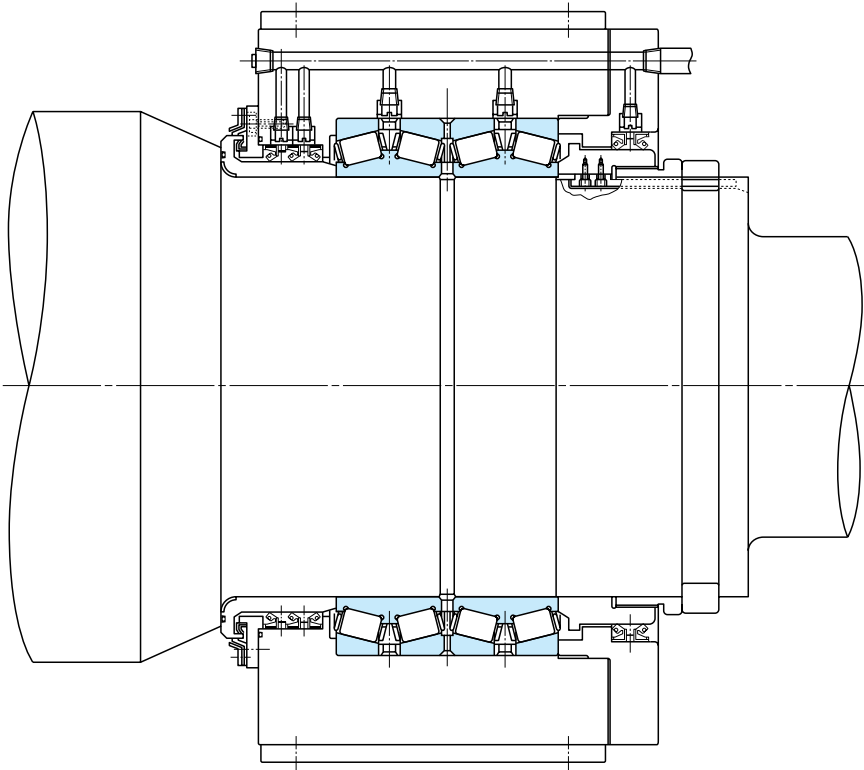

Figure 4 Work Roll Chock Assembly, Steel Strip Rolling Mill

Bearing No.		685KV8751g
Dimensions (Bore × O.D. × Width)		φ 685.800× φ 876.300×355.600/352.422 mm
Load	Radical	1810 kN
	Axial	1230 KN
Speed		80 min ⁻¹
Fits		Shaft -0.250 -0.325
		Housing $+0.225$ $+0.150$
Lubrication		Grease

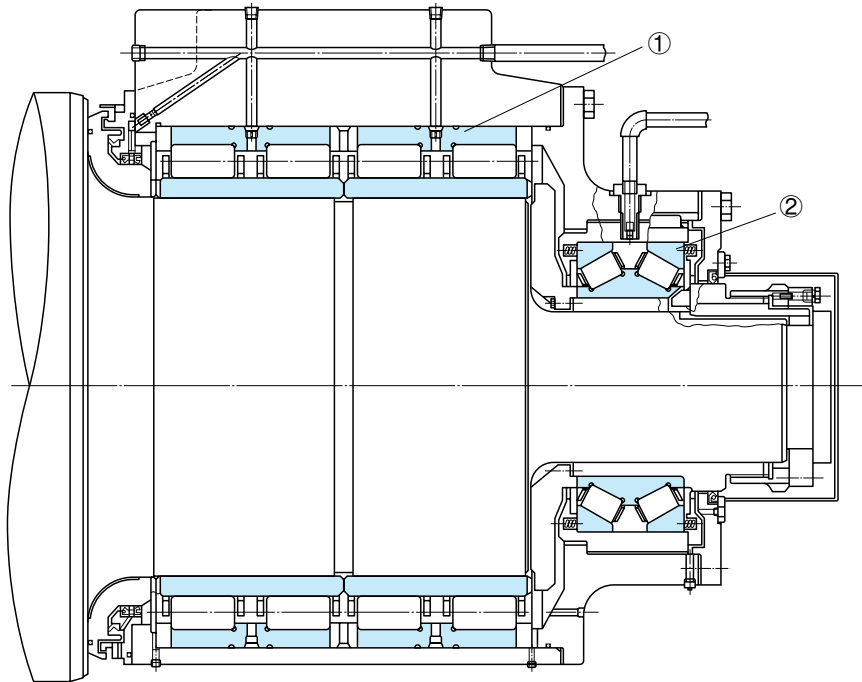

Figure 5 Back-Up Roll Chock Assembly, Cold Strip Rolling Mill

Bearing No.		① 920RV1211A	② 482KDH7351A
Dimensions (Bore × O.D. × Width)		φ 920× φ 1280×850 mm	φ 482.600× φ 733.425×200 mm
Load	Radical	7840 kN	—
	Axial	—	167 kN
Speed		314 min ⁻¹	
Fits		Shaft $\begin{smallmatrix} +0.480 \\ +0.390 \end{smallmatrix}$	Shaft : Loose
		Housing G7	Housing : Loose
Lubrication		Oil Mist Lubrication	

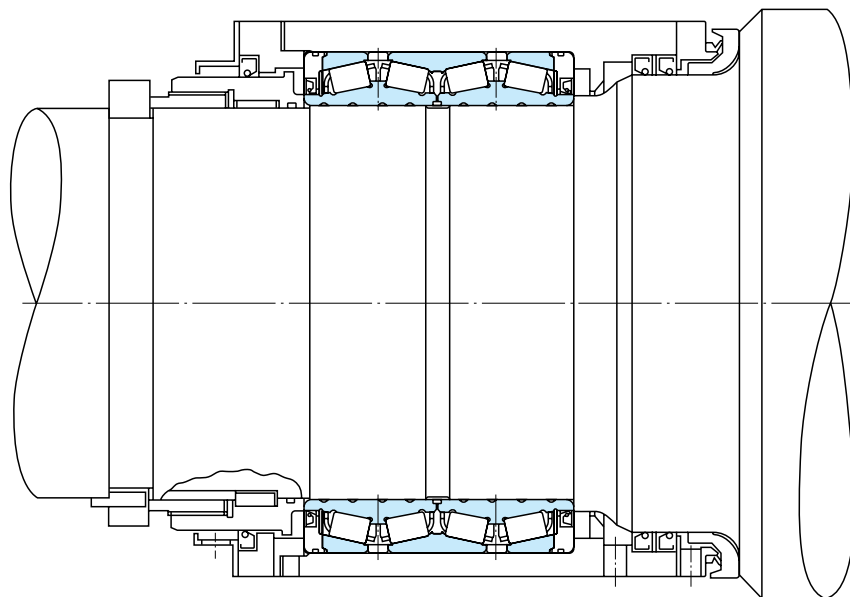

Figure 6 Work Roll Chock Assembly, Cold Strip Rolling Mill

Bearing No.		343KVE4557BEg
Dimensions (Bore x O.D. x Width)		ϕ 343.052 x ϕ 457.098 x 254.000 mm
Load	Radical	392 kN
	Axial	98 kN
Speed		Max 1050 min ⁻¹
Fits		Shaft $^{-0.200}$ $^{-0.250}$
		Housing $^{+0.150}$ $^{+0.100}$
Lubrication		Grease (Sealed-Clean)

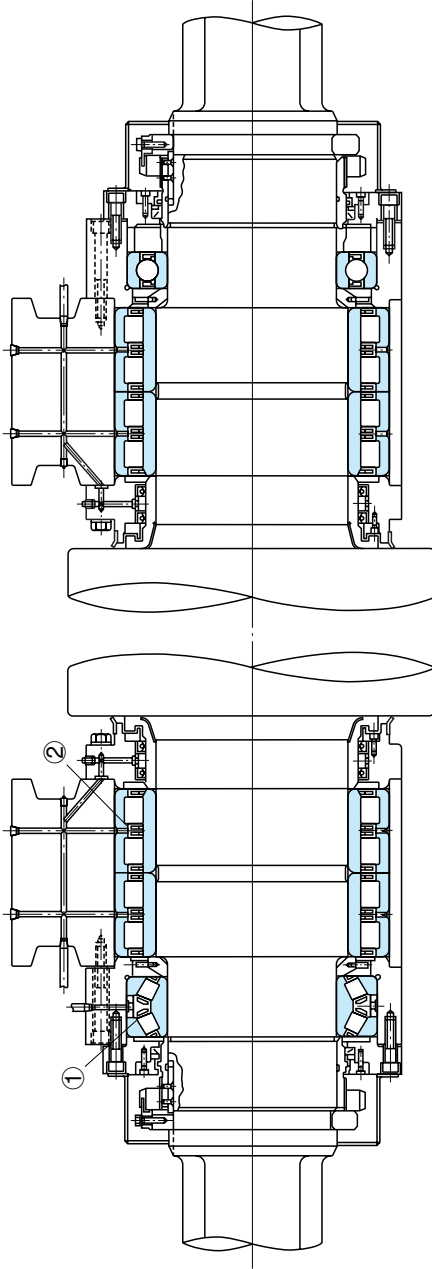

Figure 7 Horizontal Roll Chock Assembly, Large-Size Universal Rolling Mill

Bearing No.	① 305KDH5601+K	② 2J530-1gDR
Dimensions (Bore x O.D. x Width)	ϕ 305.069 x ϕ 560 x 2.00 mm	ϕ 530 x ϕ 730 x 640 mm
Load		
Radical	—	5880 kN
Axial	1180 kN	—
Speed		150 min ⁻¹
Fits		
Shaft : Loose	Shaft : Loose	Shaft : Loose
Housing : Loose	Housing : Loose	Housing G7
Lubrication		Grease

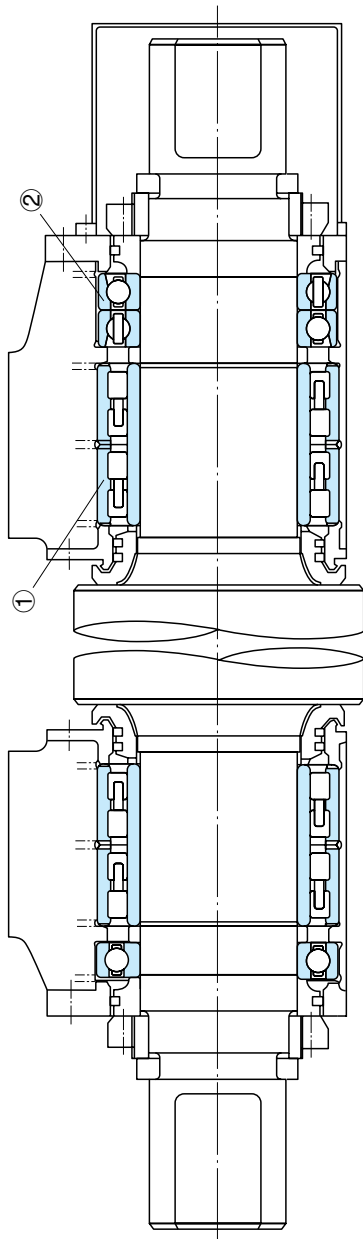

Figure 8 Finishing Roll Chock Assembly, Wire Rolling Mill

Bearing No.	① 150RV2302	② BA150-3DB
Dimensions (Bore x O.D. x Width)	ϕ 150x ϕ 230x156 mm	
Radical	49kN	ϕ 150x ϕ 230x70 mm
Load	—	—
Speed	—	9.8kN
Fits	Shaft p6	Shaft f6
	Housing G7	Housing Clearance 0.5
Lubrication	Grease	

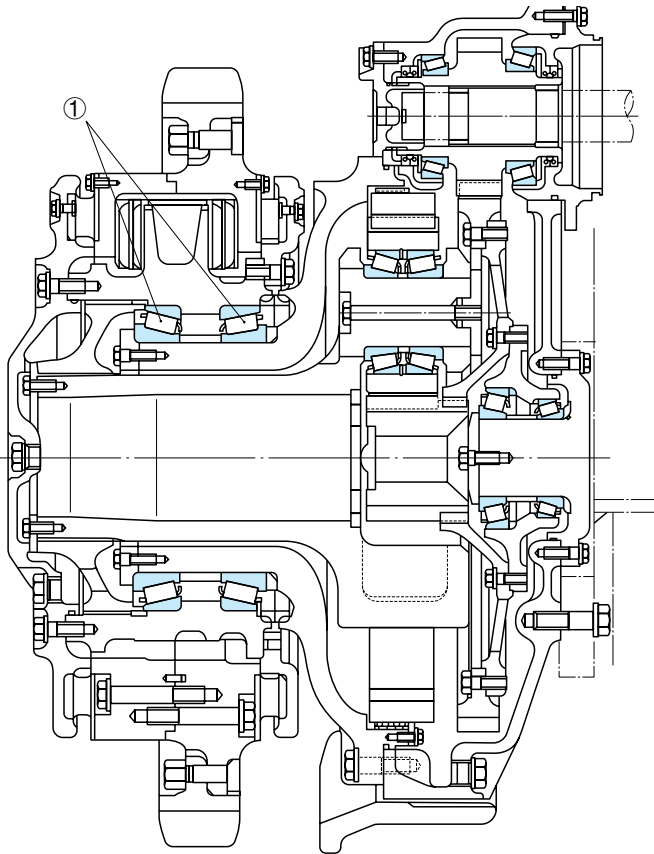

Figure 9 Final Drive, Bulldozer

Bearing No.		① LM361649/LM361610DB+LR
Dimensions (Bore × O.D. × Width)		φ 342.900× φ 450.850×66.675 (combined)mm
Load	Radical	—
	Axial	—
Speed		—
Fits		—
Lubrication		—

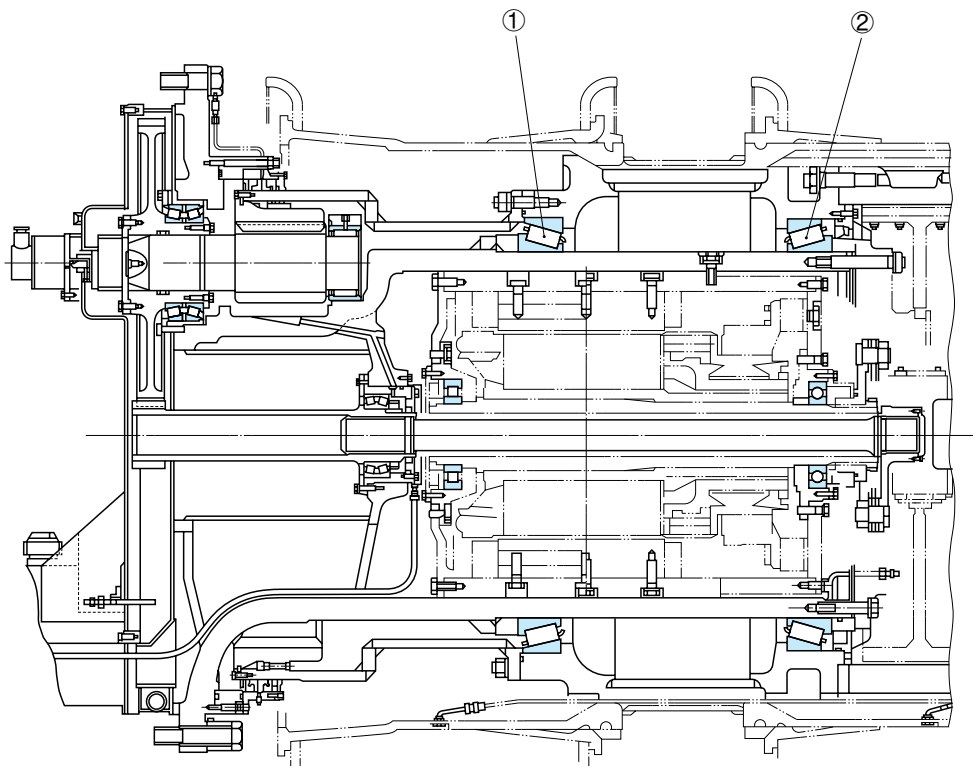

Figure 10 Axle Assembly, Dump Truck

Bearing No.		① R785-1	② R780-2
Dimensions (Bore × O.D. × Width)		$\phi 785 \times \phi 925 \times 95$ mm	$\phi 780 \times \phi 925 \times 95$ mm
Load	Radical	—	
	Axial	—	
Speed		Max 120 min ⁻¹	
Fits		Shaft : transition fit	
		Housing : interference fit	
Lubrication		Splash Lubrication	

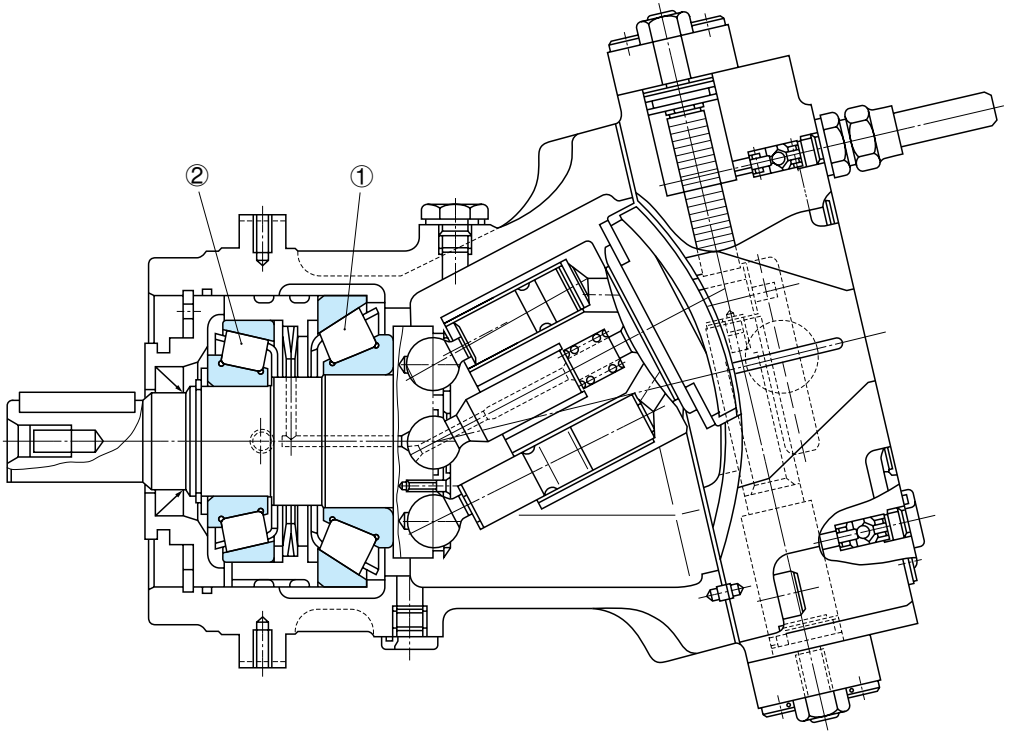

Figure 11 Bent Axis Type Axial Piston Pump

Bearing No.		① 30326D	② HR30317J
Dimensions (Bore × O.D. × Width)		φ 130×φ 280×63.75 mm	φ 85×φ 180×44.5 mm
Load	Radical	89.5 kN	37.8 kN
	Axial	137kN	—
Speed		1800 min ⁻¹	
Fits		Shaft p6 Housing K7	
Lubrication		Circulating Lubrication	

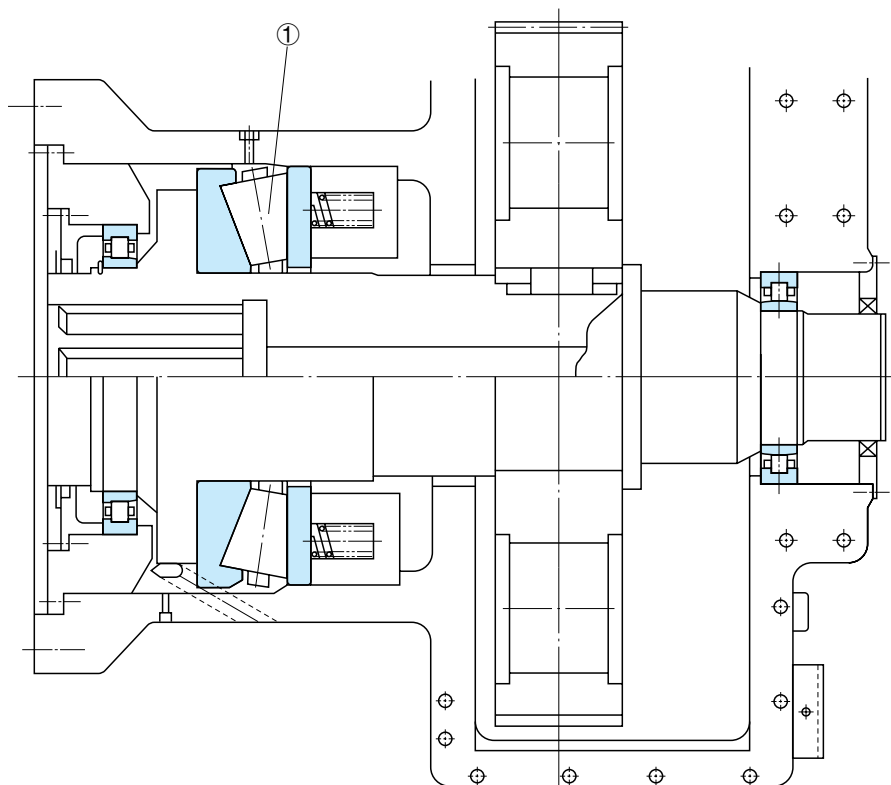

Figure 12 Tapered Roller Thrust Bearing in Heavy Duty Extruder

Bearing No.		① 431TTF8651
Dimensions (Bore x O.D. x Width)		ϕ 431.800 x ϕ 863.600 x 228.600 mm
Load	Radical	3920 kN
	Axial	—
Speed		150 min ⁻¹
Fits		Shaft $^0_{-0.051}$
		Housing $^{+0.152}_{+0.076}$
Lubrication		Circulating Lubrication

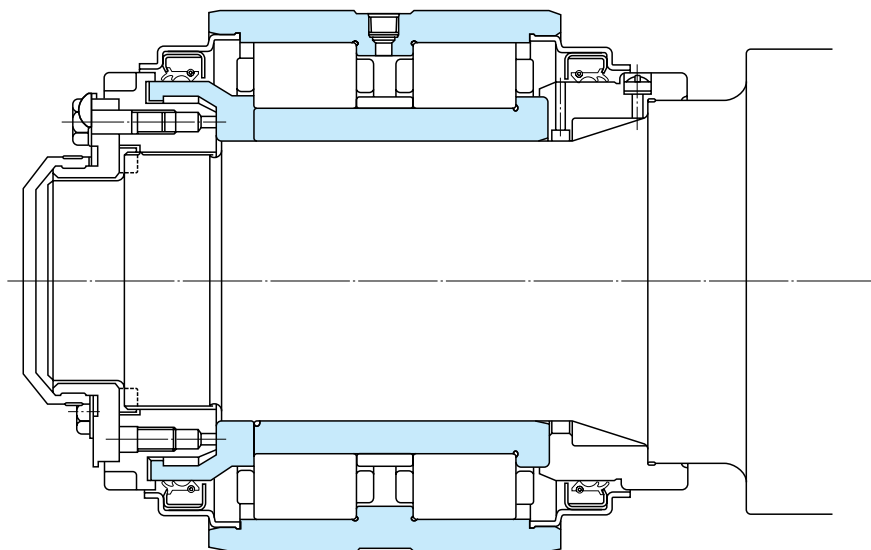

Figure 13 Axlebox Bearing, New Commuter Train

Bearing Numbers	Bore Dia.	Boundary Dimensions (mm)		
		Out-side Dia.	Outer Ring Width	Inner Ring Width
2M110-3	110	220	160	154
110JRF01	110	220	170	182
120JRF04	120	220	175	182
2M120-7	120	240	160	—
JC26	120	240	160	162
JC32	120	230	150	142
130JRF03	130	240	160	160
2M130-8	130	260	180	182
130JRF02	130	260	175	182

Bearing No.		JC32
Dimensions (Bore × O.D. × Width)		$\phi 120 \times \phi 230 \times 150$ mm
Load	Radical	Max 90 kN
	Axial	27kN
Speed		700 min^{-1}
Fits		Shaft n6
		Housing : —
Lubrication		Grease

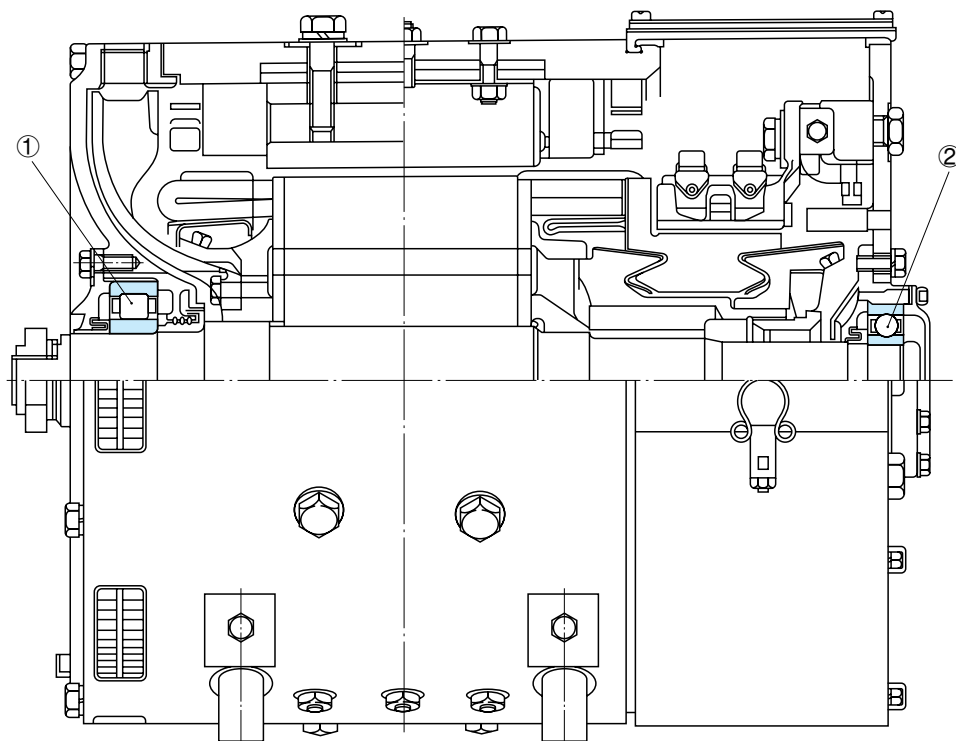

Figure 14 Traction Motor, Bullet Train (SHINKANSEN)

Bearing No.		① NU316MA3C4EP6	② 6312C4P6
Dimensions (Bore × O.D. × Width)		$\phi 80 \times \phi 170 \times 39$ mm	$\phi 60 \times \phi 130 \times 31$ mm
Load	Radical	4.2 kN	1.9 kN
	Axial	—	—
Speed		3700 min ⁻¹	
Fits	Shaft n6		Shaft m5
	Housing $\begin{smallmatrix} -0.004 \\ -0.021 \end{smallmatrix}$		Housing K6
Lubrication		Grease	

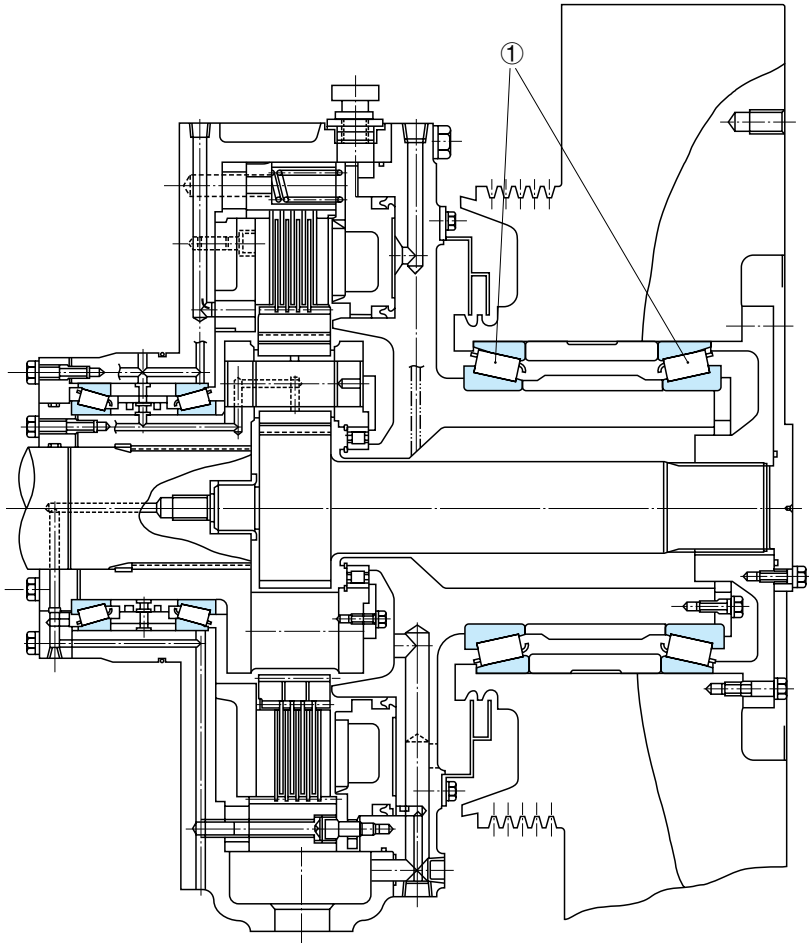

Figure 15 Flywheel and Clutch Assembly, Large-Size Press

Bearing No.		① 32960DB+KLR172
Dimensions (Bore × O.D. × Width)		$\phi 300 \times \phi 420 \times 76$ (combined)mm
Load	Radical	27.5 kN
	Axial	—
Speed		Max 900 min ⁻¹
Fits		Shaft h6
		Housing K6
Lubrication		Circulating Lubrication

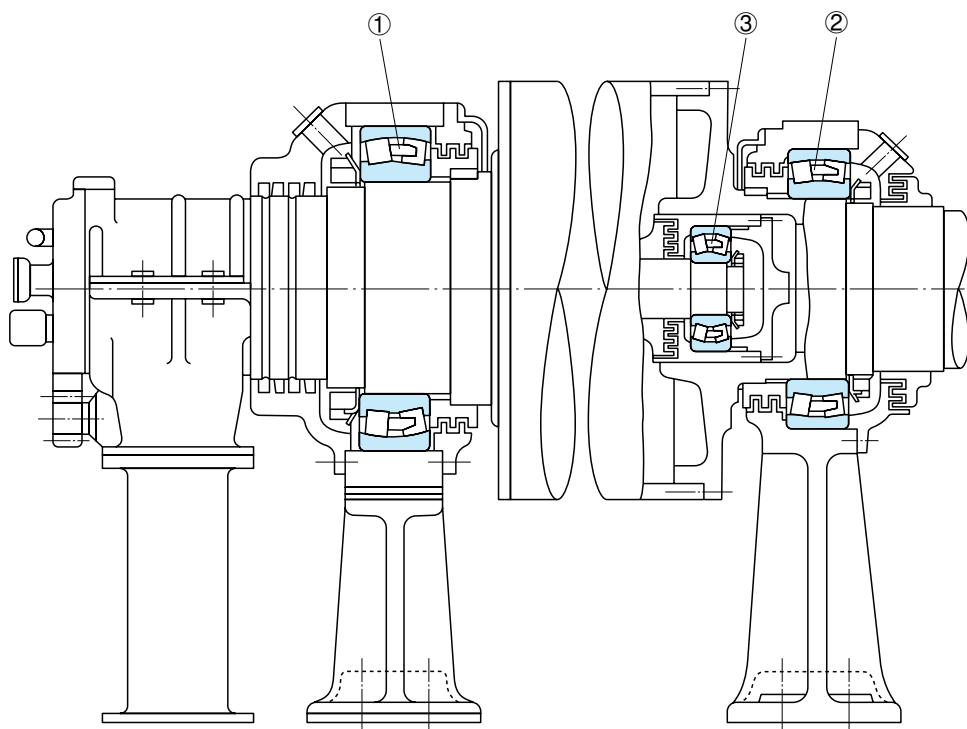

Figure 16 Suction Roll, Paper Making Machine

Bearing No.		① 230/600CAM E4	② 23184CAM E4	③ 22330CAM
Dimensions (Bore × O.D. × Width)		φ 600×φ 870×200 mm	φ 420×φ 700×280 mm	φ 150×φ 320×108 mm
Load	Radical	108 kN	83 kN	44 kN
	Axial	—	—	—
Speed		328 min ⁻¹		
Fits		Shaft : Tight		Shaft : Loose
		Housing : Loose		Housing : Tight
Lubrication		Circulating Lubrication		

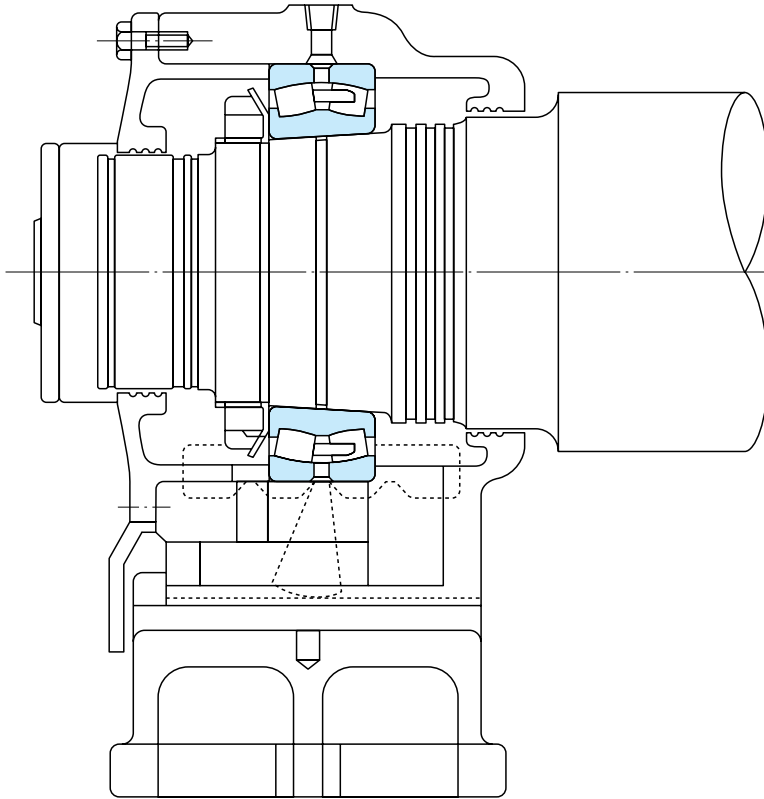

Figure 17 Dryer Roll, Paper Making Machine (Free End)

Bearing No.		23152CAg3MKE4S11
Dimensions (Bore × O.D. × Width)		ϕ 260× ϕ 440×144 mm
Load	Radical	63 kN
	Axial	—
Speed		148 min ⁻¹
Fits		Shaft —
		Housing $^{+0.10}_{+0.05}$
Lubrication		Circulating Lubrication

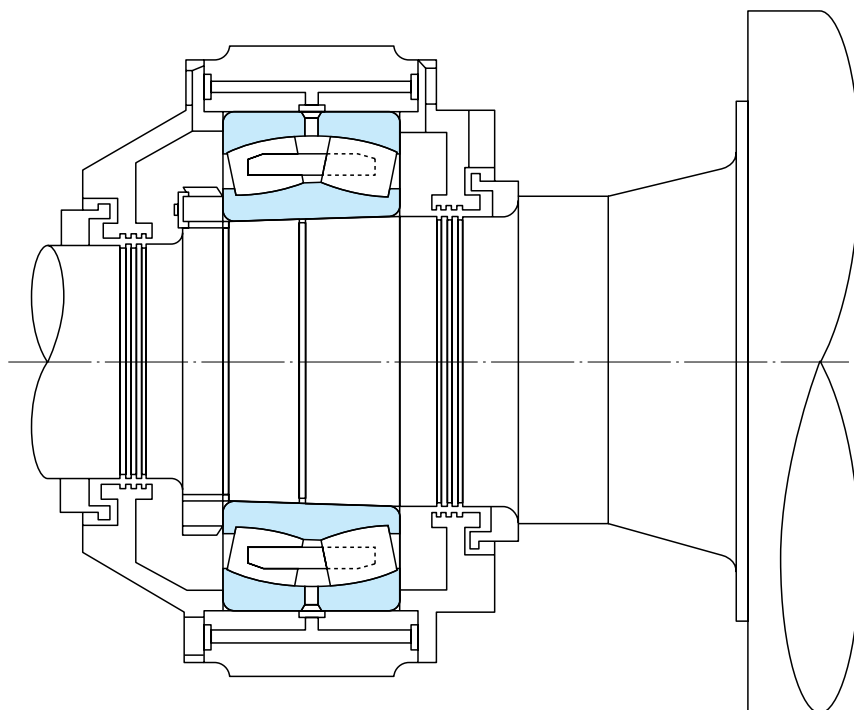

Figure 18 Press Roll, Paper Making Machine (Fixed End)

Bearing No.		23276CAMKE4
Dimensions (Bore × O.D. × Width)		$\phi 380 \times \phi 680 \times 240$ mm
Load	Radical	260 kN
	Axial	—
Speed		341 min^{-1}
Fits		Shaft —
		Housing H7
Lubrication		Circulating Lubrication

Appendix Table 1 Conversion Table from SI (International Units) System

Comparison of SI, CGS, and Engineering Units

Unit System	Length	Mass	Time	Temp.	Acceleration	Force	Stress	Pressure	Energy	Power
SI	m	kg	s	K	m/s^2	N	Pa	Pa	J	W
CGS System	cm	g	s	°C	Gal	dyn	dyn/cm ²	dyn/cm ²	erg	erg/s
Engineering Unit System	m	kgf · s ² /m	s	°C	m/s^2	kgf	kgf/m ²	kgf/m ²	kgf · m	kgf · m/s

Conversion Factors from SI Units

Parameter	SI Units		Units other than SI		Conversion Factors from SI Units
	Names of Units	Symbols	Name of Units	Symbols	
Angle	Radian	rad	Degree Minute Second	° ' "	$180/\pi$ $10\ 800/\pi$ $648\ 000/\pi$
Length	Meter	m	Micrometer Angstrom	μm Å	10^6 10^{10}
Area	Square meter	m ²	Are Hectare	a ha	10^{-2} 10^{-4}
Volume	Cubic meter	m ³	Liter Deciliter	l, L dl, dL	10^3 10^4
Time	Second	s	Minute Hour Day	min h d	1/60 1/3 600 1/86 400
Frequency	Hertz	Hz	Cycle	s ⁻¹	1
Speed of Rotation	Revolution per second	s ⁻¹	Revolution per minute	rpm	60
Speed	Meter per second	m/s	Kilometer per hour Knot	km/h kn	3 600/1 000 3 600/1 852
Acceleration	Meter per second per second	m/s ²	Gal g	Gal g	10^2 1/9.806 65
Mass	Kilogram	kg	Ton	t	10^{-3}
Force	Newton	N	Kilogram-force Ton-force Dyne	kgf tf dyn	1/9.806 65 1/(9.806 65×10 ³) 10^5
Torque or Moment	Newton · meter	N · m	Kilogram-force meter	kgf · m	1/9.806 65
Stress	Pascal	Pa (N/m ²)	Kilogram-force per square centimeter Kilogram-force per square millimeter	kgf/cm ² kgf/mm ²	1/(9.806 65×10 ⁴) 1/(9.806 65×10 ⁶)

Prefixes Used In SI System

Multiples	Prefix	Symbols	Multiples	Prefix	Symbols
10 ¹⁸	Exa	E	10 ⁻¹	Deci	d
10 ¹⁵	Peta	P	10 ⁻²	Centi	c
10 ¹²	Tera	T	10 ⁻³	Milli	m
10 ⁹	Giga	G	10 ⁻⁶	Micro	μ
10 ⁶	Mega	M	10 ⁻⁹	Nano	n
10 ³	Kilo	k	10 ⁻¹²	Pico	p
10 ²	Hecto	h	10 ⁻¹⁵	Femto	f
10	Deca	da	10 ⁻¹⁸	Ato	a

Conversion Factors from SI Units (Continued)

Parameter	SI Units		Units other than SI		Conversion Factors from SI Units
	Names of Units	Symbols	Name of Units	Symbols	
Pressure	Pascal (Newton per square meter)	Pa (N/m ²)	Kilogram-force per square meter	kgf/m ²	1/9.806 65
			Water Column	mH ₂ O	1/ (9.806 65×10 ³)
			Mercury Column	mmHg	760/ (1.013 25×10 ⁵)
			Torr	Torr	760/ (1.013 25×10 ⁵)
			Bar	bar	10 ⁻⁵
			Atmosphere	atm	1/ (1.013 25×10 ⁵)
Energy	Joule (Newton · meter)	J (N · m)	Erg	erg	10 ⁷
			Calorie (International)	cal _{IT}	1/4.186 8
			Kilogram-force meter	kgf · m	1/9.806 65
			Kilowatt hour	kW · h	1/ (3.6×10 ⁶)
			French horse power hour	PS · h	≈ 3.776 72×10 ⁻⁷
Work	Watt (Joule per second)	W (J/s)	Kilogram-force meter per second	kgf · m/s	1/9.806 65
			Kilocalorie per hour	kcal/h	1/1.163
			French horse power	PS	≈ 1/735.498 8
Viscosity, Viscosity Index	Pascal second	Pa · s	Poise	P	10
Kinematic Viscosity, Kinematic Viscosity Index	Square meter per second	m ² /s	Stokes	St	10 ⁴
			Centistokes	cSt	10 ⁶
Temperature	Kelvin, Degree celsius	K, °C	Degree	°C	(See Note (1))
Electric Current, Magnetomotive Force	Ampere	A	Ampere	A	1
Voltage, Electromotive Force	Volt	V	(Watts per ampere)	(W/A)	1
Magnetic Field Strength	Ampere per meter	A/m	Oersted	Oe	4π/10 ³
Magnetic Flux Density	Tesla	T	Gauss	Gs	10 ⁴
			Gamma	γ	10 ⁹
Electrical Resistance	Ohm	Ω	(Volts per ampere)	(V/A)	1

Note (1) The conversion from T K into θ °C is $\theta = T - 273.15$ but for a temperature difference, it is $\Delta T = \Delta \theta$. However, ΔT and $\Delta \theta$ represent temperature differences measured using the Kelvin and Celsius scales respectively.

Remarks The names and symbols in () are equivalent to those directly above them or on their left.
Example of conversion 1N=1/9.806 65kgf

Appendix Table 2 N-kgf Conversion Table

(Method of using this table) For example, to convert 10N into kgf, read the figure in the right kgf column adjacent to the 10 in the center column in the 1st block. This means that 10N is 1.0197kgf. To convert 10kgf into N, read the figure in the left N column of the same row, which indicates that the answer is 98.066N.

$$1 \text{ N} = 0.1019716 \text{ kgf}$$

$$1 \text{ kgf} = 9.80665 \text{ N}$$

N		kgf	N		kgf	N		kgf
9.8066	1	0.1020	333.43	34	3.4670	657.05	67	6.8321
19.613	2	0.2039	343.23	35	3.5690	666.85	68	6.9341
29.420	3	0.3059	353.04	36	3.6710	676.66	69	7.0360
39.227	4	0.4079	362.85	37	3.7729	686.47	70	7.1380
49.033	5	0.5099	372.65	38	3.8749	696.27	71	7.2400
58.840	6	0.6118	382.46	39	3.9769	706.08	72	7.3420
68.647	7	0.7138	392.27	40	4.0789	715.89	73	7.4439
78.453	8	0.8158	402.07	41	4.1808	725.69	74	7.5459
88.260	9	0.9177	411.88	42	4.2828	735.50	75	7.6479
98.066	10	1.0197	421.69	43	4.3848	745.31	76	7.7498
107.87	11	1.1217	431.49	44	4.4868	755.11	77	7.8518
117.68	12	1.2237	441.30	45	4.5887	764.92	78	7.9538
127.49	13	1.3256	451.11	46	4.6907	774.73	79	8.0558
137.29	14	1.4276	460.91	47	4.7927	784.53	80	8.1577
147.10	15	1.5296	470.72	48	4.8946	794.34	81	8.2597
156.91	16	1.6315	480.53	49	4.9966	804.15	82	8.3617
166.71	17	1.7335	490.33	50	5.0986	813.95	83	8.4636
176.52	18	1.8355	500.14	51	5.2006	823.76	84	8.5656
186.33	19	1.9375	509.95	52	5.3025	833.57	85	8.6676
196.13	20	2.0394	519.75	53	5.4045	843.37	86	8.7696
205.94	21	2.1414	529.56	54	5.5065	853.18	87	8.8715
215.75	22	2.2434	539.37	55	5.6084	862.99	88	8.9735
225.55	23	2.3453	549.17	56	5.7104	872.79	89	9.0755
235.36	24	2.4473	558.98	57	5.8124	882.60	90	9.1774
245.17	25	2.5493	568.79	58	5.9144	892.41	91	9.2794
254.97	26	2.6513	578.59	59	6.0163	902.21	92	9.3814
264.78	27	2.7532	588.40	60	6.1183	912.02	93	9.4834
274.59	28	2.8552	598.21	61	6.2203	921.83	94	9.5853
284.39	29	2.9572	608.01	62	6.3222	931.63	95	9.6873
294.20	30	3.0591	617.82	63	6.4242	941.44	96	9.7893
304.01	31	3.1611	627.63	64	6.5262	951.25	97	9.8912
313.81	32	3.2631	637.43	65	6.6282	961.05	98	9.9932
323.62	33	3.3651	647.24	66	6.7301	970.86	99	10.095

Appendix Table 3 kg-lb Conversion Table

(Method of using this table) For example, to convert 10kg into lb, read the figure in the right lb column adjacent to the 10 in the center column in the 1st block. This means that 10kg is 22.046lb. To convert 10lb into kg, read the figure in the left kg column of the same row, which indicates that the answer is 4.536kg.

1 kg = 2.2046226 lb
1 lb = 0.45359237 kg

kg		lb	kg		lb	kg		lb
0.454	1	2.205	15.422	34	74.957	30.391	67	147.71
0.907	2	4.409	15.876	35	77.162	30.844	68	149.91
1.361	3	6.614	16.329	36	79.366	31.298	69	152.12
1.814	4	8.818	16.783	37	81.571	31.751	70	154.32
2.268	5	11.023	17.237	38	83.776	32.205	71	156.53
2.722	6	13.228	17.690	39	85.980	32.659	72	158.73
3.175	7	15.432	18.144	40	88.185	33.112	73	160.94
3.629	8	17.637	18.597	41	90.390	33.566	74	163.14
4.082	9	19.842	19.051	42	92.594	34.019	75	165.35
4.536	10	22.046	19.504	43	94.799	34.473	76	167.55
4.990	11	24.251	19.958	44	97.003	34.927	77	169.76
5.443	12	26.455	20.412	45	99.208	35.380	78	171.96
5.897	13	28.660	20.865	46	101.41	35.834	79	174.17
6.350	14	30.865	21.319	47	103.62	36.287	80	176.37
6.804	15	33.069	21.772	48	105.82	36.741	81	178.57
7.257	16	35.274	22.226	49	108.03	37.195	82	180.78
7.711	17	37.479	22.680	50	110.23	37.648	83	182.98
8.165	18	39.683	23.133	51	112.44	38.102	84	185.19
8.618	19	41.888	23.587	52	114.64	38.555	85	187.39
9.072	20	44.092	24.040	53	116.84	39.009	86	189.60
9.525	21	46.297	24.494	54	119.05	39.463	87	191.80
9.979	22	48.502	24.948	55	121.25	39.916	88	194.01
10.433	23	50.706	25.401	56	123.46	40.370	89	196.21
10.886	24	52.911	25.855	57	125.66	40.823	90	198.42
11.340	25	55.116	26.308	58	127.87	41.277	91	200.62
11.793	26	57.320	26.762	59	130.07	41.730	92	202.83
12.247	27	59.525	27.216	60	132.28	42.184	93	205.03
12.701	28	61.729	27.669	61	134.48	42.638	94	207.23
13.154	29	63.934	28.123	62	136.69	43.091	95	209.44
13.608	30	66.139	28.576	63	138.89	43.545	96	211.64
14.061	31	68.343	29.030	64	141.10	43.998	97	213.85
14.515	32	70.548	29.484	65	143.30	44.452	98	216.05
14.969	33	72.753	29.937	66	145.51	44.906	99	218.26

Appendix Table 4 °C-°F Conversion Table

(Method of using this table) For example, to convert 38°C into °F, read the figure in the right °F column adjacent to the 38 in the center column in the 2nd block. This means that 38°C is 100.4°F. To convert 38°F into °C, read the figure in the left °C column of the same row, which indicates that the answer is 3.3°C.

$$C = \frac{9}{5}(F-32)$$

$$F = 32 + \frac{9}{5}C$$

°C		°F	°C		°F	°C		°F	°C		°F
-73.3	-100	-148.0	0.0	32	89.6	21.7	71	159.8	43.3	110	230
-62.2	- 80	-112.0	0.6	33	91.4	22.2	72	161.6	46.1	115	239
-51.1	- 60	- 76.0	1.1	34	93.2	22.8	73	163.4	48.9	120	248
-40.0	- 40	- 40.0	1.7	35	95.0	23.3	74	165.2	51.7	125	257
-34.4	- 30	- 22.0	2.2	36	96.8	23.9	75	167.0	54.4	130	266
-28.9	- 20	- 4.0	2.8	37	98.6	24.4	76	168.8	57.2	135	275
-23.3	- 10	14.0	3.3	38	100.4	25.0	77	170.6	60.0	140	284
-17.8	 0	32.0	3.9	39	102.2	25.6	78	172.4	65.6	150	302
-17.2	 1	33.8	4.4	40	104.0	26.1	79	174.2	71.1	160	320
-16.7	 2	35.6	5.0	41	105.8	26.7	80	176.0	76.7	170	338
-16.1	 3	37.4	5.6	42	107.6	27.2	81	177.8	82.2	180	356
-15.6	 4	39.2	6.1	43	109.4	27.8	82	179.6	87.8	190	374
-15.0	 5	41.0	6.7	44	111.2	28.3	83	181.4	93.3	200	392
-14.4	 6	42.8	7.2	45	113.0	28.9	84	183.2	98.9	210	410
-13.9	 7	44.6	7.8	46	114.8	29.4	85	185.0	104.4	220	428
-13.3	 8	46.4	8.3	47	116.6	30.0	86	186.8	110.0	230	446
-12.8	 9	48.2	8.9	48	118.4	30.6	87	188.6	115.6	240	464
-12.2	10	50.0	9.4	49	120.2	31.1	88	190.4	121.1	250	482
-11.7	11	51.8	10.0	50	122.0	31.7	89	192.2	148.9	300	572
-11.1	12	53.6	10.6	51	123.8	32.2	90	194.0	176.7	350	662
-10.6	13	55.4	11.1	52	125.6	32.8	91	195.8	204	400	752
-10.0	14	57.2	11.7	53	127.4	33.3	92	197.6	232	450	842
- 9.4	15	59.0	12.2	54	129.2	33.9	93	199.4	260	500	932
- 8.9	16	60.8	12.8	55	131.0	34.4	94	201.2	288	550	1022
- 8.3	17	62.6	13.3	56	132.8	35.0	95	203.0	316	600	1112
- 7.8	18	64.4	13.9	57	134.6	35.6	96	204.8	343	650	1202
- 7.2	19	66.2	14.4	58	136.4	36.1	97	206.6	371	700	1292
- 6.7	20	68.0	15.0	59	138.2	36.7	98	208.4	399	750	1382
- 6.1	21	69.8	15.6	60	140.0	37.2	99	210.2	427	800	1472
- 5.6	22	71.6	16.1	61	141.8	37.8	100	212.0	454	850	1562
- 5.0	23	73.4	16.7	62	143.6	38.3	101	213.8	482	900	1652
- 4.4	24	75.2	17.2	63	145.4	38.9	102	215.6	510	950	1742
- 3.9	25	77.0	17.8	64	147.2	39.4	103	217.4	538	1 000	1832
- 3.3	26	78.8	18.3	65	149.0	40.0	104	219.2	593	1 100	2012
- 2.8	27	80.6	18.9	66	150.8	40.6	105	221.0	649	1 200	2192
- 2.2	28	82.4	19.4	67	152.6	41.1	106	222.8	704	1 300	2372
- 1.7	29	84.2	20.0	68	154.4	41.7	107	224.6	760	1 400	2552
- 1.1	30	86.0	20.6	69	156.2	42.2	108	226.4	816	1 500	2732
- 0.6	31	87.8	21.1	70	158.0	42.8	109	228.2	871	1 600	2912

Appendix Table 5 Viscosity Conversion Table

Kinematic Viscosity mm ² /s	Saybolt Universal SUS (sec)		No.1 Type Redwood R (sec)		Engler E (degree)	Kinematic Viscosity mm ² /s	Saybolt Universal SUS (sec)		No.1 Type Redwood R (sec)		Engler E (degree)
	100°F	210°F	50°C	100°C			100°F	210°F	50°C	100°C	
2	32.6	32.8	30.8	31.2	1.14	35	163	164	144	147	4.70
3	36.0	36.3	33.3	33.7	1.22	36	168	170	148	151	4.83
4	39.1	39.4	35.9	36.5	1.31	37	172	173	153	155	4.96
5	42.3	42.6	38.5	39.1	1.40	38	177	178	156	159	5.08
6	45.5	45.8	41.1	41.7	1.48	39	181	183	160	164	5.21
7	48.7	49.0	43.7	44.3	1.56	40	186	187	164	168	5.34
8	52.0	52.4	46.3	47.0	1.65	41	190	192	168	172	5.47
9	55.4	55.8	49.1	50.0	1.75	42	195	196	172	176	5.59
10	58.8	59.2	52.1	52.9	1.84	43	199	201	176	180	5.72
11	62.3	62.7	55.1	56.0	1.93	44	204	205	180	185	5.85
12	65.9	66.4	58.2	59.1	2.02	45	208	210	184	189	5.98
13	69.6	70.1	61.4	62.3	2.12	46	213	215	188	193	6.11
14	73.4	73.9	64.7	65.6	2.22	47	218	219	193	197	6.24
15	77.2	77.7	68.0	69.1	2.32	48	222	224	197	202	6.37
16	81.1	81.7	71.5	72.6	2.43	49	227	228	201	206	6.50
17	85.1	85.7	75.0	76.1	2.54	50	231	233	205	210	6.63
18	89.2	89.8	78.6	79.7	2.64	55	254	256	225	231	7.24
19	93.3	94.0	82.1	83.6	2.76	60	277	279	245	252	7.90
20	97.5	98.2	85.8	87.4	2.87	65	300	302	266	273	8.55
21	102	102	89.5	91.3	2.98	70	323	326	286	294	9.21
22	106	107	93.3	95.1	3.10	75	346	349	306	315	9.89
23	110	111	97.1	98.9	3.22	80	371	373	326	336	10.5
24	115	115	101	103	3.34	85	394	397	347	357	11.2
25	119	120	105	107	3.46	90	417	420	367	378	11.8
26	123	124	109	111	3.58	95	440	443	387	399	12.5
27	128	129	112	115	3.70	100	464	467	408	420	13.2
28	132	133	116	119	3.82	120	556	560	490	504	15.8
29	137	138	120	123	3.95	140	649	653	571	588	18.4
30	141	142	124	127	4.07	160	742	747	653	672	21.1
31	145	146	128	131	4.20	180	834	840	734	757	23.7
32	150	150	132	135	4.32	200	927	933	816	841	26.3
33	154	155	136	139	4.45	250	1 159	1 167	1 020	1 051	32.9
34	159	160	140	143	4.57	300	1 391	1 400	1 224	1 241	39.5

Remarks 1mm²/s=1cSt

Appendix Table 6 inch-mm Conversion Table

1" = 25.4 mm

inch		0	1	2	3	4	5	6	7	8	9	10
Fraction	Decimal	mm										
0	0.000000	0.000	25.400	50.800	76.200	101.600	127.000	152.400	177.800	203.200	228.600	254.000
1/64	0.015625	0.397	25.797	51.197	76.597	101.997	127.397	152.797	178.197	203.597	228.997	254.397
1/32	0.031250	0.794	26.194	51.594	76.994	102.394	127.794	153.194	178.594	203.994	229.394	254.794
3/64	0.046875	1.191	26.591	51.991	77.391	102.791	128.191	153.591	178.991	204.391	229.791	255.191
1/16	0.062500	1.588	26.988	52.388	77.788	103.188	128.588	153.988	179.388	204.788	230.188	255.588
5/64	0.078125	1.984	27.384	52.784	78.184	103.584	128.984	154.384	179.784	205.184	230.584	255.984
3/32	0.093750	2.381	27.781	53.181	78.581	103.981	129.381	154.781	180.181	205.581	230.981	256.381
7/64	0.109375	2.778	28.178	53.578	78.978	104.378	129.778	155.178	180.578	205.978	231.378	256.778
1/8	0.125000	3.175	28.575	53.975	79.375	104.775	130.175	155.575	180.975	206.375	231.775	257.175
9/64	0.140625	3.572	28.972	54.372	79.772	105.172	130.572	155.972	181.372	206.772	232.172	257.572
5/32	0.156250	3.969	29.369	54.769	80.169	105.569	130.969	156.369	181.769	207.169	232.569	257.969
11/64	0.171875	4.366	29.766	55.166	80.566	105.966	131.366	156.766	182.166	207.566	232.966	258.366
3/16	0.187500	4.762	30.162	55.562	80.962	106.362	131.762	157.162	182.562	207.962	233.362	258.762
13/64	0.203125	5.159	30.559	55.959	81.359	106.759	132.159	157.559	182.959	208.359	233.759	259.159
7/32	0.218750	5.556	30.956	56.356	81.756	107.156	132.556	157.956	183.356	208.756	234.156	259.556
15/64	0.234375	5.953	31.353	56.753	82.153	107.553	132.953	158.353	183.753	209.153	234.553	259.953
1/4	0.250000	6.350	31.750	57.150	82.550	107.950	133.350	158.750	184.150	209.550	234.950	260.350
17/64	0.265625	6.747	32.147	57.547	82.947	108.347	133.747	159.147	184.547	209.947	235.347	260.747
9/32	0.281250	7.144	32.544	57.944	83.344	108.744	134.144	159.544	184.944	210.344	235.744	261.144
19/64	0.296875	7.541	32.941	58.341	83.741	109.141	134.541	159.941	185.341	210.741	236.141	261.541
5/16	0.312500	7.938	33.338	58.738	84.138	109.538	134.938	160.338	185.738	211.138	236.538	261.938
21/64	0.328125	8.334	33.734	59.134	84.534	109.934	135.334	160.734	186.134	211.534	236.934	262.334
11/32	0.343750	8.731	34.131	59.531	84.931	110.331	135.731	161.131	186.531	211.931	237.331	262.731
23/64	0.359375	9.128	34.528	59.928	85.328	110.728	136.128	161.528	186.928	212.328	237.728	263.128
3/8	0.375000	9.525	34.925	60.325	85.725	111.125	136.525	161.925	187.325	212.725	238.125	263.525
25/64	0.390625	9.922	35.322	60.722	86.122	111.522	136.922	162.322	187.722	213.122	238.522	263.922
13/32	0.406250	10.319	35.719	61.119	86.519	111.919	137.319	162.719	188.119	213.519	238.919	264.319
27/64	0.421875	10.716	36.116	61.516	86.916	112.316	137.716	163.116	188.516	213.916	239.316	264.716
7/16	0.437500	11.112	36.512	61.912	87.312	112.712	138.112	163.512	188.912	214.312	239.712	265.112
29/64	0.453125	11.509	36.909	62.309	87.709	113.109	138.509	163.909	189.309	214.709	240.109	265.509
15/32	0.468750	11.906	37.306	62.706	88.106	113.506	138.906	164.306	189.706	215.106	240.506	265.906
31/64	0.484375	12.303	37.703	63.103	88.503	113.903	139.303	164.703	190.103	215.503	240.903	266.303
1/2	0.500000	12.700	38.100	63.500	88.900	114.300	139.700	165.100	190.500	215.900	241.300	266.700
33/64	0.515625	13.097	38.497	63.897	89.297	114.697	140.097	165.497	190.897	216.297	241.697	267.097
17/32	0.531250	13.494	38.894	64.294	89.694	115.094	140.494	165.894	191.294	216.694	242.094	267.494
35/64	0.546875	13.891	39.291	64.691	90.091	115.491	140.891	166.291	191.691	217.091	242.491	267.891
9/16	0.562500	14.288	39.688	65.088	90.488	115.888	141.288	166.688	192.088	217.488	242.888	268.288
37/64	0.578125	14.684	40.084	65.484	90.884	116.284	141.684	167.084	192.484	217.884	243.284	268.684
19/32	0.593750	15.081	40.481	65.881	91.281	116.681	142.081	167.481	192.881	218.281	243.681	269.081
39/64	0.609375	15.478	40.878	66.278	91.678	117.078	142.478	167.878	193.278	218.678	244.078	269.478
5/8	0.625000	15.875	41.275	66.675	92.075	117.475	142.875	168.275	193.675	219.075	244.475	269.875
41/64	0.640625	16.272	41.672	67.072	92.472	117.872	143.272	168.672	194.072	219.472	244.872	270.272
21/32	0.656250	16.669	42.069	67.469	92.869	118.269	143.669	169.069	194.469	219.869	245.269	270.669
43/64	0.671875	17.066	42.466	67.866	93.266	118.666	144.066	169.466	194.866	220.266	245.666	271.066
11/16	0.687500	17.462	42.862	68.262	93.662	119.062	144.462	169.862	195.262	220.662	246.062	271.462
45/64	0.703125	17.859	43.259	68.659	94.059	119.459	144.859	170.259	195.659	221.059	246.459	271.859
23/32	0.718750	18.256	43.656	69.056	94.456	119.856	145.256	170.656	196.056	221.456	246.856	272.256
47/64	0.734375	18.653	44.053	69.453	94.853	120.253	145.653	171.053	196.453	221.853	247.253	272.653
3/4	0.750000	19.050	44.450	69.850	95.250	120.650	146.050	171.450	196.850	222.250	247.650	273.050
49/64	0.765625	19.447	44.847	70.247	95.647	121.047	146.447	171.847	197.247	222.647	248.047	273.447
25/32	0.781250	19.844	45.244	70.644	96.044	121.444	146.844	172.244	197.644	223.044	248.444	273.844
51/64	0.796875	20.241	45.641	71.041	96.441	121.841	147.241	172.641	198.041	223.441	248.841	274.241
13/16	0.812500	20.638	46.038	71.438	96.838	122.238	147.638	173.038	198.438	223.838	249.238	274.638
53/64	0.828125	21.034	46.434	71.834	97.234	122.634	148.034	173.434	198.834	224.234	249.634	275.034
27/32	0.843750	21.431	46.831	72.231	97.631	123.031	148.431	173.831	199.231	224.631	250.031	275.431
55/64	0.859375	21.828	47.228	72.628	98.028	123.428	148.828	174.228	199.628	225.028	250.428	275.828
7/8	0.875000	22.225	47.625	73.025	98.425	123.825	149.225	174.625	200.025	225.425	250.825	276.225
57/64	0.890625	22.622	48.022	73.422	98.822	124.222	149.622	175.022	200.422	225.822	251.222	276.622
29/32	0.906250	23.019	48.419	73.819	99.219	124.619	150.019	175.419	200.819	226.219	251.619	277.019
59/64	0.921875	23.416	48.816	74.216	99.616	125.016	150.416	175.816	201.216	226.616	252.016	277.416
15/16	0.937500	23.812	49.212	74.612	100.012	125.412	150.812	176.212	201.612	227.012	252.412	277.812
61/64	0.953125	24.209	49.609	75.009	100.409	125.809	151.209	176.609	202.009	227.409	252.809	278.209
31/32	0.968750	24.606	50.006	75.406	100.806	126.206	151.606	177.006	202.406	227.806	253.206	278.606
63/64	0.984375	25.003	50.403	75.803	101.203	126.603	152.003	177.403	202.803	228.203	253.603	279.003

1" = 25.4mm

inch		11	12	13	14	15	16	17	18	19	20
Fraction	Decimal	mm									
0	0.0000	279.400	304.800	330.200	355.600	381.000	406.400	431.800	457.200	482.600	508.000
1/16	0.0625	280.988	306.388	331.788	357.188	382.588	407.988	433.388	458.788	484.188	509.588
1/8	0.1250	282.575	307.975	333.375	358.775	384.175	409.575	434.975	460.375	485.775	511.175
3/16	0.1875	284.162	309.562	334.962	360.362	385.762	411.162	436.562	461.962	487.362	512.762
1/4	0.2500	285.750	311.150	336.550	361.950	387.350	412.750	438.150	463.550	488.950	514.350
5/16	0.3125	287.338	312.738	338.138	363.538	388.938	414.338	439.738	465.138	490.538	515.938
3/8	0.3750	288.925	314.325	339.725	365.125	390.525	415.925	441.325	466.725	492.125	517.525
7/16	0.4375	290.512	315.912	341.312	366.712	392.112	417.512	442.912	468.312	493.712	519.112
1/2	0.5000	292.100	317.500	342.900	368.300	393.700	419.100	444.500	469.900	495.300	520.700
9/16	0.5625	293.688	319.088	344.488	369.888	395.288	420.688	446.088	471.488	496.888	522.288
5/8	0.6250	295.275	320.675	346.075	371.475	396.875	422.275	447.675	473.075	498.475	523.875
11/16	0.6875	296.862	322.262	347.662	373.062	398.462	423.862	449.262	474.662	500.062	525.462
3/4	0.7500	298.450	323.850	349.250	374.650	400.050	425.450	450.850	476.250	501.650	527.050
13/16	0.8125	300.038	325.438	350.838	376.238	401.638	427.038	452.438	477.838	503.238	528.638
7/8	0.8750	301.625	327.025	352.425	377.825	403.225	428.625	454.025	479.425	504.825	530.225
15/16	0.9375	303.212	328.612	354.012	379.412	404.812	430.212	455.612	481.012	506.412	531.812

1" = 25.4mm

inch		21	22	23	24	25	26	27	28	29	30
Fraction	Decimal	mm									
0	0.0000	533.400	558.800	584.200	609.600	635.000	660.400	685.800	711.200	736.600	762.000
1/16	0.0625	534.988	560.388	585.788	611.188	636.588	661.988	687.388	712.788	738.188	763.588
1/8	0.1250	536.575	561.975	587.375	612.775	638.175	663.575	688.975	714.375	739.775	765.175
3/16	0.1875	538.162	563.562	588.962	614.362	639.762	665.162	690.562	715.962	741.362	766.762
1/4	0.2500	539.750	565.150	590.550	615.950	641.350	666.750	692.150	717.550	742.950	768.350
5/16	0.3125	541.338	566.738	592.138	617.538	642.938	668.338	693.738	719.138	744.538	769.938
3/8	0.3750	542.925	568.325	593.725	619.125	644.525	669.925	695.325	720.725	746.125	771.525
7/16	0.4375	544.512	569.912	595.312	620.712	646.112	671.512	696.912	722.312	747.712	773.112
1/2	0.5000	546.100	571.500	596.900	622.300	647.700	673.100	698.500	723.900	749.300	774.700
9/16	0.5625	547.688	573.088	598.488	623.888	649.288	674.688	700.088	725.488	750.888	776.288
5/8	0.6250	549.275	574.675	600.075	625.475	650.875	676.275	701.675	727.075	752.475	777.875
11/16	0.6875	550.862	576.262	601.662	627.062	652.462	677.862	703.262	728.662	754.062	779.462
3/4	0.7500	552.450	577.850	603.250	628.650	654.050	679.450	704.850	730.250	755.650	781.050
13/16	0.8125	554.038	579.438	604.838	630.238	655.638	681.038	706.438	731.838	757.238	782.638
7/8	0.8750	555.625	581.025	606.425	631.825	657.225	682.625	708.025	733.425	758.825	784.225
15/16	0.9375	557.212	582.612	608.012	633.412	658.812	684.212	709.612	735.012	760.412	785.812

1" = 25.4mm

inch		31	32	33	34	35	36	37	38	39	40
Fraction	Decimal	mm									
0	0.0000	787.400	812.800	838.200	863.600	889.000	914.400	939.800	965.200	990.600	1016.000
1/16	0.0625	788.988	814.388	839.788	865.188	890.588	915.988	941.388	966.788	992.188	1017.588
1/8	0.1250	790.575	815.975	841.375	866.775	892.175	917.575	942.975	968.375	993.775	1019.175
3/16	0.1875	792.162	817.562	842.962	868.362	893.762	919.162	944.562	969.962	995.362	1020.762
1/4	0.2500	793.750	819.150	844.550	869.950	895.350	920.750	946.150	971.550	996.950	1022.350
5/16	0.3125	795.338	820.738	846.138	871.538	896.938	922.338	947.738	973.138	998.538	1023.938
3/8	0.3750	796.925	822.325	847.725	873.125	898.525	923.925	949.325	974.725	1000.125	1025.525
7/16	0.4375	798.512	823.912	849.312	874.712	900.112	925.512	950.912	976.312	1001.712	1027.112
1/2	0.5000	800.100	825.500	850.900	876.300	901.700	927.100	952.500	977.900	1003.300	1028.700
9/16	0.5625	801.688	827.088	852.488	877.888	903.288	928.688	954.088	979.488	1004.888	1030.288
5/8	0.6250	803.275	828.675	854.075	879.475	904.875	930.275	955.675	981.075	1006.475	1031.875
11/16	0.6875	804.862	830.262	855.662	881.062	906.462	931.862	957.262	982.662	1008.062	1033.462
3/4	0.7500	806.450	831.850	857.250	882.650	908.050	933.450	958.850	984.250	1009.650	1035.050
13/16	0.8125	808.038	833.438	858.838	884.238	909.638	935.038	960.438	985.838	1011.238	1036.638
7/8	0.8750	809.625	835.025	860.425	885.825	911.225	936.625	962.025	987.425	1012.825	1038.225
15/16	0.9375	811.212	836.612	862.012	887.412	912.812	938.212	963.612	989.012	1014.412	1039.812

Appendix Table 7 Hardness Conversion Table (Reference)

Rockwell C Scale Hardness (1 471N) (150kgf)	Vickers Hardness	Brinell Hardness		Rockwell Hardness		Shore Hardness
		Standard Ball	Tungsten Carbide Ball	A Scale	B Scale	
				Load {588.4N {60kgf}} Brale Indenter	Load {980.7N {100kgf}} 1.558mm {1/16in} Ball	
68	940	—	—	85.6	—	97
67	900	—	—	85.0	—	95
66	865	—	—	84.5	—	92
65	832	—	739	83.9	—	91
64	800	—	722	83.4	—	88
63	772	—	705	82.8	—	87
62	746	—	688	82.3	—	85
61	720	—	670	81.8	—	83
60	697	—	654	81.2	—	81
59	674	—	634	80.7	—	80
58	653	—	615	80.1	—	78
57	633	—	595	79.6	—	76
56	613	—	577	79.0	—	75
55	595	—	560	78.5	—	74
54	577	—	543	78.0	—	72
53	560	—	525	77.4	—	71
52	544	500	512	76.8	—	69
51	528	487	496	76.3	—	68
50	513	475	481	75.9	—	67
49	498	464	469	75.2	—	66
48	484	451	455	74.7	—	64
47	471	442	443	74.1	—	63
46	458	432	432	73.6	—	62
45	446	421	421	73.1	—	60
44	434	409	409	72.5	—	58
43	423	400	400	72.0	—	57
42	412	390	390	71.5	—	56
41	402	381	381	70.9	—	55
40	392	371	371	70.4	—	54
39	382	362	362	69.9	—	52
38	372	353	353	69.4	—	51
37	363	344	344	68.9	—	50
36	354	336	336	68.4	(109.0)	49
35	345	327	327	67.9	(108.5)	48
34	336	319	319	67.4	(108.0)	47
33	327	311	311	66.8	(107.5)	46
32	318	301	301	66.3	(107.0)	44
31	310	294	294	65.8	(106.0)	43
30	302	286	286	65.3	(105.5)	42
29	294	279	279	64.7	(104.5)	41
28	286	271	271	64.3	(104.0)	41
27	279	264	264	63.8	(103.0)	40
26	272	258	258	63.3	(102.5)	38
25	266	253	253	62.8	(101.5)	38
24	260	247	247	62.4	(101.0)	37
23	254	243	243	62.0	100.0	36
22	248	237	237	61.5	99.0	35
21	243	231	231	61.0	98.5	35
20	238	226	226	60.5	97.8	34
(18)	230	219	219	—	96.7	33
(16)	222	212	212	—	95.5	32
(14)	213	203	203	—	93.9	31
(12)	204	194	194	—	92.3	29
(10)	196	187	187	—	90.7	28
(8)	188	179	179	—	89.5	27
(6)	180	171	171	—	87.1	26
(4)	173	165	165	—	85.5	25
(2)	166	158	158	—	83.5	24
(0)	160	152	152	—	81.7	24

Appendix Table 8 Physical and Mechanical Properties of Materials

Materials	Specific Gravity	Coefficient of Linear Expansion (0°~100°C) (K ⁻¹)	Hardness (Brinell)	Modulus of Direct Elasticity (MPa) {kgf/mm ² }	Tensile Strength (MPa) {kgf/mm ² }	Yield Point (MPa) {kgf/mm ² }	Elongation (%)	
Bearing Steel (hardened)	7.83	12.5×10 ⁻⁶	650~740	208 000 (21 200)	1 570~1 960 (160~200)	—	—	
Martensitic Stainless Steel SUS 440C	7.68	10.1×10 ⁻⁶	580	200 000 (20 400)	1 960 (200)	1 860 (190)	—	
Mild Steel (C=0.12~0.20%)	7.86	11.6×10 ⁻⁶	100~130	206 000 (21 000)	373~471 (38~48)	216~294 (22~30)	24~36	
Hard Steel (C=0.3~0.5%)	7.84	11.3×10 ⁻⁶	160~200	206 000 (21 000)	539~686 (55~70)	333~451 (34~46)	14~26	
Austenitic Stainless Steel SUS 304	8.03	16.3×10 ⁻⁶	150	193 000 (19 700)	588 (60)	245 (25)	60	
Cast Iron	Gray Iron FC 200	7.3	10.4×10 ⁻⁶	223	98 100 (10 000)	Min. 200 (20)	—	—
	Spheroidal graphite Iron FCD 400	7.0	11.7×10 ⁻⁶	Max. 201		Min. 400 (41)	—	Min. 12
Aluminum	2.69	23.7×10 ⁻⁶	15~26	70 600 (7 200)	78 (8)	34 (3.5)	35	
Zinc	7.14	31×10 ⁻⁶	30~60	92 200 (9 400)	147 (15)	—	30~40	
Copper	8.93	16.2×10 ⁻⁶	50	123 000 (12 500)	196 (20)	69 (7)	15~20	
Brass	(Annealed)	8.5	45	103 000 (10 500)	294~343 (30~35)	—	65~75	
	(Machined)		85~130		363~539 (37~55)		15~50	

Remarks The hardness of hardened bearing steel and martensitic stainless steel is usually expressed using the Rockwell C Scale, but for comparison, it is converted into Brinell hardness.

Appendix Table 9 Tolerances

Diameter Classification (mm)		Single Plane Mean Bore Deviation (Normal) Δd_{mp}	d6	e6	f6	g5	g6	h5	h6	h7	h8	h9	h10	js5	js6
over	incl														
3	6	- 8	- 30 - 38	- 20 - 28	- 10 - 18	- 4 - 9	- 4 - 12	0 - 5	0 - 8	0 - 12	0 - 18	0 - 30	0 - 48	± 2.5	± 4
6	10	- 8	0 - 40 - 49	- 25 - 34	- 13 - 22	- 5 - 11	- 5 - 14	0 - 6	0 - 9	0 - 15	0 - 22	0 - 36	0 - 58	± 3	± 4.5
10	18	- 8	0 - 50 - 61	- 32 - 43	- 16 - 27	- 6 - 14	- 6 - 17	0 - 8	0 - 11	0 - 18	0 - 27	0 - 43	0 - 70	± 4	± 5.5
18	30	0	- 65 - 10	- 40 - 78	- 20 - 53	- 7 - 16	- 7 - 20	0 - 9	0 - 13	0 - 21	0 - 33	0 - 52	0 - 84	± 4.5	± 6.5
30	50	0	- 80 - 12	- 50 - 96	- 25 - 41	- 9 - 20	- 9 - 25	0 - 11	0 - 16	0 - 25	0 - 39	0 - 62	0 - 100	± 5.5	± 8
50	80	0	- 100 - 15	- 60 - 79	- 30 - 49	- 10 - 23	- 10 - 29	0 - 13	0 - 19	0 - 30	0 - 46	0 - 74	0 - 120	± 6.5	± 9.5
80	120	0	- 120 - 20	- 72 - 94	- 36 - 58	- 12 - 27	- 12 - 34	0 - 15	0 - 22	0 - 35	0 - 54	0 - 87	0 - 140	± 7.5	± 11
120	180	0	- 145 - 25	- 85 - 110	- 43 - 68	- 14 - 32	- 14 - 39	0 - 18	0 - 25	0 - 40	0 - 63	0 - 100	0 - 160	± 9	± 12.5
180	250	0	- 170 - 30	- 100 - 199	- 50 - 79	- 15 - 35	- 15 - 44	0 - 20	0 - 29	0 - 46	0 - 72	0 - 115	0 - 185	± 10	± 14.5
250	315	0	- 190 - 35	- 110 - 222	- 56 - 88	- 17 - 40	- 17 - 49	0 - 23	0 - 32	0 - 52	0 - 81	0 - 130	0 - 210	± 11.5	± 16
315	400	0	- 210 - 40	- 125 - 246	- 62 - 98	- 18 - 43	- 18 - 54	0 - 25	0 - 36	0 - 57	0 - 89	0 - 140	0 - 230	± 12.5	± 18
400	500	0	- 230 - 45	- 135 - 270	- 68 - 108	- 20 - 47	- 20 - 60	0 - 27	0 - 40	0 - 63	0 - 97	0 - 155	0 - 250	± 13.5	± 20
500	630	0	- 260 - 50	- 145 - 304	- 76 - 120	—	- 22 - 66	—	0 - 44	0 - 70	0 - 110	0 - 175	0 - 280	—	± 22
630	800	0	- 290 - 75	- 160 - 340	- 80 - 130	—	- 24 - 74	—	0 - 50	0 - 80	0 - 125	0 - 200	0 - 320	—	± 25
800	1 000	0	- 320 - 100	- 170 - 376	- 86 - 142	—	- 26 - 82	—	0 - 56	0 - 90	0 - 140	0 - 230	0 - 360	—	± 28
1 000	1 250	0	- 350 - 125	- 195 - 416	- 98 - 164	—	- 28 - 94	—	0 - 66	0 - 105	0 - 165	0 - 260	0 - 420	—	± 33
1 250	1 600	0	- 390 - 160	- 220 - 468	- 110 - 188	—	- 30 - 108	—	0 - 78	0 - 125	0 - 195	0 - 310	0 - 500	—	± 39
1 600	2 000	0	- 430 - 200	- 240 - 522	- 120 - 212	—	- 32 - 124	—	0 - 92	0 - 150	0 - 230	0 - 370	0 - 600	—	± 46

for Shaft Diameters

Units: μm

j5	j6	j7	k5	k6	k7	m5	m6	n6	p6	r6	r7	Diameter Classification (mm)	
												over	incl
+3 -2	+6 -2	+8 -4	+6 +1	+9 +1	+13 +1	+9 +4	+12 +4	+16 +8	+20 +12	+23 +15	+27 +15	3	6
+4 -2	+7 -2	+10 -5	+7 +1	+10 +1	+16 +1	+12 +6	+15 +6	+19 +10	+24 +15	+28 +19	+34 +19	6	10
+5 -3	+8 -3	+12 -6	+9 +1	+12 +1	+19 +1	+15 +7	+18 +7	+23 +7	+29 +12	+34 +23	+41 +23	10	18
+5 -4	+9 -4	+13 -8	+11 +2	+15 +2	+23 +2	+17 +8	+21 +8	+28 +15	+35 +22	+41 +28	+49 +28	18	30
+6 -5	+11 -5	+15 -10	+13 +2	+18 +2	+27 +2	+20 +9	+25 +9	+33 +17	+42 +26	+50 +34	+59 +34	30	50
+6 -7	+12 -7	+18 -12	+15 +2	+21 +2	+32 +2	+24 +11	+30 +11	+39 +20	+51 +32	+60 +41	+71 +41	50	65
										+62 +43	+73 +43	65	80
+6 -9	+13 -9	+20 -15	+18 +3	+25 +3	+38 +3	+28 +13	+35 +13	+45 +23	+59 +37	+73 +51	+86 +51	80	100
										+76 +54	+89 +54	100	120
+7 -11	+14 -11	+22 -18	+21 +3	+28 +3	+43 +3	+33 +15	+40 +15	+52 +27	+68 +43	+88 +63	+103 +63	120	140
										+90 +65	+105 +65	140	160
+7 -13	+16 -13	+25 -21	+24 +4	+33 +4	+50 +4	+37 +17	+46 +17	+60 +31	+79 +50	+93 +68	+108 +68	160	180
										+106 +77	+123 +77	180	200
+7 -16	±16	±26	+27 +4	+36 +4	+56 +4	+43 +20	+52 +20	+66 +34	+88 +56	+109 +80	+126 +80	200	225
										+113 +84	+130 +84	225	250
+7 -18	±18	+29 -28	+29 +4	+40 +4	+61 +4	+46 +21	+57 +21	+73 +37	+98 +62	+126 +94	+146 +94	250	280
										+130 +98	+150 +98	280	315
+7 -20	±20	+31 -32	+32 +5	+45 +5	+68 +5	+50 +23	+63 +23	+80 +40	+108 +68	+144 +108	+165 +108	315	355
										+150 +114	+171 +114	355	400
—	—	—	—	+44 0	+70 0	—	+70 +26	+88 +44	+122 +78	+166 +126	+189 +126	400	450
										+172 +132	+195 +132	450	500
—	—	—	—	+50 0	+80 0	—	+80 +30	+100 +50	+138 +88	+194 +150	+220 +150	500	560
										+199 +155	+225 +155	560	630
—	—	—	—	+56 0	+90 0	—	+90 +34	+112 +56	+156 +100	+225 +175	+255 +175	630	710
										+235 +185	+265 +185	710	800
—	—	—	—	+66 0	+105 0	—	+106 +40	+132 +66	+186 +120	+266 +210	+300 +210	800	900
										+276 +220	+310 +220	900	1000
—	—	—	—	+78 0	+125 0	—	+126 +48	+156 +78	+218 +140	+316 +250	+355 +250	1000	1120
										+326 +260	+365 +260	1120	1250
—	—	—	—	+92 0	+150 0	—	+150 +58	+184 +92	+262 +170	+378 +300	+425 +300	1250	1400
										+408 +330	+455 +330	1400	1600
—	—	—	—	+92 0	+150 0	—	+150 +58	+184 +92	+262 +170	+462 +370	+520 +370	1600	1800
										+492 +400	+550 +400	1800	2000

Appendix Table 10

Diameter Classification (mm)		Single Plane Mean O.D. Deviation (Normal) ΔD_{mp}	E6	F6	F7	G6	G7	H6	H7	H8	J6	J7	JS6	JS7
over	incl													
10	18	0 - 8	+ 43 + 32	+ 27 + 16	+ 34 + 16	+ 17 + 6	+ 24 + 6	+ 11 0	+ 18 0	+ 27 0	+ 6 - 5	+ 10 - 8	± 5.5	± 9
18	30	0 - 9	+ 53 + 40	+ 33 + 20	+ 41 + 20	+ 20 + 7	+ 28 + 7	+ 13 0	+ 21 0	+ 33 0	+ 8 - 5	+ 12 - 9	± 6.5	±10.5
30	50	0 - 11	+ 66 + 50	+ 41 + 25	+ 50 + 25	+ 25 + 9	+ 34 + 9	+ 16 0	+ 25 0	+ 39 0	+10 - 6	+14 -11	± 8	±12.5
50	80	0 - 13	+ 79 + 60	+ 49 + 30	+ 60 + 30	+ 29 + 10	+ 40 + 10	+ 19 0	+ 30 0	+ 46 0	+13 - 6	+18 -12	± 9.5	±15
80	120	0 - 15	+ 94 + 72	+ 58 + 36	+ 71 + 36	+ 34 + 12	+ 47 + 12	+ 22 0	+ 35 0	+ 54 0	+16 - 6	+22 -13	±11	±17.5
120 150	150 180	0 - 18 0 - 25	+110 + 85	+ 68 + 43	+ 83 + 43	+ 39 + 14	+ 54 + 14	+ 25 0	+ 40 0	+ 63 0	+18 - 7	+26 -14	±12.5	±20
180	250	0 - 30	+129 +100	+ 79 + 50	+ 96 + 50	+ 44 + 15	+ 61 + 15	+ 29 0	+ 46 0	+ 72 0	+22 - 7	+30 -16	±14.5	±23
250	315	0 - 35	+142 +110	+ 88 + 56	+108 + 56	+ 49 + 17	+ 69 + 17	+ 32 0	+ 52 0	+ 81 0	+25 - 7	+36 -16	±16	±26
315	400	0 - 40	+161 +125	+ 98 + 62	+119 + 62	+ 54 + 18	+ 75 + 18	+ 36 0	+ 57 0	+ 89 0	+29 - 7	+39 -18	±18	±28.5
400	500	0 - 45	+175 +135	+108 + 68	+131 + 68	+ 60 + 20	+ 83 + 20	+ 40 0	+ 63 0	+ 97 0	+33 - 7	+43 -20	±20	±31.5
500	630	0 - 50	+189 +145	+120 + 76	+146 + 76	+ 66 + 22	+ 92 + 22	+ 44 0	+ 70 0	+110 0	—	—	±22	±35
630	800	0 - 75	+210 +160	+130 + 80	+160 + 80	+ 74 + 24	+104 + 24	+ 50 0	+ 80 0	+125 0	—	—	±25	±40
800	1 000	0 -100	+226 +170	+142 + 86	+176 + 86	+ 82 + 26	+116 + 26	+ 56 0	+ 90 0	+140 0	—	—	±28	±45
1 000	1 250	0 -125	+261 +195	+164 + 98	+203 + 98	+ 94 + 28	+133 + 28	+ 66 0	+105 0	+165 0	—	—	±33	±52.5
1 250	1 600	0 -160	+298 +220	+188 +110	+235 +110	+108 + 30	+155 + 30	+ 78 0	+125 0	+195 0	—	—	±39	±62.5
1 600	2 000	0 -200	+332 +240	+212 +120	+270 +120	+124 + 32	+182 + 32	+ 92 0	+150 0	+230 0	—	—	±46	±75
2 000	2 500	0 -250	+370 +260	+240 +130	+305 +130	+144 + 34	+209 + 34	+110 0	+175 0	+280 0	—	—	±55	±87.5

Tolerances for Housing Bore Diameters

Units:μm

K5	K6	K7	M5	M6	M7	N5	N6	N7	P6	P7	Diameter Classification (mm)	
											over	incl
+ 2 - 6	+ 2 - 9	+ 6 - 12	- 4 - 12	- 4 - 15	0 - 18	- 9 - 17	- 9 - 20	- 5 - 23	- 15 - 26	- 11 - 29	10	18
+ 1 - 8	+ 2 - 11	+ 6 - 15	- 5 - 14	- 4 - 17	0 - 21	- 12 - 21	- 11 - 24	- 7 - 28	- 18 - 31	- 14 - 35	18	30
+ 2 - 9	+ 3 - 13	+ 7 - 18	- 5 - 16	- 4 - 20	0 - 25	- 13 - 24	- 12 - 28	- 8 - 33	- 21 - 37	- 17 - 42	30	50
+ 3 - 10	+ 4 - 15	+ 9 - 21	- 6 - 19	- 5 - 24	0 - 30	- 15 - 28	- 14 - 33	- 9 - 39	- 26 - 45	- 21 - 51	50	80
+ 2 - 13	+ 4 - 18	+ 10 - 25	- 8 - 23	- 6 - 28	0 - 35	- 18 - 33	- 16 - 38	- 10 - 45	- 30 - 52	- 24 - 59	80	120
+ 3 - 15	+ 4 - 21	+ 12 - 28	- 9 - 27	- 8 - 33	0 - 40	- 21 - 39	- 20 - 45	- 12 - 52	- 36 - 61	- 28 - 68	120	180
+ 2 - 18	+ 5 - 24	+ 13 - 33	- 11 - 31	- 8 - 37	0 - 46	- 25 - 45	- 22 - 51	- 14 - 60	- 41 - 70	- 33 - 79	180	250
+ 3 - 20	+ 5 - 27	+ 16 - 36	- 13 - 36	- 9 - 41	0 - 52	- 27 - 50	- 25 - 57	- 14 - 66	- 47 - 79	- 36 - 88	250	315
+ 3 - 22	+ 7 - 29	+ 17 - 40	- 14 - 39	- 10 - 46	0 - 57	- 30 - 55	- 26 - 62	- 16 - 73	- 51 - 87	- 41 - 98	315	400
+ 2 - 25	+ 8 - 32	+ 18 - 45	- 16 - 43	- 10 - 50	0 - 63	- 33 - 60	- 27 - 67	- 17 - 80	- 55 - 95	- 45 - 108	400	500
—	0 - 44	0 - 70	—	- 26 - 70	- 26 - 96	—	- 44 - 88	- 44 - 114	- 78 - 122	- 78 - 148	500	630
—	0 - 50	0 - 80	—	- 30 - 80	- 30 110	—	- 50 - 100	- 50 - 130	- 88 - 138	- 88 - 168	630	800
—	0 - 56	0 - 90	—	- 34 - 90	- 34 - 124	—	- 56 - 112	- 56 - 146	- 100 - 156	- 100 - 190	800	1 000
—	0 - 66	0 - 105	—	- 40 - 106	- 40 - 145	—	- 66 - 132	- 66 - 171	- 120 - 186	- 120 - 225	1 000	1 250
—	0 - 78	0 - 125	—	- 48 - 126	- 48 - 173	—	- 78 - 156	- 78 - 203	- 140 - 218	- 140 - 265	1 250	1 600
—	0 - 92	0 - 150	—	- 58 - 150	- 58 - 208	—	- 92 - 184	92 - 242	- 170 - 262	- 170 - 320	1 600	2 000
—	0 - 110	0 - 175	—	- 68 - 178	- 68 - 243	—	- 110 - 220	- 110 - 285	- 195 - 305	- 195 - 370	2 000	2 500

Appendix Table 11 Values of

Basic Size (mm)		Standard										
		1	2	3	4	5	6	7	8	9	10	11
over	incl	Tolerances (µm)										
—	3	0.8	1.2	2	3	4	6	10	14	25	40	60
3	6	1	1.5	2.5	4	5	8	12	18	30	48	75
6	10	1	1.5	2.5	4	6	9	15	22	36	58	90
10	18	1.2	2	3	5	8	11	18	27	43	70	110
18	30	1.5	2.5	4	6	9	13	21	33	52	84	130
30	50	1.5	2.5	4	7	11	16	25	39	62	100	160
50	80	2	3	5	8	13	19	30	46	74	120	190
80	120	2.5	4	6	10	15	22	35	54	87	140	220
120	180	3.5	5	8	12	18	25	40	63	100	160	250
180	250	4.5	7	10	14	20	29	46	72	115	185	290
250	315	6	8	12	16	23	32	52	81	130	210	320
315	400	7	9	13	18	25	36	57	89	140	230	360
400	500	8	10	15	20	27	40	63	97	155	250	400
500	630	9	11	16	22	32	44	70	110	175	280	440
630	800	10	13	18	25	36	50	80	125	200	320	500
800	1 000	11	15	21	28	40	56	90	140	230	360	560
1 000	1 250	13	18	24	33	47	66	105	165	260	420	660
1 250	1 600	15	21	29	39	55	78	125	195	310	500	780
1 600	2 000	18	25	35	46	65	92	150	230	370	600	920
2 000	2 500	22	30	41	55	78	110	175	280	440	700	1 100
2 500	3 150	26	36	50	68	96	135	210	330	540	860	1 350

Remarks 1. Standard tolerance grades IT14 to IT18 shall not be used for basic sizes less than or equal to 1mm.
 2. Values for standard tolerance grades IT1 to IT5 for basic sizes over 500mm are included for experimental use.

Standard Tolerance Grades IT

Grades							Basic Size (mm)	
12	13	14	15	16	17	18	over	incl
Tolerances (mm)							over	incl
0.10	0.14	0.25	0.40	0.60	1.00	1.40	—	3
0.12	0.18	0.30	0.48	0.75	1.20	1.80	3	6
0.15	0.22	0.36	0.58	0.90	1.50	2.20	6	10
0.18	0.27	0.43	0.70	1.10	1.80	2.70	10	18
0.21	0.33	0.52	0.84	1.30	2.10	3.30	18	30
0.25	0.39	0.62	1.00	1.60	2.50	3.90	30	50
0.30	0.46	0.74	1.20	1.90	3.00	4.60	50	80
0.35	0.54	0.87	1.40	2.20	3.50	5.40	80	120
0.40	0.63	1.00	1.60	2.50	4.00	6.30	120	180
0.46	0.72	1.15	1.85	2.90	4.60	7.20	180	250
0.52	0.81	1.30	2.10	3.20	5.20	8.10	250	315
0.57	0.89	1.40	2.30	3.60	5.70	8.90	315	400
0.63	0.97	1.55	2.50	4.00	6.30	9.70	400	500
0.70	1.10	1.75	2.80	4.40	7.00	11.00	500	630
0.80	1.25	2.00	3.20	5.00	8.00	12.50	630	800
0.90	1.40	2.30	3.60	5.60	9.00	14.00	800	1 000
1.05	1.65	2.60	4.20	6.60	10.50	16.50	1 000	1 250
1.25	1.95	3.10	5.00	7.80	12.50	19.50	1 250	1 600
1.50	2.30	3.70	6.00	9.20	15.00	23.00	1 600	2 000
1.75	2.80	4.40	7.00	11.00	17.50	28.00	2 000	2 500
2.10	3.30	5.40	8.60	13.50	21.00	33.00	2 500	3 150

Appendix Table 12 Speed Factor f_n

Ball Bearings $f_n = (0.03 n)^{-1/3}$
 Roller Bearings $f_n = (0.03 n)^{-3/10}$

Speed n (rpm)	Speed Factor f_n		Speed n (rpm)	Speed Factor f_n		Speed n (rpm)	Speed Factor f_n	
	Ball Bearings	Roller Bearings		Ball Bearings	Roller Bearings		Ball Bearings	Roller Bearings
10	1.49	1.44	180	0.570	0.603	3 000	0.223	0.259
11	1.45	1.39	190	0.560	0.593	3 200	0.218	0.254
12	1.41	1.36	200	0.550	0.584	3 400	0.214	0.250
13	1.37	1.33	220	0.533	0.568	3 600	0.210	0.245
14	1.34	1.30	240	0.518	0.553	3 800	0.206	0.242
15	1.30	1.27	260	0.504	0.540	4 000	0.203	0.238
16	1.28	1.25	280	0.492	0.528	4 200	0.199	0.234
17	1.25	1.22	300	0.481	0.517	4 400	0.196	0.231
18	1.23	1.20	320	0.471	0.507	4 600	0.194	0.228
19	1.21	1.18	340	0.461	0.498	4 800	0.191	0.225
20	1.19	1.17	360	0.452	0.490	5 000	0.188	0.222
21	1.17	1.15	380	0.444	0.482	5 200	0.186	0.220
22	1.15	1.13	400	0.437	0.475	5 400	0.183	0.217
23	1.13	1.12	420	0.430	0.468	5 600	0.181	0.215
24	1.12	1.10	440	0.423	0.461	5 800	0.179	0.213
25	1.10	1.09	460	0.417	0.455	6 000	0.177	0.211
26	1.09	1.08	480	0.411	0.449	6 200	0.175	0.209
27	1.07	1.07	500	0.405	0.444	6 400	0.173	0.207
28	1.06	1.05	550	0.393	0.431	6 600	0.172	0.205
29	1.05	1.04	600	0.382	0.420	6 800	0.170	0.203
30	1.04	1.03	650	0.372	0.410	7 000	0.168	0.201
31	1.02	1.02	700	0.362	0.401	7 200	0.167	0.199
32	1.01	1.01	750	0.354	0.393	7 400	0.165	0.198
33.3	1.00	1.00	800	0.347	0.385	7 600	0.164	0.196
34	0.993	0.994	850	0.340	0.378	7 800	0.162	0.195
36	0.975	0.977	900	0.333	0.372	8 000	0.161	0.193
38	0.957	0.961	950	0.327	0.366	8 500	0.158	0.190
40	0.941	0.947	1 000	0.322	0.360	9 000	0.155	0.186
42	0.926	0.933	1 050	0.317	0.355	9 500	0.152	0.183
44	0.912	0.920	1 100	0.312	0.350	10 000	0.149	0.181
46	0.898	0.908	1 150	0.307	0.346	11 000	0.145	0.176
48	0.886	0.896	1 200	0.303	0.341	12 000	0.141	0.171
50	0.874	0.885	1 250	0.299	0.337	13 000	0.137	0.167
55	0.846	0.861	1 300	0.295	0.333	14 000	0.134	0.163
60	0.822	0.838	1 400	0.288	0.326	15 000	0.130	0.160
65	0.800	0.818	1 500	0.281	0.319	16 000	0.128	0.157
70	0.781	0.800	1 600	0.275	0.313	17 000	0.125	0.154
75	0.763	0.784	1 700	0.270	0.307	18 000	0.123	0.151
80	0.747	0.769	1 800	0.265	0.302	19 000	0.121	0.149
85	0.732	0.755	1 900	0.260	0.297	20 000	0.119	0.147
90	0.718	0.742	2 000	0.255	0.293	22 000	0.115	0.143
95	0.705	0.730	2 100	0.251	0.289	24 000	0.112	0.139
100	0.693	0.719	2 200	0.247	0.285	26 000	0.109	0.136
110	0.672	0.699	2 300	0.244	0.281	28 000	0.106	0.133
120	0.652	0.681	2 400	0.240	0.277	30 000	0.104	0.130
130	0.635	0.665	2 500	0.237	0.274	32 000	0.101	0.127
140	0.620	0.650	2 600	0.234	0.271	34 000	0.099	0.125
150	0.606	0.637	2 700	0.231	0.268	36 000	0.097	0.123
160	0.593	0.625	2 800	0.228	0.265	38 000	0.096	0.121
170	0.581	0.613	2 900	0.226	0.262	40 000	0.094	0.119

Appendix Table 13 Fatigue Life Factor f_h and Fatigue Life $L \cdot L_h$

Ball Bearings $L=(C/P)^3 \quad L_h=500f_h^3$
 Roller Bearings $L=(C/P)^{10/3} \quad L_h=500f_h^{10/3}$

C/P or f_h	Ball Bearing Life		Roller Bearing Life	
	L	L_h	L	L_h
	(10^6 rev)	(h)	(10^6 rev)	(h)
0.70	0.34	172	0.30	152
0.75	0.42	211	0.38	192
0.80	0.51	256	0.48	238
0.85	0.61	307	0.58	291
0.90	0.73	365	0.70	352
0.95	0.86	429	0.84	421
1.00	1.00	500	1.00	500
1.05	1.16	579	1.18	588
1.10	1.33	665	1.37	687
1.15	1.52	760	1.59	797
1.20	1.73	864	1.84	918
1.25	1.95	977	2.10	1 050
1.30	2.20	1 100	2.40	1 200
1.35	2.46	1 230	2.72	1 360
1.40	2.74	1 370	3.07	1 530
1.45	3.05	1 520	3.45	1 730
1.50	3.38	1 690	3.86	1 930
1.55	3.72	1 860	4.31	2 150
1.60	4.10	2 050	4.79	2 400
1.65	4.49	2 250	5.31	2 650
1.70	4.91	2 460	5.86	2 930
1.75	5.36	2 680	6.46	3 230
1.80	5.83	2 920	7.09	3 550
1.85	6.33	3 170	7.77	3 890
1.90	6.86	3 430	8.50	4 250
1.95	7.41	3 710	9.26	4 630
2.00	8.00	4 000	10.1	5 040
2.05	8.62	4 310	10.9	5 470
2.10	9.26	4 630	11.9	5 930
2.15	9.94	4 970	12.8	6 410
2.20	10.6	5 320	13.8	6 920
2.25	11.4	5 700	14.9	7 460
2.30	12.2	6 080	16.1	8 030
2.35	13.0	6 490	17.3	8 630
2.40	13.8	6 910	18.5	9 250
2.45	14.7	7 350	19.8	9 910
2.50	15.6	7 810	21.2	10 600
2.55	16.6	8 290	22.7	11 300
2.60	17.6	8 790	24.2	12 100
2.65	18.6	9 300	25.8	12 900
2.70	19.7	9 840	27.4	13 700
2.75	20.8	10 400	29.1	14 600
2.80	22.0	11 000	30.9	15 500
2.85	23.1	11 600	32.8	16 400
2.90	24.4	12 200	34.8	17 400
2.95	25.7	12 800	36.8	18 400
3.00	27.0	13 500	38.9	19 500
3.05	28.4	14 200	41.1	20 600
3.10	29.8	14 900	43.4	21 700
3.15	31.3	15 600	45.8	22 900
3.20	32.8	16 400	48.3	24 100
3.25	34.3	17 200	50.8	25 400
3.30	35.9	18 000	53.5	26 800
3.35	37.6	18 800	56.3	28 100
3.40	39.3	19 700	59.1	29 600

C/P or f_h	Ball Bearing Life		Roller Bearing Life	
	L	L_h	L	L_h
	(10^6 rev)	(h)	(10^6 rev)	(h)
3.45	41.1	20 500	62.0	31 000
3.50	42.9	21 400	65.1	32 500
3.55	44.7	22 400	68.2	34 100
3.60	46.7	23 300	71.5	35 800
3.65	48.6	24 300	74.9	37 400
3.70	50.7	25 300	78.3	39 200
3.75	52.7	26 400	81.9	41 000
3.80	54.9	27 400	85.6	42 800
3.85	57.1	28 500	89.4	44 700
3.90	59.3	29 700	93.4	46 700
3.95	61.6	30 800	97.4	48 700
4.00	64.0	32 000	102	50 800
4.05	66.4	33 200	106	52 900
4.10	68.9	34 500	110	55 200
4.15	71.5	35 700	115	57 400
4.20	74.1	37 000	120	59 800
4.25	76.8	38 400	124	62 200
4.30	79.5	39 800	129	64 600
4.35	82.3	41 200	134	67 200
4.40	85.2	42 600	140	69 800
4.45	88.1	44 100	145	72 500
4.50	91.1	45 600	150	75 200
4.55	94.2	47 100	156	78 000
4.60	97.3	48 700	162	80 900
4.65	101	50 300	168	83 900
4.70	104	51 900	174	87 000
4.75	107	53 600	180	90 100
4.80	111	55 300	187	93 300
4.85	114	57 000	193	96 600
4.90	118	58 800	200	99 900
4.95	121	60 600	207	103 000
5.00	125	62 500	214	107 000
5.10	133	66 300	228	114 000
5.20	141	70 300	244	122 000
5.30	149	74 400	260	130 000
5.40	157	78 700	276	138 000
5.50	166	83 200	294	147 000
5.60	176	87 800	312	156 000
5.70	185	92 600	331	165 000
5.80	195	97 600	351	175 000
5.90	205	103 000	371	186 000
6.00	216	108 000	392	196 000
6.50	275	137 000	513	256 000
7.00	343	172 000	656	328 000
7.50	422	211 000	826	413 000
8.00	512	256 000	1 020	512 000
8.50	614	307 000	1 250	627 000
9.00	729	365 000	1 520	758 000
9.50	857	429 000	1 820	908 000
10.0	1 000	—	2 150	—
11.0	1 330	—	2 960	—
12.0	1 730	—	3 960	—
13.0	2 200	—	5 170	—
14.0	2 740	—	6 610	—
15.0	3 380	—	8 320	—

Index of Inch Design Tapered Roller Bearings

Index Table Index of Inch Design Tapered Roller Bearings

Bearing No. CONE / CUP	ANSI/ ABMA TYPE	Pages	Bearing No. CONE / CUP	ANSI/ ABMA TYPE	Pages
687 / 672A	TS	B115	9977D / 9920+K	TDI	B269
687 / 672D+L	TDO	B183	29875 / 29819	TS	B159
687 / 672	TS	B115	29875 / 29820	TS	B159
NA691 / 672D	TNA	B253	29875 / 29820D+L	TDO	B219
780 / 772	TS	B115	29880 / 29820	TS	B161
780 / 773D+L	TDO	B183	36690 / 36620D+L	TDO	B195
780 / 774D+L	TDO	B183	36690 / 36620	TS	B135
NA780 / 773D	TNA	B253	36691 / 36620	TS	B135
NA780 / 774D	TNA	B253	36990 / 36920D+L	TDO	B205
782 / 772	TS	B117	36990 / 36920	TS	B143
782 / 773D+L	TDO	B185	37425 / 37625	TS	B119
782 / 774D+L	TDO	B185	38880 / 38820	TS	B161
NA782 / 773D	TNA	B253	38885 / 38820	TS	B161
NA782 / 774D	TNA	B253	46780 / 46720	TS	B139
783 / 772	TS	B115	46780 / 46720D+L	TDO	B199
783 / 774D+L	TDO	B183	46790 / 46720	TS	B139
786 / 772	TS	B117	46790 / 46720D+L	TDO	B201
786 / 774D+L	TDO	B185	NA46790 / 46720D	TNA	B257
787 / 772	TS	B117	46790D / 46720+K	TDI	B267
795 / 792D+L	TDO	B189	NA46791 / 46720D	TNA	B257
795 / 792	TS	B123	46792 / 46720	TS	B141
797 / 792D+L	TDO	B191	48190 / 48120	TS	B119
797 / 792	TS	B127	48282 / 48220	TS	B123
NA798 / 792D	TNA	B255	48286 / 48220D+L	TDO	B189
799 / 792D+L	TDO	B189	48286 / 48220	TS	B123
799 / 792	TS	B127	48290 / 48220D+L	TDO	B189
799A / 792D+L	TDO	B191	48290 / 48220	TS	B125
799A / 792	TS	B127	48290D / 48220+K	TDI	B263
861 / 854	TS	B117	NA48291 / 48220D	TNA	B255
861 / 854D+L	TDO	B183	48385 / 48320D+L	TDO	B191
NA861 / 854D	TNA	B253	48385 / 48320	TS	B129
863X / 854	TS	B115	48385 / 48328	TS	B129
868D / 854+K	TDI	B263	NA48390 / 48320D	TNA	B255
868D / 854X+K	TDI	B263	48393 / 48320D+L	TDO	B193
896 / 892	TS	B131	48393 / 48320	TS	B131
896 / 892D+L	TDO	B193	48506 / 48750	TS	B127
898 / 892	TS	B131	48680D / 48620+K	TDI	B265
898A / 892	TS	B131	48684 / 48620	TS	B133
936 / 932D+L	TDO	B185	48684 / 48620D+L	TDO	B195
936 / 932	TS	B119	48685 / 48620	TS	B133
938 / 932D+L	TDO	B187	NA48686 / 48620D	TNA	B255
938 / 932	TS	B121	52393 / 52618	TS	B115
NA938 / 932D	TNA	B253	52393 / 52638	TS	B115
938D / 932+K	TDI	B263	52400 / 52637D+L	TDO	B183
941 / 932D+L	TDO	B183	52400 / 52618	TS	B115
941 / 932	TS	B117	52400 / 52637	TS	B115
946D / 932+K	TDI	B263	52401 / 52618	TS	B115
8573 / 8520	TS	B153	56418 / 56650	TS	B117
8573 / 8520D+L	TDO	B215	56418 / 56650D+L	TDO	B185
8575 / 8520	TS	B115	56418 / 56662	TS	B117
8575 / 8520D+L	TDO	B215	56425 / 56650D+L	TDO	B185
8576D / 8520+K	TDI	B269	56425 / 56650	TS	B119
8578 / 8520	TS	B157	56425 / 56662	TS	B119
8578 / 8520D+L	TDO	B217	64433 / 64700D+L	TDO	B185

Bearing No. CONE / CUP	ANSI/ ABMA TYPE	Pages
64433 / 64700	TS	B119
64450 / 64700D+L	TDO	B187
64450 / 64700	TS	B121
64452 / 64700D+L	TDO	B187
64452 / 64700	TS	B121
67388 / 67320	TS	B125
67388 / 67322D+L	TDO	B189
67388 / 67322	TS	B125
67388 / 67325D+L	TDO	B189
67389 / 67320	TS	B127
67389 / 67322D+L	TDO	B191
67389 / 67322	TS	B127
67389 / 67325D+L	TDO	B191
67390 / 67320	TS	B129
67390 / 67322D+L	TDO	B191
67390 / 67322	TS	B129
67390 / 67325D+L	TDO	B191
67390D / 67322+K	TDI	B265
67391 / 67320	TS	B129
67391 / 67322D+L	TDO	B191
67391 / 67322	TS	B129
67780 / 67720D+L	TDO	B201
67780 / 67720	TS	B139
67782 / 67720D+L	TDO	B203
67782 / 67720	TS	B141
67787 / 67720D+L	TDO	B205
67787 / 67720	TS	B143
NA67787 / 67720D	TNA	B257
67790 / 67720D+L	TDO	B205
67790 / 67720	TS	B143
NA67790 / 67720D	TNA	B257
67790D / 67720+K	TDI	B267
67791 / 67720D+L	TDO	B205
67791 / 67720	TS	B143
67883 / 67820	TS	B145
67883 / 67820D+L	TDO	B207
67883 / 67820	TS	B147
67884 / 67820	TS	B145
67884 / 67820D+L	TDO	B207
67885 / 67820	TS	B147
67885 / 67820D+L	TDO	B209
67983 / 67920D+L	TDO	B211
67983 / 67920	TS	B149
67985 / 67920D+L	TDO	B211
67985 / 67920	TS	B151
67985D / 67920+K	TDI	B269
67989 / 67920	TS	B151
68450 / 68709	TS	B121
68450 / 68712	TS	B121
68462 / 68712	TS	B123
71412 / 71750	TS	B117
71412 / 71751D+L	TDO	B185
71425 / 71750	TS	B119
71425 / 71751D+L	TDO	B185
71426D / 71750+K	TDI	B263

Bearing No. CONE / CUP	ANSI/ ABMA TYPE	Pages
71432 / 71750	TS	B119
71432 / 71751D+L	TDO	B185
71437 / 71750	TS	B121
71437 / 71751D+L	TDO	B187
71450 / 71750	TS	B121
NA71450 / 71751D	TNA	B253
71450D / 71750+K	TDI	B263
71453 / 71750	TS	B123
73551 / 73875	TS	B131
73551 / 73876D+L	TDO	B193
74472 / 74846X	TS	B123
74472 / 74850	TS	B123
74500 / 74850	TS	B125
74500 / 74851D+L	TDO	B189
74500 / 74856	TS	B125
74510D / 74850+K	TDI	B265
74512D / 74850+K	TDI	B265
74525 / 74846X	TS	B129
74525 / 74850	TS	B129
74525 / 74851D+L	TDO	B193
74525 / 74856	TS	B129
NA74525 / 74851D	TNA	B255
74537 / 74846X	TS	B131
74537 / 74850	TS	B131
74537 / 74851D+L	TDO	B193
74537 / 74856	TS	B131
74550 / 74850	TS	B131
74550 / 74851D+L	TDO	B193
74550A / 74846X	TS	B131
74551X / 74846X	TS	B133
74551X / 74850	TS	B133
74551X / 74856	TS	B133
76587 / 76520D+L	TDO	B221
76590 / 76520D+L	TDO	B221
80170 / 80217	TS	B175
80170 / 80222	TS	B175
80176 / 80217	TS	B175
80176 / 80222	TS	B175
80385 / 80325	TS	B175
80480 / 80425	TS	B177
80780 / 80720	TS	B179
NA81550 / 81963D	TNA	B255
81575 / 81962	TS	B135
81575 / 81963D+L	TDO	B197
81590 / 81962	TS	B137
81593 / 81963D+L	TDO	B199
81600 / 81962	TS	B137
81600 / 81963D+L	TDO	B199
NA81600 / 81963D	TNA	B257
81601D / 81962+K	TDI	B265
81606 / 81962	TS	B137
81629 / 81962	TS	B139
81629 / 81963D+L	TDO	B201

Index of Inch Design Tapered Roller Bearings

Bearing No. CONE / CUP	ANSI/ ABMA TYPE	Pages
81637/81962	TS	B139
82550/82931	TS	B131
85550/82932D+L	TDO	B193
82550/82950	TS	B133
82550/82951D+L	TDO	B193
82562/82931	TS	B133
82562/82932D+L	TDO	B195
82562/82950	TS	B135
82562/82951D+L	TDO	B195
82576/82931	TS	B135
82576/82932D+L	TDO	B195
82576/82950	TS	B135
NA82576/82932D	TNA	B255
NA82576/82951D	TNA	B255
82587/82931	TS	B137
82587/82932D+L	TDO	B197
82587/82950	TS	B137
82587/82951D+L	TDO	B197
NA82587/82932D	TNA	B255
NA82587/82951D	TNA	B255
82587D/82931+K	TDI	B265
82680D/82620+K	TDI	B267
84115/84155	TS	B165
86650/86100	TS	B139
86669/86100	TS	B141
NA87700/87112D	TNA	B257
87737/87111	TS	B145
87750/87111	TS	B147
87750/87112D+L	TDO	B209
87762/87111	TS	B147
88900/88126	TS	B153
88900/88128	TS	B153
88925/88126	TS	B155
88925/88128	TS	B155
89111D/89150+K	TDI	B285
EE91702/91112	TS	B143
EE91702/91113XD+L	TDO	B205
93708/93125	TS	B145
93708/93126	TS	B145
93708/93127D+L	TDO	B207
93708/93128XD+L	TDO	B207
93750/93125	TS	B147
93750/93126	TS	B147
93750/93127D+L	TDO	B209
93751D/93125+K	TDI	B267
93775/93125	TS	B147
93775/93126	TS	B147
93775/93127D+L	TDO	B209
93787/93125	TS	B149
93787/93126	TS	B149
93788D/93125+K	TDI	B267
93800/93125	TS	B149
93800/93126	TS	B149
93800/93127D+L	TDO	B211

Bearing No. CONE / CUP	ANSI/ ABMA TYPE	Pages
93800/93128D+L	TDO	B211
NA93800/93127D	TNA	B259
93800A/93125	TS	B149
93800A/93126	TS	B149
93801D/93125+K	TDI	B269
93825/93125	TS	B151
93825/93126	TS	B151
93825/93127D+L	TDO	B213
93825A/93125	TS	B151
93825A/93126	TS	B151
94649/94113	TS	B139
94649/94114D+L	TDO	B203
94649/94118	TS	B139
94649/94118D+L	TDO	B203
94650/94114D+L	TDO	B203
NA94650/94114D	TNA	B257
NA94650/94118D	TNA	B257
94675/94113	TS	B141
94675/94114D+L	TDO	B203
94675/94118	TS	B141
94675/94118D+L	TDO	B203
94687/94113	TS	B143
94687/94118	TS	B143
94700/94113	TS	B143
94700/94114D+L	TDO	B205
94700/94118D+L	TDO	B205
NA94700/94114D	TNA	B257
NA94700/94118D	TNA	B259
94706D/94113+K	TDI	B267
94706D/94118+K	TDI	B267
95474D/95925+K	TDI	B263
95475/95925	TS	B123
95491/95925	TS	B125
95491/95927D+L	TDO	B189
95499D/95925+K	TDI	B263
95500/95927D+L	TDO	B189
95500/95975	TS	B127
95500/95925	TS	B125
NA95500/95927D	TNA	B255
95502/95925	TS	B125
95525/95925	TS	B129
95525/95927D+L	TDO	B193
95525/95928	TS	B129
95525/95975	TS	B129
95528/95925	TS	B129
95528/95927D+L	TDO	B193
95528/95928	TS	B129
95528/95975	TS	B129
96825/96140	TS	B151
96825/96140D+L	TDO	B213
96851D/96140+K	TDI	B283
96900/96140	TS	B153
96900/96140D+L	TDO	B215
96925/96140	TS	B155

Bearing No. CONE / CUP	ANSI/ ABMA TYPE	Pages
96925/96140D+L	TDO	B215
97450/97900	TS	B121
97450/97901D+L	TDO	B247
NA97450/97901D	TNA	B253
97472X/97905X	TS	B123
97493/97901D+L	TDO	B247
97500/97900	TS	B125
97500/97901D+L	TDO	B247
97500D/97900+K	TDI	B283
98400/98788	TS	B117
98400/98789D+L	TDO	B183
99537/99100	TS	B131
99537/99101D+L	TDO	B193
99550/99098X	TS	B133
99550/99100	TS	B133
99550/99101D+L	TDO	B193
99550/99102D+L	TDO	B193
99575/99100	TS	B135
99575/99102D+L	TDO	B197
99587/99102D+L	TDO	B197
99600/99100	TS	B137
99600/99101D+L	TDO	B199
99600/99102D+L	TDO	B199
NA99600/99102D	TNA	B257
99603D/99100+K	TDI	B265
EE101103/101600	TS	B163
EE101103/101601D+L	TDO	B223
NA101103/101601D	TNA	B261
EE107057/107105	TS	B135
EE107057/107105D+L	TDO	B197
EE107060/107105	TS	B137
EE107060/107105D+L	TDO	B199
EE108065/108142	TS	B141
EE109120/109163D+L	TDO	B225
EE111175/111700	TS	B165
EE113089/113170	TS	B153
EE113089/113171D+L	TDO	B249
EE113090D/113170+K	TDI	B283
EE113091/113170	TS	B153
EE113091/113171D+L	TDO	B249
EE114080/114160	TS	B151
EE114080/114161D+L	TDO	B249
EE116050/116097	TS	B127
EE117063/117148	TS	B139
EE117063/117148D+L	TDO	B249
EE122080/122125	TS	B149
EE125094/125145	TS	B157
EE125095/125145	TS	B157
EE126097/126150	TS	B157
EE126097/126151D+L	TDO	B217
EE126098/126151D+L	TDO	B217
EE127094D/127140+K	TDI	B271
EE127095/127135	TS	B157
EE127095/127136D+L	TDO	B217

Bearing No. CONE / CUP	ANSI/ ABMA TYPE	Pages
EE127095/127137D+L	TDO	B217
EE127095/127139D+L	TDO	B217
EE127095/127140	TS	B157
NA127096/127136D	TNA	B259
EE127097D/127135+K	TDI	B271
EE128102/128160	TS	B161
EE128102/128160D+L	TDO	B221
EE128111/128160	TS	B163
EE128111/128160D+L	TDO	B223
EE128111/128161	TS	B163
EE128114/128160D+L	TDO	B223
EE129121D/129172+K	TDI	B273
EE129123D/129172+K	TDI	B273
EE130787/131400	TS	B149
EE130787/131401D+L	TDO	B211
EE130787/131402D+L	TDO	B211
EE130851/131400	TS	B153
EE130851/131401D+L	TDO	B213
EE130888D/131400+K	TDI	B269
EE130889/131400	TS	B153
EE130889/131401D+L	TDO	B213
EE130902/131400	TS	B155
EE130902/131401D+L	TDO	B215
EE130902/131402D+L	TDO	B215
NA130902/131401D	TNA	B259
EE130903D/131400+K	TDI	B269
EE132083/132125	TS	B149
EE132083/132126D+L	TDO	B211
NA132083/132126D	TNA	B259
EE132084/132125	TS	B151
EE132084/132126D+L	TDO	B211
EE134100/134143	TS	B159
EE134100/134144D+L	TDO	B219
EE134100/134145	TS	B159
EE134102/134143	TS	B161
EE134102/134144D+L	TDO	B219
EE134102/134145	TS	B161
EE134103D/134143+K	TDI	B271
HH144642/HH144614	TS	B149
EE147112/147198D+L	TDO	B249
EE148122/148221D+L	TDO	B249
EE153050/153100	TS	B127
EE153050/153103D+L	TDO	B189
EE153053D/153100+K	TDI	B263
EE161300/161850	TS	B167
EE161300/161900	TS	B167
EE161300/161901D+L	TDO	B227
EE161300/161925	TS	B167
EE161363/161850	TS	B169
EE161363/161900	TS	B169
EE161363/161901D+L	TDO	B229
EE161363/161925	TS	B169
EE161394/161850	TS	B169
EE161394/161900	TS	B169

Index of Inch Design Tapered Roller Bearings

Bearing No. CONE / CUP	ANSI/ ABMA TYPE	Pages
EE161394/161925	TS	B169
EE161400/161850	TS	B169
EE161400/161900	TS	B169
EE161400/161901D+L	TDO	B229
EE161400/161925	TS	B169
L163149/L163110	TS	B169
L163149/L163110D+L	TDO	B229
L163149D/L163110+K	TDI	B275
EE170950/171400	TS	B157
EE170950/171450	TS	B157
NA170950/171451D	TNA	B259
EE170975/171400	TS	B159
EE170975/171450	TS	B159
EE171000D/171400+K	TDI	B271
EE175301/175350	TS	B181
EE181453/182350	TS	B171
EE181453/182351D+L	TDO	B229
EE192148/192200	TS	B171
EE192150/192200	TS	B171
EE192150/192201D+L	TDO	B231
EE203130/203190	TS	B167
EE203136/203190	TS	B169
EE203137/203190	TS	B169
EE215040/215098	TS	B117
EE219065/219122	TS	B141
EE219068/219117	TS	B143
EE221026/221575	TS	B161
EE221026/221576D+L	TDO	B219
NA221026/221576D	TNA	B261
HH221449/HH221410	TS	B117
HH221449/HH221410D+L	TDO	B183
HH221449/HH221416	TS	B117
HH221449NA/HH221410D	TNA	B253
EE222070/222126	TS	B145
EE222070/222127D+L	TDO	B205
EE222070/222128	TS	B145
NA222075/222127D	TNA	B259
EE224115/224205D+L	TDO	B225
HH224334/HH224310	TS	B115
HH224335/HH224310	TS	B117
HH224335/HH224310D+L	TDO	B183
HH224340/HH224310	TS	B119
HH224340/HH224310D+L	TDO	B185
HH224346/HH224310	TS	B121
HH224346/HH224310D+L	TDO	B187
HH224346DD/HH224310+K	TDI	B263
HH224346NA/HH224310D	TNA	B253
HH224349/HH224310	TS	B121
HH224349/HH224310D+L	TDO	B187
M224748/M224710D+L	TDO	B187
M224748/M224710	TS	B189
M224748/M224710	TS	B123
M224749/M224710D+L	TDO	B189
LL225749/LL225710	TS	B125
L225849/L225810	TS	B125

Bearing No. CONE / CUP	ANSI/ ABMA TYPE	Pages
L225849/L225818	TS	B125
HH228340/HH228310	TS	B123
HH228349/HH228310	TS	B127
H228649D/H228610+K	TDI	B265
HM231132/HM231110	TS	B131
HM231132/HM231111D+L	TDO	B193
HM231132/HM231115	TS	B133
HM231132/HM231116D+L	TDO	B193
HM231136/HM231110	TS	B133
HM231136/HM231115	TS	B133
HM231140/HM231110	TS	B135
HM231140/HM231111D+L	TDO	B195
HM231140/HM231115	TS	B135
HM231140/HM231115	TS	B135
HM231140NA/171400+K	TDI	B271
HM231140NA/171400+K	TDI	B271
HM231140NA/HM231111D	TNA	B255
HM231140NA/HM231116D	TNA	B255
HM231148/HM231110	TS	B137
HM231148/HM231111D+L	TDO	B197
HM231148/HM231115	TS	B137
HM231149/HM231110	TS	B137
HM231149/HM231111D+L	TDO	B197
HM231149/HM231115	TS	B137
HM231149/HM231116D+L	TDO	B197
HM231149NA/171400+K	TNA	B255
HM231149NA/HM231111D	TNA	B255
EE231400/231975	TS	B171
EE231400/231975D+L	TDO	B229
EE231400/232025	TS	B171
NA231400/231976D	TNA	B261
NA231400/232026D	TNA	B261
EE231462/231975	TS	B171
EE231462/231976D+L	TDO	B231
EE231462/232025	TS	B171
EE231462/232026D+L	TDO	B231
HH231637/HH231610	TS	B127
HH231637/HH231615	TS	B127
M231648/M231610D+L	TDO	B199
M231649/M231610	TS	B137
M231649/M231610D+L	TDO	B199
M231649/M231611D+L	TDO	B199
HH231649/HH231610	TS	B133
HH231649/HH231615	TS	B133
M231649D/M231610+K	TDI	B265
HH234031/HH234010	TS	B133
HH234031/HH234018	TS	B133
HH234040/HH234010	TS	B135
HH234040/HH234011D+L	TDO	B197
HH234040/HH234018	TS	B135
HH234040D/HH234018+K	TDI	B265
HH234048/HH234010	TS	B137
HH234048/HH234011D+L	TDO	B199
HH234048/HH234018	TS	B137
HH234048D/HH234018+K	TDI	B265
EE234154/234213D+L	TDO	B231

Bearing No. CONE / CUP	ANSI/ ABMA TYPE	Pages
EE234154/234215 EE234154/234216D+L EE234154/234220	TS TDO TS	B173 B231 B173
EE234154/234223D+L EE234156/234213D+L EE234156/234215	TDO TDO TS	B231 B231 B173
EE234156/234216D+L EE234156/234220 EE234157D/234215+K	TDO TS TDI	B231 B173 B275
EE234160/234213D+L EE234160/234215 EE234160/234216D+L	TDO TS TDO	B233 B173 B233
EE234160/234220 EE234161D/234215+K M235145/M235113	TS TDI TS	B173 B277 B139
M235145/M235113D+L M235149/M235113 M235149/M235113D+L	TDO TS TDO	B201 B141 B203
M236849/M236810 HM237532/HM237510 HM237532/HM237510D+L	TS TS TDO	B143 B139 B201
HM237535/HM237510 HM237535/HM237510D+L HM237535/HM237511D+L	TS TDO TDO	B139 B201 B203
HM237536NA/HM237510D HM237542/HM237510 HM237542/HM237510D+L	TNA TS TDO	B257 B143 B205
HM237542/HM237511D+L HM237542D/HM237510+K HM237545/HM237510	TDO TDI TS	B205 B267 B143
HM237545/HM237510D+L HM237545/HM237511D+L HM237545/HM237511XD+L	TDO TDO TDO	B205 B205 B205
HM237545NA/HM237510D HM237546D/HM237510+K HM237546DD/HM237510+K	TNA TDI TDI	B257 B267 B267
H238140/H238110 H238148/H238110 M238840/M238810	TS TS TS	B141 B143 B143
M238840/M238810D+L M238849/M238810D+L M238849/M238810	TDO TDO TS	B205 B207 B145
EE239171D/239225+K H239640/H239610 H239640/H239612	TDI TS TS	B277 B145 B145
H239640/H239612D+L H239649/H239610 H239649/H239612	TDO TS TS	B207 B145 B145
H239649/H239612D+L H239649D/H239612+K H239649NA/H239612D	TDO TDI TNA	B207 B267 B259
LM241149/LM241110 LM241149/LM241110D+L LM241149NW/LM241110D	TS TDO TNA	B149 B211 B259

Bearing No. CONE / CUP	ANSI/ ABMA TYPE	Pages
M241547/M241510D+L M241549/M241510 EE241693/242375	TDO TS TS	B211 B151 B175
EE241701/242375 H242649/H242610 H242649/H242610D+L	TS TS TDO	B175 B151 B211
H242649D/H242610+K EE243190/243250 EE243190/234251D+L	TDI TS TDO	B269 B177 B237
EE243192/243250 EE243192/243251D+L EE243196/243250	TS TDO TS	B177 B237 B177
EE243196/243251D+L EE244180/244235 EE244180/244236D+L	TDO TS TDO	B237 B175 B235
EE244181D/244235+K M244249/M244210 M244249/M244210D+L	TDI TS TDO	B277 B153 B213
M244249D/M244210+K H244849D/H244810+K M246942/M246910	TDI TDI TS	B269 B269 B155
M246949/M246910 H247535/H247510 H247535/H247510D+L	TS TS TDO	B157 B149 B211
H247549/H247510 H247549/H247510D+L H247549D/H247510+K	TS TDO TDI	B157 B215 B269
LM247748D/LM247710+K H249148/H249111D+L M249734/M249710	TDI TDO TS	B271 B217 B155
M249736/M249710 LM249747NW/LM249710D LM249748/LM249710D+L	TS TNA TDO	B157 B259 B219
M249748D/M249710+K M249749/M249710 M249749/M249710D+L	TDI TS TDO	B271 B159 B219
HH249949/HH249910 HH249949D/HH249910+K EE251001/251575	TS TDI TS	B159 B271 B159
LM251649NW/LM251610D HM252343/LM252310 HM252343/HM252310D+L	TNA TS TDO	B261 B159 B219
HM252343/HM252311D+L HM252343/HM252315 HM252343NA/HM252315D	TDO TS TNA	B219 B159 B261
HM252344NA/HM252311D M252349/M252310 M252349/M252310D+L	TNA TS TDO	B261 B163 B221
HM252349/HM252310 HM252349/HM252310D+L HM252349/HM252311D+L	TS TDO TDO	B161 B221 B221
HM252349/HM252315 M252349D/M252310+K HM252349NA/HM252315D	TS TDI TNA	B161 B271 B261

Index of Inch Design Tapered Roller Bearings

Bearing No. CONE / CUP	ANSI/ ABMA TYPE	Pages
M255449/M255410 M255449/M255410D+L HM256849/HM256810	TS TDO TS	B163 B223 B165
HM256849/HM256810D+L HM256849D/HM256810+K LM256649D/LM258610+K	TDO TDI TDI	B225 B273 B273
HM259049/HM259010 HM259049/HM259010D+L HM259049D/HM259010+K	TS TDO TDI	B167 B227 B273
HM261049/HM261010D+L EE261650D/262450+K HM262749/HM262710	TDO TDI TS	B227 B277 B169
HM262749/HM262710D+L HM262749D/HM262710+K LM263149D/LM263110+K	TDO TDI TDI	B229 B275 B275
HM265049D/HM265010+K HM266445D/HM266410+K HM266447/HM266410	TDI TDI TS	B275 B275 B171
HM266447/HM266410D+L HM266449/HM266410 HM266449/HM266410D+L	TDO TS TDO	B231 B171 B231
HM266449D/HM266410+K M268749/M268710D+L M270749/M270710	TDI TDO TS	B275 B233 B175
M270749/M270710D+L M270749D/M270710+K LM272249/LM272210	TDO TDI TS	B235 B277 B177
LM272249/LM272210D+L M272749/M272710 M272749D/M272710D+L	TDO TS TDO	B237 B177 B235
M272749D/M272710+K EE275095/275155 EE275095/275156D+L	TDI TS TDO	B279 B157 B217
EE275095/275160 EE275095/275161D+L EE275100/275155	TS TDO TS	B157 B217 B159
EE275100/275156D+L EE275100/275160 EE275105/275155	TDO TS TS	B219 B159 B161
EE275105/275156D+L EE275105/275160 EE275105/275161D+L	TDO TS TDO	B221 B163 B221
EE275108/275155 EE275108/275156D+L EE275108/275160	TS TDO TS	B163 B223 B163
EE275108/275161D+L M275349D/M275310+K M276449D/M276410+K	TDO TDI TDI	B223 B279 B279
EE277455/277565 M278749/M278710 M278749D/M278710+K	TS TS TDI	B181 B179 B279
M280049D/M280010+K EE280702/281200 L281148/L281110	TDI TS TS	B279 B143 B179

Bearing No. CONE / CUP	ANSI/ ABMA TYPE	Pages
LM283649/LM283610 EE285160/285226 EE285160/285228D+L	TS TS TDO	B181 B173 B233
NA285160/285228D EE285162/285226 EE285162/285228D+L	TNA TS TDO	B261 B173 B233
LM286249D/LM286210+K LM287849D/LM287810+K EE291175/291749	TDI TDI TS	B281 B281 B165
EE291175/291750 EE291175/291751D+L EE291201/291749	TS TDO TS	B165 B225 B165
EE291201/291750 EE291201/291751D+L NA291201/291751D	TS TDO TNA	B165 B225 B261
EE291250/291749 EE291250/291750 EE291250/291751D+L	TS TS TDO	B167 B167 B227
EE295102/295192D+L EE295102/295193 EE295110/295192D+L	TDO TS TDO	B221 B161 B223
EE295110/295193 EE295950/295192D+L EE295950/295193	TS TDO TS	B163 B217 B157
EE299615/299711D+L EE321145/321240 EE323166D/323290+K	TDO TS TDI	B245 B171 B277
L327249/L327210D+L L327249/L327210 EE328167/328268D+L	TDO TS TDO	B191 B129 B233
EE328167/328269 LM328448/LM328410 NA329116/329173D	TS TS TNA	B173 B131 B261
EE329117D/329172+K NA329120/329173D EE333137/333197	TDI TNA TS	B273 B261 B169
EE333137/333203D+L EE333140/333197 EE333140/333203D+L	TDO TS TDO	B229 B169 B229
EE342043/342091D+L M349549/M349510 EE350750/351687	TDO TS TS	B185 B161 B147
L357049/L357010 L357049/L357010D+L L357049NW/L357010D	TS TDO TNA	B165 B225 B261
LM361649/LM361610 LL365348/LL365310 LM377449/LM377410	TS TS TS	B167 B171 B179
LM377449/LM377410D+L LM377449D/LM377410+K EE380080/380190	TDO TDI TS	B239 B279 B151
M383240D/M383210+K EE390090/390200 EE390095/390200	TDI TS TS	B281 B155 B157

Bearing No. CONE / CUP	ANSI/ ABMA TYPE	Pages
EE420651/421417	TS	B141
EE420651/421451D+L	TDO	B203
EE420701/421437	TS	B145
EE420701/421450	TS	B145
EE420701/421451D+L	TDO	B207
EE420751/421450	TS	B147
EE420793/421417	TS	B149
EE420793/421451D+L	TDO	B211
EE420800D/421437+K	TDI	B269
EE420801/421417	TS	B151
EE420801/421437	TS	B151
EE420801/421450	TS	B151
EE420801/421451D+L	TDO	B211
EE426200/426331D+L	TDO	B237
LL428349/LL428310	TS	B131
EE430888/431575	TS	B153
EE430888/431576D+L	TDO	B213
EE430900/431575	TS	B155
EE430900/431576D+L	TDO	B215
EE430902/431575	TS	B155
L432349/L432310	TS	B139
H432549D/H432510+K	TDI	B267
L433749/L433710	TS	B139
L433749/L433710D+L	TDO	B201
EE435102/435165	TS	B161
EE435103D/435165+K	TDI	B285
HH437549/HH437510	TS	B141
LM446349/LM446310D+L	TDO	B215
LM446349NW/LM446310D	TNA	B259
EE450577/451212	TS	B135
EE450601/451212	TS	B137
EE450601/451215D+L	TDO	B199
LM451345/LM451310	TS	B161
LM451349/LM451310	TS	B161
LM451349/LM451310D+L	TDO	B221
LM451349/LM451312D+L	TDO	B221
EE455048D/455116+K	TDI	B265
L467549/L467510	TS	B173
EE470075/470128	TS	B147
EE470078/470128	TS	B145
L476549/L476510	TS	B179
LL481448/LL481411	TS	B181
LL483449/LL483418	TS	B181
EE517060D/517117+K	TDI	B265
L521945/L521910	TS	B115
L521949/L521910D+L	TDO	B185
EE522102/523087	TS	B177
EE522102/523088D+L	TDO	B239
LM522546/LM522510	TS	B119
LM522548/LM522510	TS	B119
LM522549/LM522510	TS	B119
JHM522649/JHM522610	TS	B119
EE526130/526190	TS	B167
EE526130/526191D+L	TDO	B227

Bearing No. CONE / CUP	ANSI/ ABMA TYPE	Pages
EE526132/526190	TS	B167
LL529749/LL529710	TS	B135
EE531201D/531300+K	TDI	B279
JHM534149/JHM534110	TS	B141
HM535349/HM535310	TS	B141
EE536136D/536225+K	TDI	B275
NA537075/537103D	TNA	B259
LL537649/LL537610	TS	B145
LL537649/LL537610D+L	TDO	B207
L540049/L540010	TS	B147
L540049/L540010D+L	TDO	B209
EE542215/542290	TS	B179
EE542215/542291D+L	TDO	B239
EE542220/542290	TDO	B179
EE542220/542291D+L	TDO	B239
543085/543114	TS	B153
543086/543114	TS	B153
544090/544116	TS	B153
544090/544118	TS	B153
544091/544116	TS	B155
544091/544118	TS	B155
545112/545141	TS	B163
545112/545142D+L	TDO	B223
LM545849/LM545810	TS	B155
EE551002/551664D+L	TDO	B219
EE551002/551701D+L	TDO	B219
NA551002/551701D	TNA	B261
EE551026/551662	TS	B161
EE551026/551663D+L	TDO	B221
EE551050/551662	TS	B163
EE551050/551663D+L	TDO	B221
EE551050/551701D+L	TDO	B221
L555249/L555210	TS	B165
LM565943/LM565910	TS	B171
LM565946/LM565910	TS	B171
LM565949/LM565910	TS	B171
LM567943/LM567910	TS	B173
LM567949/LM567910	TS	B173
L570649/L570610	TS	B175
EE571602/572650	TS	B173
EE571602/572651D+L	TDO	B233
EE571703/572650	TS	B175
EE571703/572651D+L	TDO	B235
EE571703/572653D+L	TDO	B235
LL575343/LL575310	TS	B177
LL575349/LL575310	TS	B177
LL579749/LL579710D+L	TDO	B177
L580049/L580010	TS	B241
EE618065/618136D+L	TDO	B203
L623149/L623110	TS	B121
EE623161D/623265+K	TDI	B277
L624549/L624510	TS	B123
EE626210/626321D+L	TDO	B239
LL639249/LL639210	TS	B147

Index of Inch Design Tapered Roller Bearings

Bearing No. CONE / CUP	ANSI/ ABMA TYPE	Pages
EE640191/640260	TS	B177
EE640191/640261D+L	TDO	B237
EE640192/640260	TS	B177
EE640192/640261D+L	TDO	B237
LL641149/LL641110	TS	B149
EE649237/649310	TS	B179
EE649237/649311D+L	TDO	B241
EE649237/649313D+L	TDO	B241
EE649239/649310	TS	B179
EE649239/649311D+L	TDO	B241
EE649240/649310	TS	B179
EE649240/649311D+L	TDO	B241
EE649240/649313D+L	TDO	B241
EE649241D/649310+K	TDI	B281
LM654645D/LM654610+K	TDI	B273
LM654648D/LM654610+K	TDI	B273
LM654649/LM654610	TS	B163
LM654649/LM654610D+L	TDO	B223
EE655270/655345	TS	B181
EE655270/655346D+L	TDO	B243
LM665949/LM665910	TS	B171
M667944/M667910D+L	TDO	B233
M667944/M667911D+L	TDO	B233
EE671801/672875D+L	TDO	B235
680235/680270	TS	B179
LL686947/LL686910D+L	TDO	B245
LL687949/LL687910	TS	B181
LL687949/LL687910D+L	TDO	B245
EE700090D/700167+K	TDI	B269
EE700091/700167	TS	B155
EE700091/700168D+L	TDO	B215
JM720249/JM720210	TS	B115
JHM720249/JHM720210	TS	B115
EE722110/722185	TS	B163
EE722110/722186D+L	TDO	B223
EE722111D/722185+K	TDI	B273
EE722115/722185	TS	B165
EE722115/722186D+L	TDO	B225
EE724120/724195	TS	B165
EE724120/724196D+L	TDO	B225
JL724348/JL724314	TS	B123
JL725346/JL725316	TS	B125
JM734449/JM734410	TS	B141
LL735449/LL735410	TS	B143
EE736160/736239D+L	TDO	B233
EE737173/737261D+L	TDO	B235
EE737181/737260	TS	B175
EE737181/737261D+L	TDO	B235
EE738101D/738172+K	TDI	B271
JM738249/JM738210	TS	B147
LM739749/LM739710	TS	B147
LM742745/LM742710	TS	B153
LM742745/LM742710D+L	TDO	B213
LM742749/LM742710	TS	B153

Bearing No. CONE / CUP	ANSI/ ABMA TYPE	Pages
LM742749/LM742710D+L	TDO	B213
EE743240/743321D+L	TDO	B241
HM743337/HM743310	TS	B149
HM743345/HM743310	TS	B151
HM743345/HM743310D+L	TDO	B213
HM746646/HM746610	TS	B155
HM746646/HM746610D+L	TDO	B215
EE749260/749336	TS	B179
EE750502/751200	TS	B127
EE750576/751204D+L	TDO	B197
EE752300/752380	TS	B181
EE752300/752381D+L	TDO	B243
EE752300/752381D+L	TDO	B243
EE752305/752380	TS	B181
EE752305/752381D+L	TDO	B243
EE755280/755360	TS	B181
EE755280/755361D+L	TDO	B243
EE755285/755360	TS	B181
EE755285/755361D+L	TDO	B243
LM757049/LM757010	TS	B165
EE762320/762401D+L	TDO	B243
EE762320/762420XD+L	TDO	B243
EE763330/763410	TS	B181
LM767749D/LM767710+K	TDI	B277
L770849D/L770810+K	TDI	B277
LM770945/LM770910	TS	B175
LM770949/LM770910	TS	B175
LL771948/LL771911	TS	B175
LM772748/LM772710	TS	B177
LM772748/LM772710D+L	TDO	B237
LM772749D/LM772710+K	TDI	B279
EE776430/776520	TS	B181
LL778149/LL778110	TS	B179
LL788349/LL788310	TS	B181
EE790114/790221	TS	B165
EE790114/790223D+L	TDO	B225
EE790119D/790221+K	TDI	B273
EE790120/790221	TS	B165
EE790120/790223D+L	TDO	B225
JLM820048/JLM820012	TS	B115
EE820085/820161D+L	TDO	B213
JM822049/JM822010	TS	B119
EE822100/822175	TS	B159
EE822101D/822175+K	TDI	B271
HH840249/HH840210	TS	B147
JHM840449/JHM840410	TS	B147
EE843220/843290	TS	B179
EE843220/843291D+L	TDO	B239
EE843220/843292D+L	TDO	B239
H852849/H852810	TS	B163
L853049/L853010	TS	B163
HM858548D/HM858511+K	TDI	B273
H859049/H859010	TS	B167
L860048/L860010	TS	B167
L860049/L860010	TS	B167

Bearing No. CONE / CUP	ANSI/ ABMA TYPE	Pages
L865547/L865512	TS	B171
LM869448/LM869410	TS	B175
LM869448/LM869410D+L	TDO	B235
L879947/L879910	TS	B179
LL889049/LL889010	TS	B181
LL889049/LL889010D+L	TDO	B245
EE911600/912401D+L	TDO	B233
EE911618/912400	TS	B173
EE911618/912401D+L	TDO	B233
EE921124/921850	TS	B163
EE921124/921851D+L	TDO	B223
EE923095/923175	TS	B157
EE923095/923176D+L	TDO	B217
HH923649/HH923610	TS	B117
HH923649/HH923611	TS	B117
H924045/H924010	TS	B121
H924045/H924010D+L	TDO	B247
HH924349/HH924310D+L	TDO	B247
EE925179D/925295+K	TDI	B277
HM926740/HM926710	TS	B121
HM926740/HM926710D+L	TDO	B247
HH926744/HH926710	TS	B121
HH926744/HH926716	TS	B121
HH926745/HM926710	TS	B125
HM926747/HM926710	TS	B125
HM926747/HM926710D+L	TDO	B247
HH926749/HH926710	TS	B123
HH926749/HH926716	TS	B123
HM926749/HM926710	TS	B127
HM926749/HM926710D+L	TDO	B247
EE929225/929341D+L	TDO	B239
EE931170D/931250+K	TDI	B277
HH932132/HH932110	TS	B127
HH932145/HH932110	TS	B135
HH932145/HH932115	TS	B135
H936340/H936310	TS	B139
H936340/H936316	TS	B139
H936349/H936310	TS	B141
H936349/H936316	TS	B141
EE941002/941950	TS	B159
EE941002/941953D+L	TDO	B219
EE941205/941950	TS	B165
EE941205/941953D+L	TDO	B225
EE941206D/941950+K	TDI	B273
HH949549/HH949510	TS	B155
HH949549/HH949510D+L	TDO	B249
HH953749/HH953710	TS	B159
HH953749/HH953710D+L	TDO	B249
M959442/M959410	TS	B165
LM961548/LM961511D+L	TDO	B249
H961649/H961610	TS	B167
H961649/H961610D+L	TDO	B249
EE971298/972100	TS	B167
EE971298/972102D+L	TDO	B227

Bearing No. CONE / CUP	ANSI/ ABMA TYPE	Pages
EE971298/972103D+L	TDO	B227
EE971298/972151D+L	TDO	B227
EE971354/972100	TS	B167
EE971354/972102D+L	TDO	B229
EE971354/972103D+L	TDO	B229
EE971354/972151D+L	TDO	B229
EE971355D/972100+K	TDI	B275
EE981992/982900	TS	B177
EE981992/982901D+L	TDO	B237
EE982003/982900	TS	B177
EE982003/982901D+L	TDO	B237
EE982028/982900	TS	B177
EE982051/982900	TS	B177
EE982051/982901D+L	TDO	B239